

BT-SMARTZOOM

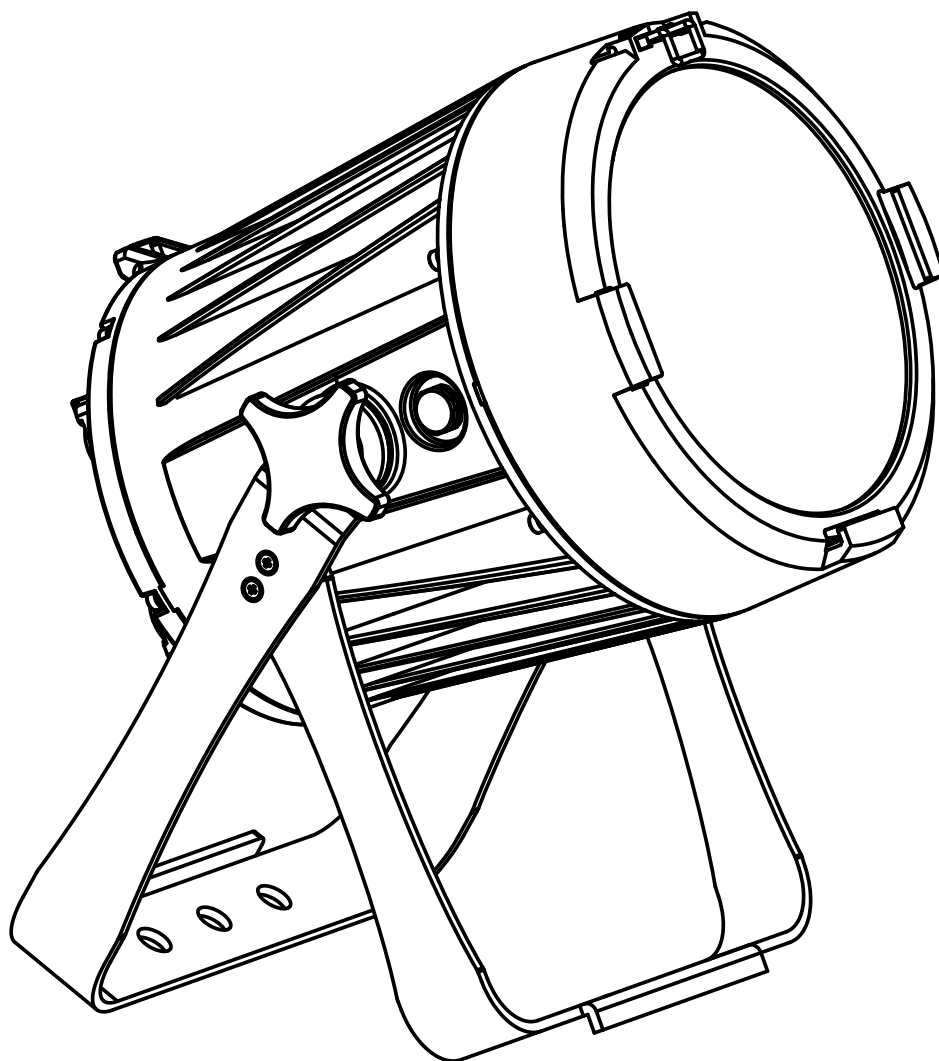

ZOOM
4.5° ~ 36°

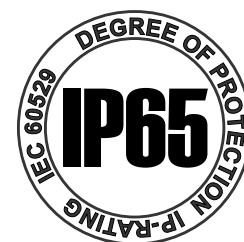

ENGLISH Operation Manual

WWW.BRITEQ-LIGHTING.COM

CE

Version: 1.0

BriteQ[®]
LIGHT RESEARCH



EN - DISPOSAL OF THE DEVICE

Dispose of the unit and used batteries in an environment friendly manner according to your country regulations.

FR - DÉCLASSER L'APPAREIL

Débarrassez-vous de l'appareil et des piles usagées de manière écologique conformément aux dispositions légales de votre pays.

NL - VERWIJDEREN VAN HET APPARAAT

Verwijder het toestel en de gebruikte batterijen op een milieuvriendelijke manier conform de in uw land geldende voorschriften.

DU - ENTSORGUNG DES GERÄTS

Entsorgen Sie das Gerät und die Batterien auf umweltfreundliche Art und Weise gemäß den Vorschriften Ihres Landes.

ES - DESHACERSE DEL APARATO

Reciclar el aparato y pilas usadas de forma ecologica conforme a las disposiciones legales de su país.

PT - COMO DESFAZER-SE DA UNIDADE

Tente reciclar a unidade e as pilhas usadas respeitando o ambiente e em conformidade com as normas vigentes no seu país.

1 PRODUCT SPECIFICATIONS

1.1 PRODUCT SPECIFICATIONS

- ◆ Voltage: AC100~240V, 50/60Hz
- ◆ Max Power: 130W
- ◆ Operation Temperature: -20°C~45°C
- ◆ Size: 376x274x210mm
- ◆ Weight: 7.3kg

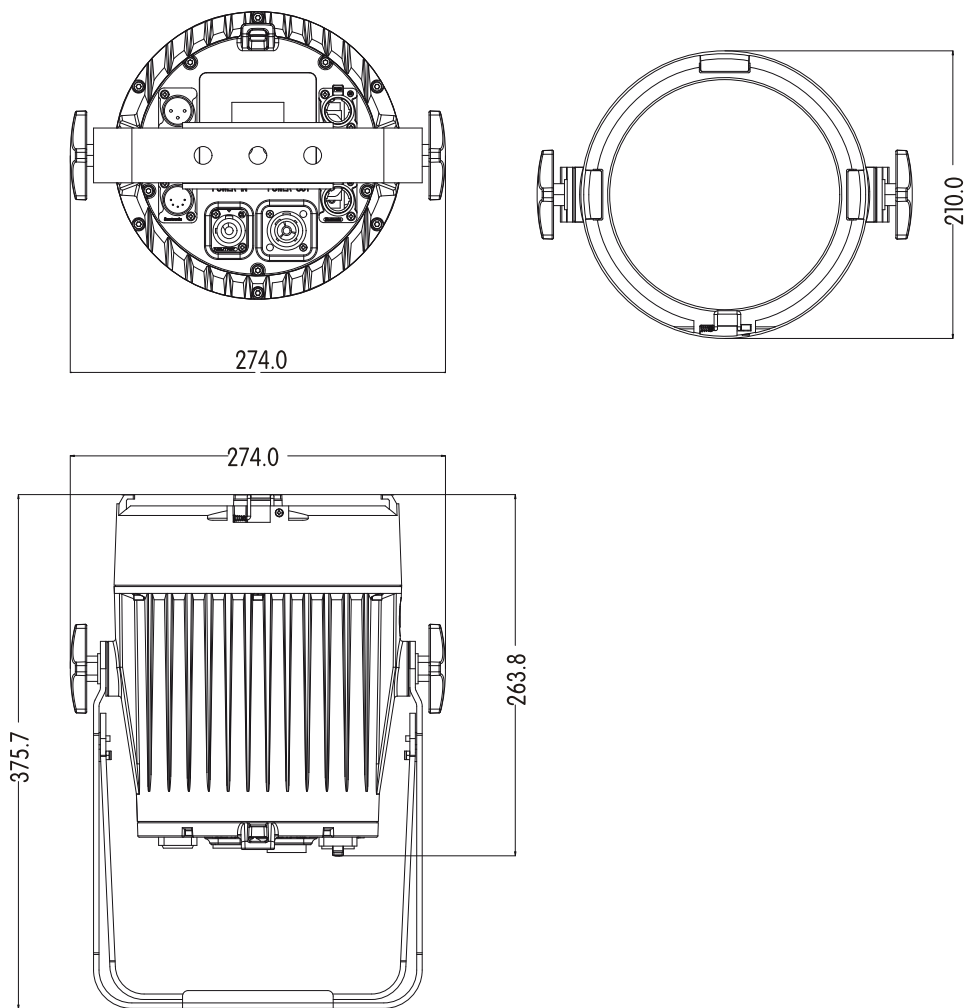

1.2 SAFETY WARNING

IMPORTANT:

- This product must be installed by a qualified professional.
- All maintenance must be carried out by a qualified electrician.
- A minimum distance of 0.5m must be maintained between the equipment and a combustible surface.
- The product must always be operated in a well ventilated area.
- DO NOT stare directly into the LED light source.
- Always disconnect the power before carrying out any maintenance.
- The earth must always be connected to the ground.
- Ensure that all parts of the equipment are kept clean and free of dust.

2 INSTALLATION

2.1 MOUNTING

HANGING

The fixture can be mounted in a hanging position using the supporting bracket. The bracket should be secured to the mounting truss or structure using a standard mounting clamp. Please note that when hanging the unit a safety cable should also be used.

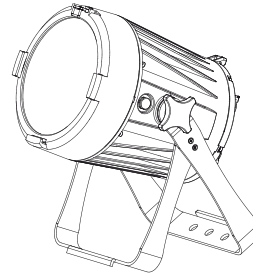

UPRIGHT

The fixture can be mounted in an upright or sitting position using the supporting brackets.

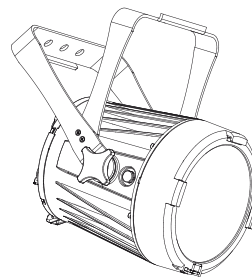

The LED MODULE can be mounted at any angle and in any position. It is possible to further adjust the angle of the LED MODULE using the two adjustment knobs located on the side of the fixture.

2.2 POWER CONNECTIONS

@ 220V: 15 units may be connected in series

@ 110V: 7 units may be connected in series

Note:

If the signal cable is over 60m between the DMX512 controller and fixture or between two fixtures, then a DMX signal amplifier is needed as well.

3 DISPLAY PANEL OPERATION

3.1 DISPLAY OPERATION

- ◆ MENU: BACK;
(Start display screen when press 3 seconds)
- ◆ ENTER: ENTER OR SAVE;
- ◆ DOWN: DOWN;
- ◆ UP: UP;

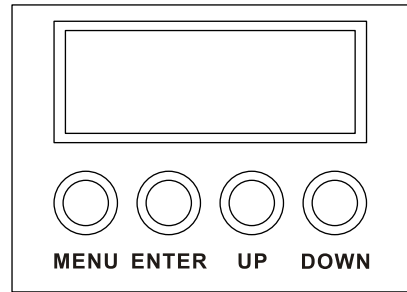

3.2 MENU MAP

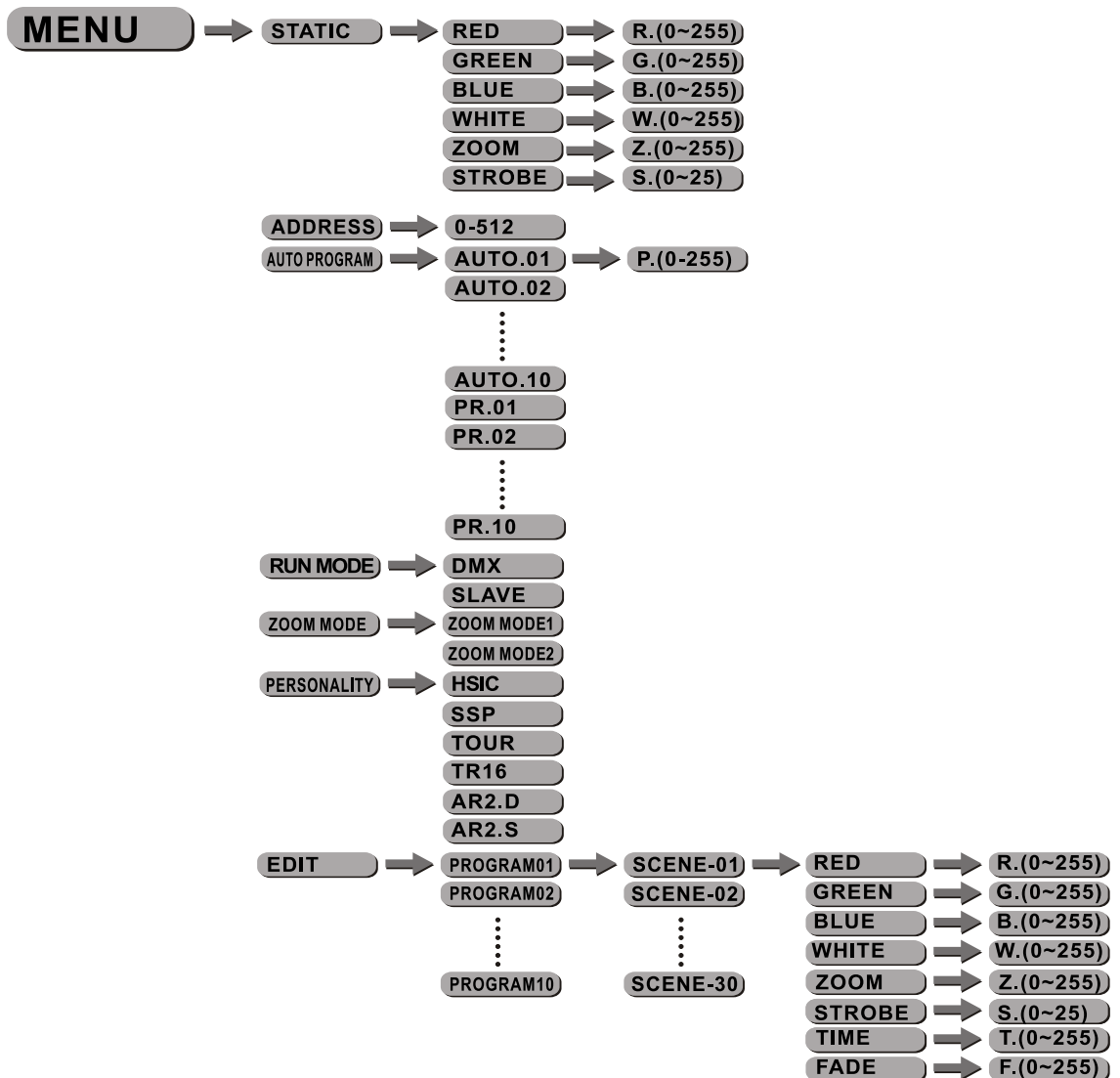

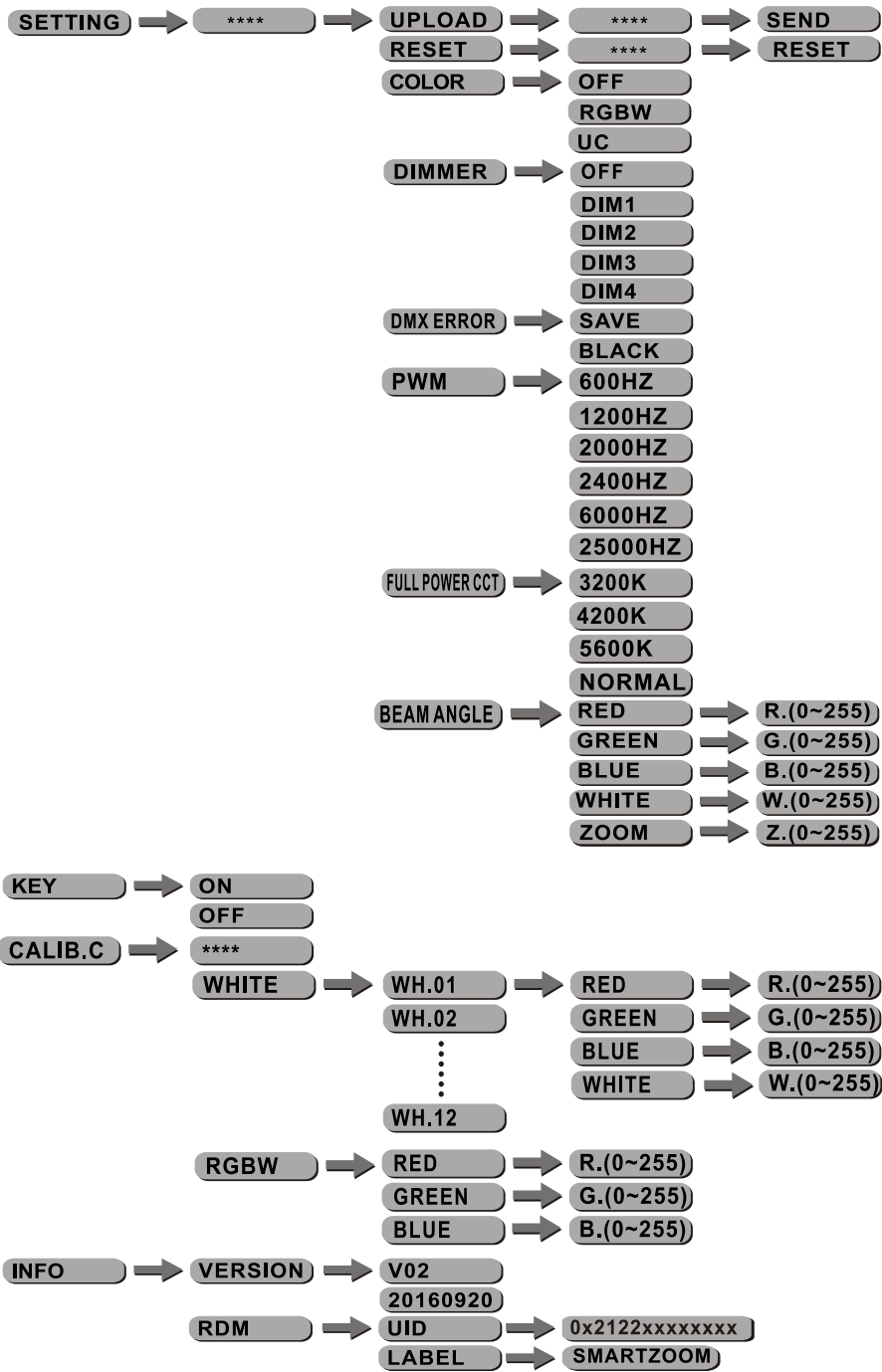

3.3 EDIT STATIC COLOUR

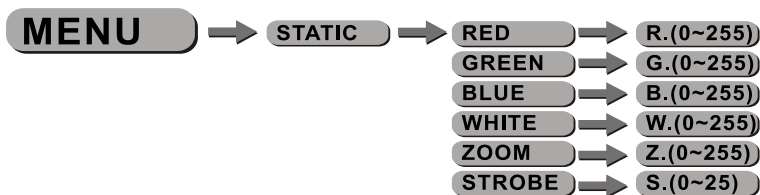

- Combine **【RED】** , **【GREEN】** , **【BLUE】** , **【WHITE】** AND **【ZOOM】** to create an infinite range of colors (0-255)
- Set the value of the **【STROBE】** (0-25Hz)

3.4 DMX512 SETTINGS



- Enter the **【 ADDRESS】** mode to set the DMX ADDRESS.

3.5 ACTIVATING AUTO PROGRAMS

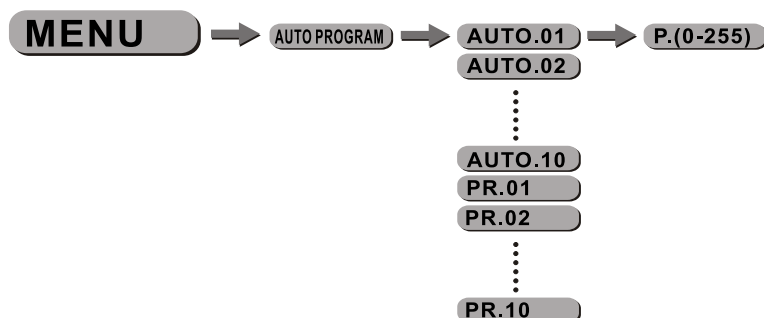

- Select the target **【AUTO PROGRAM】** program and press **【ENTER】** .
- Programs **【AUTO.01】** to **【AUTO.10】** are fully pre-programmed and will not be altered by changes in **【EDIT】** mode.
- Programs **【PR.01】** to **【PR.10】** are fully pre-programmed and can be edited in **【EDIT】** mode.

3.6 RUN MODE



- Enter the **【 RUN MODE】** mode to set working mode.
- **【DMX】** mode is for using the DMX512 controller to control the fixtures.
- **【SLAVE】** mode is for Master -- Slave operation.

3.7 ZOOM MODE



- **【ZOOM MODE 1】** is the default fast zoom speed, work in Ambient Temp. > 0°C
- **【ZOOM MODE 2】** is slow zoom speed, works in Ambient Temp. < 0°C

3.8 PERSONALITY

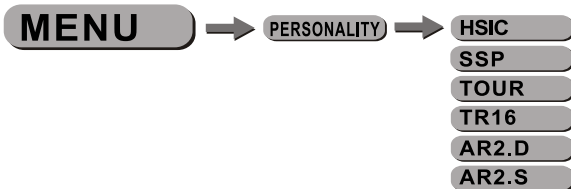

- Enter the **【PERSONALITY】** mode to select DMX mode: **【HSIC】 \ 【SSP】 \ 【TOUR】 \ 【TR16】 \ 【AR2.D】 \ 【AR2.S】 ..**

Introduction for HSIC

- HUE: colorful present(red, orange,yellow, green,cyan, blue, magenta,color changeable)
- HUE FINE: fine dimming when choose a color
- SATURATION: adjust saturation when choose a color
- INTENSITY: adjust intensity for chosen color
- CCT: choose needed color temperature(2700k, 3000k, 3200k, 3500k, 4000k, 4200k, 4500k, 5600k, 6000k, 6500k, 7200k, 8000k)

3.9 EDITING CUSTOM PROGRAMS

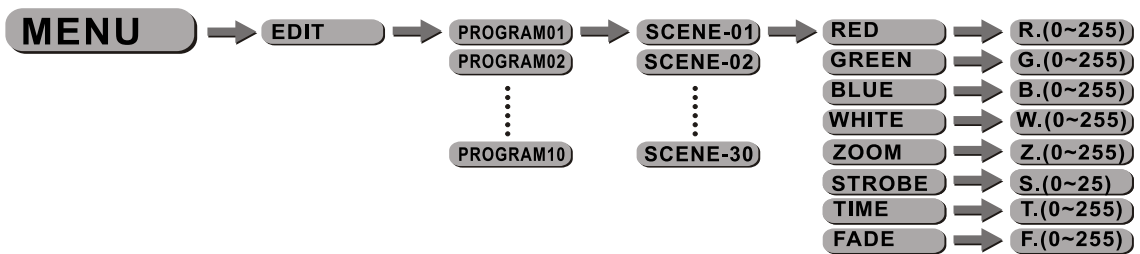

- Enter the **【EDIT】** mode to edit the custom programs **【PROGRAM01】** to **【PROGRAM10】** .
- Each custom program has 30 scenes that can be edited.
- Each step allows the creation of a scene using RED **【RED】** , GREEN **【GREEN】** , BLUE **【BLUE】** , WHITE **【WHITE】** , ZOOM **【ZOOM】** , STROBE **【STROBE】** , TIME **【TIME】** & FADE **【FADE】** .

3.10 SPECIAL SETTINGS

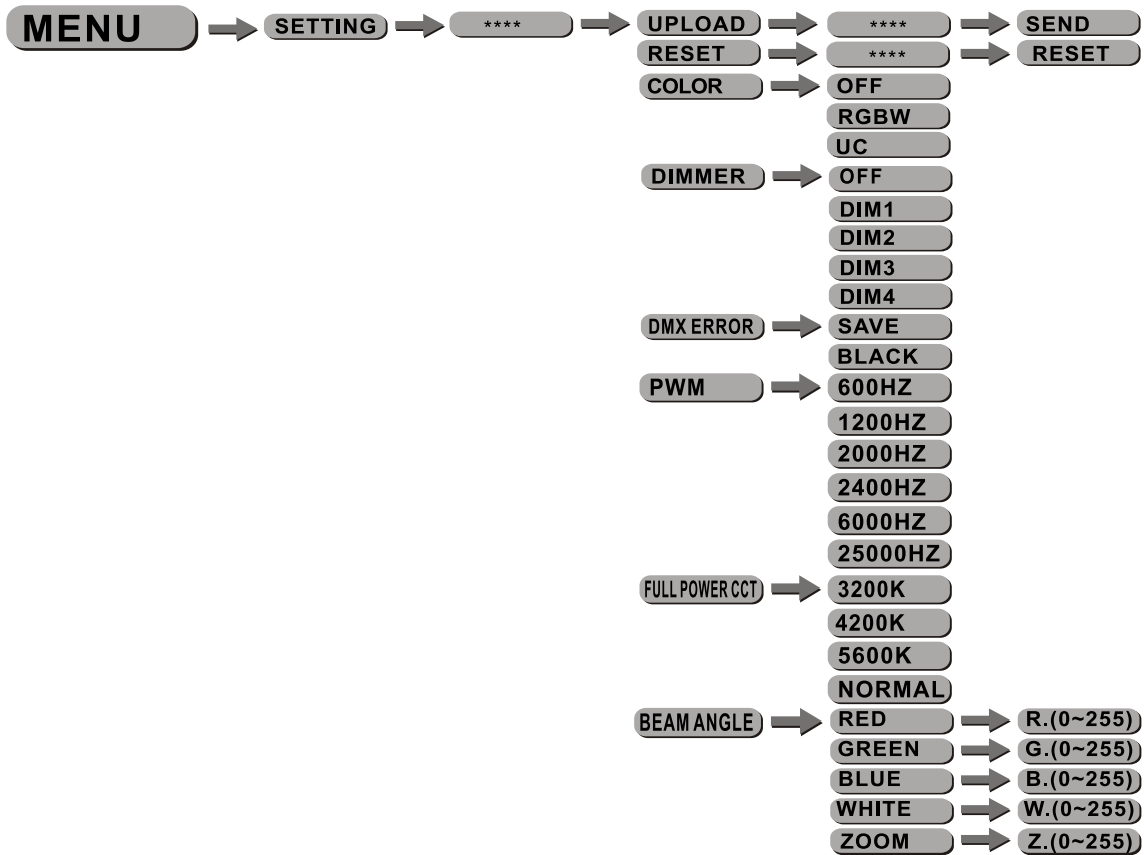

- [SETTING]...this menu allows the user to adjust key operation settings for this fixture.
- Select [UPLOAD] to upload the custom programs from the current MASTER unit to the SLAVE units.
- In order to reset custom modes to default values select [RESET].
Note: [UC][RGBW][CALIB.C] can't reset
- [COLOR] is for activate/unactivate the color calibration functions. When [RGBW] is selected, on RGB = 255,255,255, the color is displayed as calibrated in CALIB.C -- RGBW. When [COLOR] is set [OFF], on RGB = 255,255,255, the RGB values are not adjusted and the output is most powerful. When [UC] is selected, the RGB output are adjusted to a standard preset universal color which balances fixtures from different generations.
Note: [COLOR] work only when choose [NORMAL] at [FULL POWER CCT]
- Select [DIM1], [DIM2], [DIM3] or [DIM4] for different dimming speeds. ([DIM4] is the slowest dimming speed)
- [DMX ERROR] Choose [SAVE] in order to save the last DMX data in case of DMX signal error. Choose [BLACK] in order to blackout in case of DMX signal error.
- <PWM_RATE> is PWM refresh rate bottom, press UP/DOWN to choose <600Hz>, <1200Hz>, <2000Hz>, <4000Hz>, <25000Hz>
Note: with refresh rate increased, gray rate of dimmer will be reduced, (that's means high refresh rate, low gray rate), when it's <4000Hz>, CV3 is invalid, when it's <25000Hz>, CV1 CV2 CV3 are invalid, so please lower PWM rate to increase gray rate in necessary.
- <FULL POWER CCT> is the color temperature choose bottom, press UP/DOWN to choose, under full power, <3200K>, <4200K>, <5600K> can be chosen, when choose <COLOR>, <3200K>, <4200K>, <5600K> are not work, but choose <NORMAL>.
- <BEAM ANGLE> is beam angle choose bottom. When choose it, the fixture runs on full power in factory settings. And the <ZOOM> setting value only works on AR2.S and AR2.D channel mode.

3.11 ACTIVATE THE PASSWORD



- Enter the **【KEY】** mode to select whether the access password is on or off.
- When the fixture is set as PASS **【ON】** , after 30 seconds or turn on the fixture next time, the fixture will need an access password to enter the display menu control.

Note: The factory access password is **【UP】 + 【DOWN】 + 【UP】 + 【DOWN】** , then press **【ENTER】** to confirm the access.

3.12 BALANCE PARAMETERS AND CORRECTION MENU DISPLAY

Press **【MENU】** button to enter the password confirmation, to enter the correct password < UP + DOWN + UP + DOWN >

Key, press the **【MENU】** in, the correct password will enter show submenu

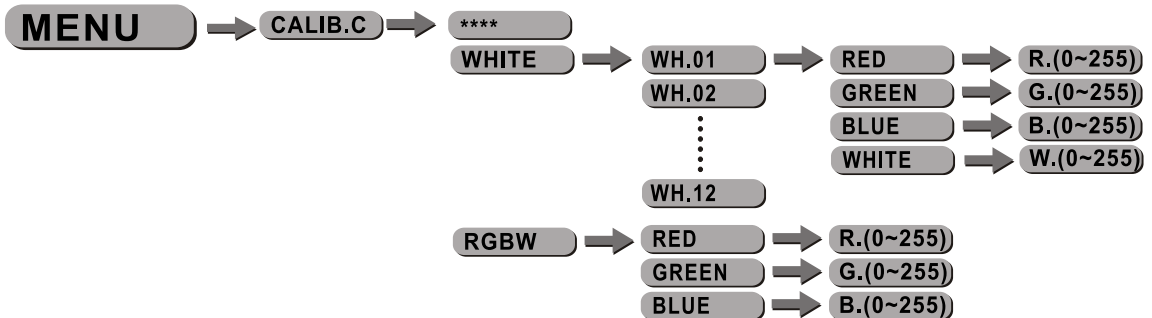

- Enter the **【CALIB.C】** to select white color of different color temperature.
- There are 12 pre-programmed White colors can be edited by using **【RED】** , **【GREEN】** , **【BLUE】** & **【WHITE】** .

- When DMX mode is HSIC, CH5 can play 12 white color
- When DMX mode is TOUR, CH6 can play 12 white color
- When DMX mode is TR16, CH11 can play 12 white color

Note: if CCT data is changed in **【WHITE】** from WT.01 to WT.12, CCT of according channel will be changed also

- Enter the **【RGBW】** to adjust the RGB parameter to make different whites.
- When the new setting is activated, the DMX controller choose RGB = 255,255,255 the white color will be made by the actual RGB values on the **【RGBW】** .

3.13 INFO



- Press **【ENTER】** and go to **【INFO】** ,you can check **【VERSION】** , press **【DOWN】** / **【UP】** to check **【RDM】** , **【LABEL】** , press **【MENU】** and back.

4 USING A DMX512 CONTROLLER

4.1 CHANNEL ASSIGNMENT

- Note: This product have four DMX512 channel configuration: 【HSIC】 , 【SSP】 , 【TOUR】 , 【TR16】 .

HSIC		
CHANNEL	VALUE	FUNCTION
1	0 ⇔ 255	INTENSITY
2	0 ⇔ 255	HUE
3	0 ⇔ 255	HUE FINE
4	0 ⇔ 255	SATURATION
5		CCT
	0 ⇔ 10	NO FUNCTION
	11 ⇔ 30	2700K
	31 ⇔ 50	3000K
	51 ⇔ 70	3200K
	71 ⇔ 90	3500K
	91 ⇔ 110	4000K
	111 ⇔ 130	4200K
	131 ⇔ 150	4500K
	151 ⇔ 170	5600K
	171 ⇔ 190	6000K
	191 ⇔ 210	6500K
	211 ⇔ 230	7200K
	231 ⇔ 255	8000K
6		STROBE
	0 ⇔ 9	NO FUNCTION
	10 ⇔ 99	STROBE FROM (SLOW TO FAST , 0-25Hz)
	100 ⇔ 109	NO FUNCTION
	110 ⇔ 179	LIGHTNING STROBE
	180 ⇔ 189	NO FUNCTION
	190 ⇔ 255	RANDOM SROBE
7	0 ⇔ 255	ZOOM
8	0 ⇔ 200	NO FUNCTION
	201 ⇔ 220	ZOOM RESET
	221 ⇔ 255	NO FUNCTION
9		DIMMER SPEED
	0 ⇔ 9	NO FUNCTION
	10 ⇔ 29	OFF
	30 ⇔ 69	DIM1
	70 ⇔ 129	DIM2
	130 ⇔ 189	DIM3
	190 ⇔ 255	DIM4

SSP

CHANNEL	VALUE	FUNCTION
1	0 ↔ 255	MASTER DIMMER
2	0 ↔ 255	RED
3	0 ↔ 255	GREEN
4	0 ↔ 255	BLUE
5	0 ↔ 255	WHITE
		STROBE
	0 ↔ 9	NO FUNCTION
	10 ↔ 99	STROBE FROM (SLOW TO FAST , 0-25Hz)
	100 ↔ 109	NO FUNCTION
	110 ↔ 179	LIGHTNING STROBE
6	180 ↔ 189	NO FUNCTION
	190 ↔ 255	RANDOM SROBE
7	0 ↔ 255	ZOOM
	0 ↔ 200	NO FUNCTION
8	201 ↔ 220	ZOOM RESET
	221 ↔ 255	NO FUNCTION
		DIMMER SPEED
	0 ↔ 9	NO FUNCTION
	10 ↔ 29	OFF
	30 ↔ 69	DIM1
	70 ↔ 129	DIM2
9	130 ↔ 189	DIM3
	190 ↔ 255	DIM4

TOUR

CHANNEL	VALUE	FUNCTION
1	0 ↔ 255	MASTER DIMMER
2	0 ↔ 255	RED
3	0 ↔ 255	GREEN
4	0 ↔ 255	BLUE
5	0 ↔ 255	WHITE
		COLOR MARCOS
	0 ↔ 10	NO FUNCTION
	11 ↔ 30	RED 100% / GREEN UP / BLUE 0%
	31 ↔ 50	RED DOWN / GREEN 100% / BLUE 0%
	51 ↔ 70	RED 0% / GREEN 100% / BLUE UP
	71 ↔ 90	RED 0% / GREEN DOWN / BLUE 100%
	91 ↔ 110	RED UP / GREEN 0% / BLUE 100%
	111 ↔ 130	RED 100% / GREEN 0% / BLUE DOWN
	131 ↔ 150	RED 100% / GREEN UP / BLUE UP
	151 ↔ 170	RED DOWN / GREEN DOWN / BLUE 100%
6	171 ↔ 195	ALL LEDS AT FULL OUTPUT
	196 ↔ 200	2700K
	201 ↔ 205	3000K
	206 ↔ 210	3200K
	211 ↔ 215	3500K
	216 ↔ 220	4000K
	221 ↔ 225	4200K
	226 ↔ 230	4500K
	231 ↔ 235	5600K
	236 ↔ 240	6000K
	241 ↔ 245	6500K
	246 ↔ 250	7200K
	251 ↔ 255	8000K
		STROBE
	0 ↔ 9	NO FUNCTION
7	10 ↔ 99	STROBE FROM (SLOW TO FAST , 0-25Hz)
	100 ↔ 109	NO FUNCTION
	110 ↔ 179	LIGHTNING STROBE
	180 ↔ 189	NO FUNCTION
	190 ↔ 255	RANDOM SROBE

CHANNEL	VALUE	FUNCTION
		AUTO
8	0 ⇔ 40	NO FUNCTION
	41 ⇔ 50	AUTO1
	51 ⇔ 60	AUTO2
	61 ⇔ 70	AUTO3
	71 ⇔ 80	AUTO4
	81 ⇔ 90	AUTO5
	91 ⇔ 100	AUTO6
	101 ⇔ 110	AUTO7
	111 ⇔ 120	AUTO8
	121 ⇔ 130	AUTO9
	131 ⇔ 140	AUTO10
	141 ⇔ 150	PROGRAM1
	151 ⇔ 160	PROGRAM2
	161 ⇔ 170	PROGRAM3
	171 ⇔ 180	PROGRAM4
	181 ⇔ 190	PROGRAM5
	191 ⇔ 200	PROGRAM6
	201 ⇔ 210	PROGRAM7
	211 ⇔ 220	PROGRAM8
	221 ⇔ 230	PROGRAM9
231 ⇔ 255	PROGRAM10	
9	0 ⇔ 255	AUTO SPEED ADJUSTMENT
10	0 ⇔ 255	ZOOM
11	0 ⇔ 200	NO FUNCTION
	201 ⇔ 220	ZOOM RESET
	221 ⇔ 255	NO FUNCTION
12		DIMMER SPEED
	0 ⇔ 9	NO FUNCTION
	10 ⇔ 29	OFF
	30 ⇔ 69	DIM1
	70 ⇔ 129	DIM2
	130 ⇔ 189	DIM3
	190 ⇔ 255	DIM4

TR16

CHANNEL	VALUE	FUNCTION
1	0 ⇔ 255	MASTER DIMMER
2	0 ⇔ 255	MASTER DIMMER FINE
3	0 ⇔ 255	RED
4	0 ⇔ 255	RED FINE
5	0 ⇔ 255	GREEN
6	0 ⇔ 255	GREEN FINE
7	0 ⇔ 255	BLUE
8	0 ⇔ 255	BLUE FINE
9	0 ⇔ 255	WHITE
10	0 ⇔ 255	WHITE FINE
		COLOR MARCOS
	0 ⇔ 10	NO FUNCTION
	11 ⇔ 30	RED 100% / GREEN UP / BLUE 0%
	31 ⇔ 50	RED DOWN / GREEN 100% / BLUE 0%
	51 ⇔ 70	RED 0% / GREEN 100% / BLUE UP
	71 ⇔ 90	RED 0% / GREEN DOWN / BLUE 100%
	91 ⇔ 110	RED UP / GREEN 0% / BLUE 100%
	111 ⇔ 130	RED 100% / GREEN 0% / BLUE DOWN
	131 ⇔ 150	RED 100% / GREEN UP / BLUE UP
	151 ⇔ 170	RED DOWN / GREEN DOWN / BLUE 100%
11	171 ⇔ 195	ALL LEDS AT FULL OUTPUT
	196 ⇔ 200	2700K
	201 ⇔ 205	3000K
	206 ⇔ 210	3200K
	211 ⇔ 215	3500K
	216 ⇔ 220	4000K
	221 ⇔ 225	4200K
	226 ⇔ 230	4500K
	231 ⇔ 235	5600K
	236 ⇔ 240	6000K
	241 ⇔ 245	6500K
	246 ⇔ 250	7200K
	251 ⇔ 255	8000K
		STROBE
	0 ⇔ 9	NO FUNCTION
12	10 ⇔ 99	STROBE FROM (SLOW TO FAST , 0-25Hz)
	100 ⇔ 109	NO FUNCTION
	110 ⇔ 179	LIGHTNING STROBE
	180 ⇔ 189	NO FUNCTION
	190 ⇔ 255	RANDOM SROBE

CHANNEL	VALUE	FUNCTION
13		AUTO
	0 ↔ 40	NO FUNCTION
	41 ↔ 50	AUTO1
	51 ↔ 60	AUTO2
	61 ↔ 70	AUTO3
	71 ↔ 80	AUTO4
	81 ↔ 90	AUTO5
	91 ↔ 100	AUTO6
	101 ↔ 110	AUTO7
	111 ↔ 120	AUTO8
	121 ↔ 130	AUTO9
	131 ↔ 140	AUTO10
	141 ↔ 150	PROGRAM1
	151 ↔ 160	PROGRAM2
	161 ↔ 170	PROGRAM3
	171 ↔ 180	PROGRAM4
	181 ↔ 190	PROGRAM5
	191 ↔ 200	PROGRAM6
	201 ↔ 210	PROGRAM7
	211 ↔ 220	PROGRAM8
221 ↔ 230	PROGRAM9	
231 ↔ 255	PROGRAM10	
14	0 ↔ 255	AUTO SPEED ADJUSTMENT
15	0 ↔ 255	ZOOM
16	0 ↔ 200	NO FUNCTION
	201 ↔ 220	ZOOM RESET
	221 ↔ 255	NO FUNCTION
17		DIMMER SPEED
	0 ↔ 9	NO FUNCTION
	10 ↔ 29	OFF
	30 ↔ 69	DIM1
	70 ↔ 129	DIM2
	130 ↔ 189	DIM3
	190 ↔ 255	DIM4

AR2.S

CHANNEL	VALUE	FUNCTION
1	0 ↔ 255	MASTER DIMMER
2	0 ↔ 255	RED
3	0 ↔ 255	GREEN
4	0 ↔ 255	BLUE
5	0 ↔ 255	WHITE
6	0 ↔ 255	STROBE

AR2.D

CHANNEL	VALUE	FUNCTION
1	0 ↔ 255	MASTER DIMMER
2	0 ↔ 255	RED
3	0 ↔ 255	GREEN
4	0 ↔ 255	BLUE
5	0 ↔ 255	WHITE

Important note:

In **AR2.S** & **AR2.D** channel modes there is no zoom channel available. However you can set a fixed beam angle manually so you can use the BT-SMARTZOOM also with these simple channel modes.

To set the fixed beam angle:

- * In de setup menu select SETTING > BEAM ANGLE
- * Set the beam angle manually from 000 to 255.

From now on the beam angle setting will be used for AR2.S and AR2.D While using another channel mode, the beam angle settings will not be used.



MAILING LIST

EN: Subscribe today to our mailing list for the latest product news!

FR: Inscrivez-vous à notre liste de distribution si vous souhaitez suivre l'actualité de nos produits!

NL: Abonneer je vandaag nog op onze mailinglijst en ontvang ons laatste product nieuws!

DE: Abonnieren Sie unseren Newsletter und erhalten Sie aktuelle Produktinformationen!

ES: Suscribete hoy a nuestra lista de correo para recibir las últimas noticias!

WWW.BRITEQ-LIGHTING.COM

Copyright © 2016 by BEGLEC NV

t Hofveld 2C ~ B1702 Groot-Bijgaarden ~ Belgium

Reproduction or publication of the content in any manner, without express permission of the publisher, is prohibited.