



V6 INTELLIGENT CHAIN HOIST USER MANUAL

Table of contents

1 GENERAL INTRODUCTION.....	5
1.1 Foreword: About this Manual	5
1.2 Symbols Used in this Manual.....	5
1.3 Safety Alert Symbols and Signal Words.....	5
1.4 Questions and Comments	6
1.5 Exclusion of Warranty	6
1.6 Manual Use.....	7
1.7 Environmental Information.....	7
1.7.1 Lifecycle Environmental Impacts.....	7
1.7.2 Energy Consumption.....	7
1.8 Terminology	8
2 SAFETY FIRST!	9
2.1 Personal Protective Equipment (PPE).....	9
2.1.1 Fall Protection	10
2.2 Fire Safety.....	10
2.3 Main Isolation Switch.....	11
2.4 Emergency stop	11
2.5 Owner's Responsibilities	12
2.5.1 General Safety Issues.....	12
2.5.2 Chain Hoist Machinery Safe Working Period (SWP)	14
2.5.3 How to Assess the Hoisting Machinery Safe Working Period	14
2.6 Intended use of the product.....	15
2.6.1 Duty Group.....	15
2.7 Operating Environment	17
2.8 Safety During Installation	17
2.9 Safety during Usage	19
2.10 Safety during maintenance.....	20
2.10.1 Lockout-Tagout Procedure.....	22
2.11 Sound Intensity Level.....	23
3 IDENTIFICATION.....	24
3.1 Hoist identification data	24
3.2 Manufacturer.....	25
3.3 Standards and Directives.....	25

4 CONSTRUCTION	26
4.1 Identifying the key parts of the hoist.....	26
4.2 Main Functions	27
4.2.1 Hoisting Function	27
4.2.2 Safety Functions	28
4.3 Signs	28
4.3.1 Safety Signs.....	28
5 INSTALLATION	29
5.1 Installation preparations	29
5.1.1 Lifting the hoist	30
5.2 Electrical connections.....	32
6 COMMISSIONING	34
6.1 Commissioning preparations.....	34
6.2 Checks before first run	35
6.3 Test Run Without Load	36
6.4 Test run with test load	38
6.5 After test runs	39
7 INSTRUCTIONS FOR THE OPERATOR.....	40
7.1 Operator’s Responsibilities	40
7.2 Checks to Be Done Before Every Working Shift	42
7.2.1 Checks to be performed by the operator.....	42
7.2.2 Operational Checks with the Emergency Stop Button Pushed Down	43
7.2.3 Operational Checks with Controller Enabled.....	43
7.3 Movements.....	45
7.3.1 Motor Control Methods	46
7.3.2 Lifting and Lowering Motions	46
7.4 Load Handling.....	47
7.5 Load Control	53
7.6 Safety Procedure After Using the Hoist.....	54
7.7 Hand Signals and Other Methods of Communication	55
8 MAINTENANCE.....	56
8.1 Why You Must Care About Maintenance	56
8.2 Service Personnel.....	57
8.3 Inspections	57

8.3.1 Daily Inspections.....	57
8.3.2 Monthly inspections.....	58
8.3.3 Quarterly inspections.....	58
8.3.4 Annual inspections.....	58
8.4 Lubrication.....	64
8.4.1 General lubrication instructions	64
8.5 Lubrication charts.....	66
8.6 Approaching Theoretical Calculated Lifetime	67
8.6.1 Special Assessment	67
8.6.2 General Overhaul.....	67
8.7 Returning the Product to Use after a Long Period Out of Service.....	68
8.8 Frame.....	69
8.9 Motor	70
9 DISMANTLING	71
9.1 Dismantling the Product.....	71
9.2 Disposal of Waste Material.....	71
10 TECHNICAL DATA.....	73
10.1 Technical Features	73
10.2 Tightening torques	73
APPENDIX: INSPECTING CHAIN WEAR.....	74
APPENDIX: INSPECTING THE HOOK OPENING.....	76
APPENDIX: TROUBLESHOOTING (3 PHASES)	77
APPENDIX: TRANSPORTING AND STORING THE PRODUCT	78
APPENDIX: SAFE WORKING PERIOD (SWP) CALCULATION	79
ANNEX, ANSI HAND SIGNALS.....	82

1 GENERAL INTRODUCTION

1.1 Foreword: About this Manual

This manual offers guidance to enable safe and efficient operation of the equipment.



Taking the time to read this manual will help you to prevent damage to the equipment, and, most importantly, personnel situated close to it. The equipment is designed to be safe when used correctly. However, there are many potential hazards associated with incorrect operation and these can be avoided when you know how to recognize and anticipate them.

This manual will also make you aware of your responsibilities with respect to the equipment and help you to ensure that it is kept in a safe operating condition throughout its lifetime.

This manual is not intended as a substitute for proper training but provides recommendations and methods for safe and efficient operation and maintenance. The equipment's owner must ensure that operators are properly trained prior to operation and, at all times, comply with all of the applicable and prevailing safety and other standards, rules and regulations.



1.2 Symbols Used in this Manual



Readers should familiarize themselves with the following symbols which are used in this manual.

	Indicates that the product is slowing down or is moving at its slowest speed.
	Indicates that the product is accelerating or moving at its highest speed.
	NOTE: Indicates items which require special attention by the reader. There is no obvious risk of injury associated with notes.

1.3 Safety Alert Symbols and Signal Words

The following symbols are used in this manual to indicate potential safety hazards.

	Obey all safety messages that follow this symbol to avoid possible injury or death.
 CAUTION	Indicates a potentially hazardous situation, which if not avoided, MAY result in minor or moderate injury. It may also be used to alert against unsafe practices.

 WARNING	Indicates a potentially hazardous situation, which if not avoided, COULD result in death or serious injury.
 DANGER	INDICATES AN IMMINENTLY HAZARDOUS SITUATION WHICH, IF NOT AVOIDED, WILL RESULT IN DEATH OR SERIOUS INJURY.
NOTICE	Addresses situations not related to personal injury, such as likely or possible damage to equipment.
Shall	Indicates that a rule is mandatory and must be followed.
Should	Indicates that a rule is a recommendation, the advisability of which depends on the facts in each situation.

1.4 Questions and Comments

Any questions or comments relating to the content of this manual and/or the operation, maintenance and/or service of manufacturer products should be directed to:
www.modehoist.com

1.5 Exclusion of Warranty

All technical information and data in the workbook and tips are in line with the latest technical level before publication, and draw lessons from the experience so far we faithfully and instructions.

Involved in this manual to the continued development of the electric hoist, we reserve the right to revise the technology, and not from the data in this manual, illustrations and specifications of the other requirements.

Relevant specification, and the results show that, not necessarily, in full compliance with the scope of supply or spare parts supply illustrations and diagrams are not drawn in proportion.

Everything will be subject to orders attached data.

Due to operational errors, ignoring the instructions or maintain undeserved and cause damage to the operation of the fault, we shall not be responsible for.

We hereby made clear that only allows the use of animal husbandry, the company determined by the original spare parts and accessories. This applies to the components of other manufacturers.

For security reasons, that shall not be installed and used without the permission of spare parts or accessories, also may not be modified without authorization. Or animal husbandry, company shall not bear the resulting consequences.

For our cause accidental error or omission, by MODE according to the main scope of the guarantee obligations in the contract (not including other requirements) guarantee obligations. The names for the compensation according to law and extended out requirements, shall not consider.

1.6 Manual Use

Every person exposed to the manufacturer's equipment must, prior to OPERATING, SERVICING AND/OR MAINTAINING SUCH PRODUCTS, read and understand the contents of this manual and strictly adhere AND CONFORM THEIR CONDUCT WITH AND TO THE INFORMATION, RECOMMENDATIONS AND warnings provided herein.



Note: Keep these instructions in a safe, accessible location for future reference by personnel operating the equipment or exposed to the equipment's operation.



Read and understand the contents of this manual prior to operating, servicing, and or/maintaining the equipment. Failure to do so can result in serious injury or death.

1.7 Environmental Information

Environmental aspects have been taken into account in designing and manufacturing this product. To prevent environmental risks during use, please follow instructions for safe lubricant handling and disposal of waste material. Proper use and maintenance improves environmental performance of this product.

1.7.1 Lifecycle Environmental Impacts

The lifecycle stages are:

- production of materials,
- components and energy,
- transportation to factory,
- equipment manufacturing and assembly,
- transportation to customer,
- assembly at site,
- use phase including maintenance and modernization,
- end of life dismantling and recycling of the materials.

1.7.2 Energy Consumption

Energy consumption during the use phase is the biggest environmental. Electricity is needed for lifting and traveling motors as well as lighting, heating, cooling and other optional electrical components as part of the hoist. Lighting may account for a significant part of total electricity used.

1.8 Terminology

The following terms and definitions are used in this manual:

ANSI	American National Standards Institute
ISO	International Organization for Standardization
Authorized personnel	Persons who are authorized by the owner and who have the necessary training to carry out operation or service actions
Experienced service person authorized by the manufacturer	A person with service experience who is authorized by the manufacturer to perform service actions.
CE marking	The CE-marking indicates that the product complies with the appropriate EC directives.
Check	A visual and functional assessment (not a test) of the product without dismantling.
Emergency brake	A brake that can be applied by the operator, or automatically upon loss of power.
Electric panel	Power to the motors is controlled through the electric panel.
Operator	Person operating the product for the purpose of handling loads.
Inching	Making very small movements by repeatedly and momentarily pressing the direction control.
Main isolation switch	The main isolation switch is the power switch which the operator should normally use to turn off power.
Chain hoist	Drive mechanism for lifting and lowering the load.
Inspection	Looking for defects and checking the operation of the controls, limiting and inspecting devices without loading the product. This is much more than a check but does not normally require any part of the product to be dismantled other than for removal or opening of covers or housings.
Power supply	Power is supplied to the motors via the power supply.
Controller	The pendant or other type of controller is used by the operator to give commands to the product.
Qualified personnel	Workers with necessary qualifications based on theoretical and practical knowledge of hoists. A qualified person must be in a position to assess the safety of the installation in conjunction with the application. Persons with the authority to undertake certain product maintenance work include the manufacturers' service engineers and trained fitters with a corresponding certification.
Maximum capacity	Load that the product is designed to lift for a given operating condition (e.g. configuration, position of the load).
Trolley (hoisting unit)	The trolley (hoisting unit) moves along the girder.
Sling	A sling is used to attach the hook to the load when the load cannot be lifted directly by the hook.

2 SAFETY FIRST!

Safety requirements must be understood and followed.

2.1 Personal Protective Equipment (PPE)



Note: This chapter proposes personal protective equipment to ensure operator's full safety. Local regulations and requirements of the working environment shall be followed.

For safety, operator or others in close proximity to the product may be required to wear Personal Protective Equipment (PPE). Various types of PPE are available and must be selected according to the requirements of the working environment. Some examples of different types of PPE are:

Typical PPE

- A. Hard hat
- B. Hearing protection
- C. Gloves
- D. Safety shoes
- E. Safety goggles
- F. Face mask
- G. Flashlight for use in case of power failure
- H. Overalls

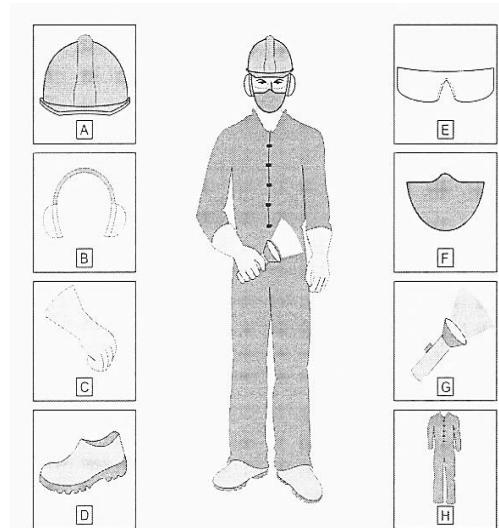

Appropriate clothing must be selected for each task. For example:

- Fire-resistant clothing must be worn when welding, flame cutting or using an angle grinder.
- Tear-resistant clothing must resist damage from sharp edges in the steel structure.
- Anti-static clothing must be worn when working on electrical circuits so that components do not get damaged by a discharge of static electricity.
- When working with lubricants, clothing must prevent direct skin contact with the lubricant.
- Clothing should be chosen with consideration to the temperature at the working site.

2.1.1 Fall Protection



While personnel are performing inspection or maintenance work at heights, they must follow fall protection procedures as required by local regulations. Fall prevention practices and fall protection equipment aim to protect personnel working on or around the equipment from exposure to falls.

If the equipment does not have a service platform or handrail, personnel must use a properly fitted safety harness that is attached to the dedicated fixing points on the building or equipment in order to prevent falls.

If the product does not have dedicated fixing points for fall protection, it is the owner's responsibility to make sure that there are suitable fixing points in the building structure.

If ladders must be used, personnel must practice setting and securing the ladders before using them for actual work.

A typical fall protection program may include:

- Documented and established site policies and procedures.
- Conducting site assessments for fall hazards.
- Selection of the proper fall protection system and equipment.
- Training on fall protection procedures and the proper use of fall protection systems.
- Inspection and proper maintenance of fall protection equipment.
- Measures to prevent falling objects.
- Rescue Plans.

If necessary, contact your supplier or service organization for assistance with designing your fall protection program.

2.2 Fire Safety

In the event of a fire, only attempt to fight it if you can do so without putting yourself in danger. Turn the power off if it is possible to do so. Evacuate the area. Notify other people about the potential danger, and call for help.



WARNING

Never use a powder type fire extinguisher on high voltage.

2.3 Main Isolation Switch

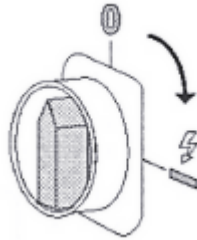

The product can only be driven when power is turned on. The owner must identify and document the location and function of the main isolation switch and must communicate this information to all operators.

 CAUTION	Owner/Operator shall be aware of main isolation switch functionality. Even though one switch is turned off, there may still be voltage present in some parts of the product. This may result in exposure to electric shocks.
--	---

	The operator shall not operate the product unless he or she knows the location of the main isolation switch.
---	---

 CAUTION	Avoid turning off the main isolation switch during load movement. Sudden loss of power may cause the load to swing and cause serious damage to the product, personnel or load.
--	---

When the main isolation switch is turned on after being placed in the off position, the set-up procedure must be followed before the product can be used.

2.4 Emergency stop

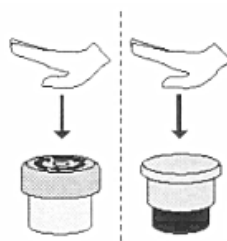

In the event of an equipment malfunction or other emergency situation, all motions can be stopped immediately by pressing the red emergency stop button located on the controller. In normal operation, the emergency stop button should not be used instead of making proper use of the direction controls. Routinely using the emergency stop button increases wear on the product and can cause the load to swing.

NOTICE	Only use the emergency stop button to stop movement in the event of a product malfunction or other emergency situation. Using the emergency stop button can cause the load to swing unexpectedly.
---------------	--





	The operator shall not operate the product unless he or she knows the location of the emergency stop button.
---	---

2.5 Owner's Responsibilities

2.5.1 General Safety Issues

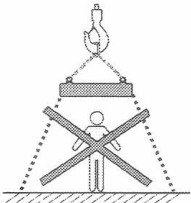

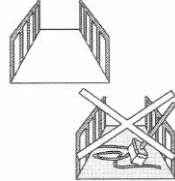
 CAUTION	No modifications or additions to the equipment structures or performance values are permitted unless they are first discussed with and approved by the manufacturer or manufacturer's representative of the equipment.
--	---

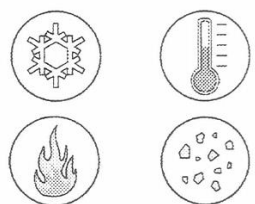
NOTICE	Modifying the equipment without the manufacturer or manufacturer's representative approval can invalidate the guarantee. Furthermore, the manufacturer does not accept responsibility for accidents which happen as a consequence of unauthorized modifications.
---------------	---

1	Maintain safe conditions under the load Owners SHALL ensure that the correct type of chain hoist is selected according to the type of use and hazard arising from that. Owners SHALL make it clear to all aspects (including operating personnel, maintenance personnel and visitors express), anyone have any reason to stand under the load, at any time must abide by the rules.	
2	Maintain the lighting Owners SHALL ensure that there is adequate lighting, in good working order, at the operating site so that the equipment can be operated safely and efficiently at all times.	
3	Maintain walkways and service platforms Owners SHALL ensure that there are adequate walkways and service platforms on the equipment and/or adequate equipment at the operating site for servicing and inspecting the equipment. Walkways and service platforms must be kept in a safe condition and free from obstructions.	
4	Maintain operating and safety requirements Owners SHALL ensure that the equipment meets the applicable (local and global) safety and operating requirements.	
5	Maintenance Owners SHALL ensure that maintenance is carried out at the recommended intervals as determined by the manufacturer.	
6	Maintain the operating conditions Owners SHALL ensure that conditions at the equipment operating site correspond to the operating conditions for which the equipment is designed. For example, factors which affect the operating conditions include indoor/outdoor use, temperature, weather, dust, humidity, hazardous materials and fire risks.	

**WARNING**

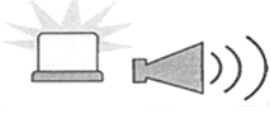
Do not allow the equipment to be used unless it is in proper condition. In case of doubt, contact a service agent authorized by the manufacturer or manufacturer's representative! The use of defective equipment can result in serious damage, injury or death.

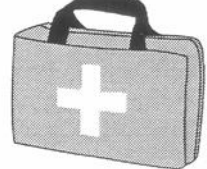
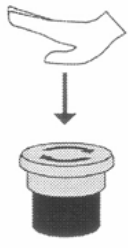
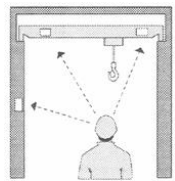
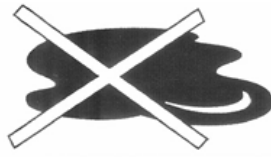
7	<p>Keep the product in a safe condition</p> <p>Owners SHALL ensure that the equipment is kept in a safe condition. For example, all warning devices must be kept in good working order.</p>	
8	<p>Fire safety</p> <p>Owners SHALL ensure that personnel are prepared in case of fire and that the correct fire-fighting equipment is available and maintained.</p>	
9	<p>First Aid</p> <p>Owners SHALL ensure that, in accordance with local regulations, personnel are prepared in case of accidents and that a suitable first-aid kit is available and maintained.</p>	
10	<p>Emergency Stop devices</p> <p>Owners SHALL ensure that they, and the operators, know the locations of emergency stop devices so that they can be activated in emergency situations. Emergency stop devices should never be used as a substitute for making proper use of the direction controls. Routinely using the emergency stop button increases wear on the product components and can cause the load to swing.</p>	
11	<p>Ensure that signs are maintained in good condition</p> <p>Owners SHALL ensure that signs and warnings are present on the equipment and are in good condition.</p>	
12	<p>Keep the working site clean</p> <p>The working site should be kept free of clutter and dirt. Oil spills must be cleaned up immediately to reduce the risk of slipping.</p>	

2.5.2 Chain Hoist Machinery Safe Working Period (SWP)

Based on how the hoisting machinery will be used and on the actual hoisting machinery hardware supplied, the manufacturer will agree the anticipated hoisting machinery lifetime or safe working period(SWP) with the customer at the time of purchase.

The total lifetime of hoisting machinery consists of one or more Safe Working Period (SWP) where each SWP typically lasts around ten years when the equipment is used in accordance with the designed usage. It is possible for different hoisting machineries on the same crane, for example main and auxiliary, to have a different SWP. The SWP is the period in which, provided the equipment has been used and maintained in line with the original expectations, the equipment can be safely operated.

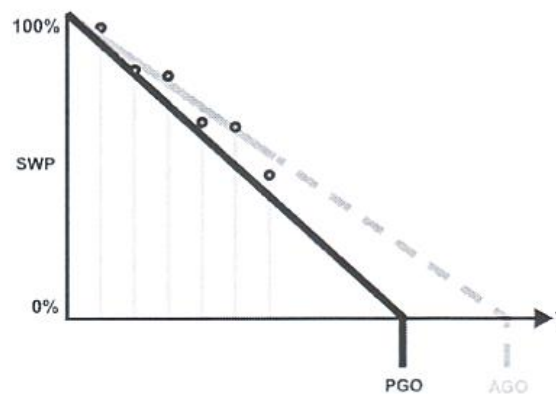

SWP = Safe Working Period
 PGO = Predicted General Overhaul
 AGO = Actual General Overhaul
 T = Time

In practice the lifetime of the equipment can vary due to changes in the environment and usage of the equipment. For safety, in accordance with the S012482-1 standard, it is important for authorized service personnel to periodically check the equipment duty group and operating conditions regularly for any changes, then to revise the remaining SWP% upwards or downwards accordingly. This action ensures that the equipment is kept operating for as long as it is safely possible before a General Overhaul must be conducted.

2.5.3 How to Assess the Hoisting Machinery Safe Working Period

The hoist service organization assesses the hoisting machinery Safe Working Period but this table briefly describes how it is done.

Product	Method
Product equipped with condition monitoring unit	The SWP value can be read from the SWP-data counter display of the condition monitoring unit. Refer to the more detailed instructions provided in the condition monitoring unit operating instructions.
Product equipped with hour counter and log book	The remaining SWP% must be calculated in accordance with the S012482-1 standard, using the formula presented in the "APPENDIX: Safe working period(SWP) Calculation".
Product with log book	
Product without log book	

2.6 Intended use of the product

Electric chain hoists are available for different purposes with various fittings and safety features. It is very important to select correct type of electric chain hoist based on the hazards arising from the type and conditions of use.

This product is designed for use in event industry. The electric chain hoists used in event industry can be divided into three classes:

- D8 chain hoist can be used to lift loads during set-up.
- D8 Plus chain hoist can be used to lift loads during set-up and with hold loads at rest above people.
- C1 chain hoist (scenery hoist) can be used to hold and move loads above people.

Assure that the class of the hoist meets the requirements of the use.

 DANGER	DO NOT ALLOW THE EQUIPMENT TO BE USED FOR LIFTING PERSONNEL UNLESS THE MANUFACTURER OR MANUFACTURER'S REPRESENTATIVE HAS DECLARED IN WRITING THAT IT MAY BE USED FOR THIS PURPOSE.
---	---

 DANGER	DO NOT USE THE CHAIN HOIST FOR HOLDING OR MOVING LOADS ABOVE PEOPLE UNLESS IT IS DESIGNED FOR THAT PURPOSE.
---	--

Modifying the equipment without the permission of the manufacturer or manufacturer's representative can be dangerous and can invalidate the equipment guarantee. Any fundamental modifications to the equipment must be authorized in writing by the manufacturer. Examples of such modifications include:

- Welding or otherwise attaching new items to the product.
- Attaching devices for special material handling such as turning the load.
- Alterations to load-bearing components.
- Alterations to drives and speeds.
- Replacement of major items such as trolleys.

 CAUTION	No modifications or additions to the equipment structures or performance values are permitted unless they are first discussed with, and approved by, the supplier of the equipment.
--	--

 CAUTION	Never use the hoist as an earth reference for welding.
--	---

NOTICE	Modifying the equipment without the manufacturer or manufacturer's representative approval can invalidate the guarantee. Furthermore, the manufacturer does not accept responsibility for accidents which happen as a consequence of unauthorized modifications.
---------------	---

2.6.1 Duty Group

When the product is designed and purchased, the predicted lifetime of the product is agreed, based on the expected use of the product. This expected use is known as the duty group. Hoisting machinery which is used continuously to lift heavy loads is clearly in a very different duty group to a product of the same size which is used occasionally just to lift light loads. While the product is used in accordance with the designed duty group, the expected lifetime should be reached.

It is the owner's responsibility to ensure that the product is used according to the duty group that it has been designed for. By doing so, the product should reach the original predicted lifetime.

 DANGER	DO NOT ALLOW THE PRODUCT TO BE USED OUTSIDE THE LIMITS OF THE SPECIFIED DUTY GROUP. DOING SO RAISES THE RISK OF MECHANICAL FAILURE AND CAN SHORTEN THE PRODUCT'S LIFETIME
--	--

The duty group is based on many factors including the hardware, the predicted lifetime, the number of shifts and lifts, the distances traveled, the ratio of heavy to light items lifted and the environmental conditions the product is used in. Notice that, if you moved from single-shift working to three-shift working, you would need to reduce the loads or distances lifted and/or traveled in order to remain within the requirements of the duty group.

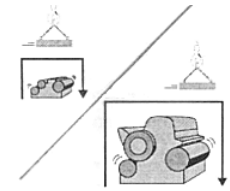
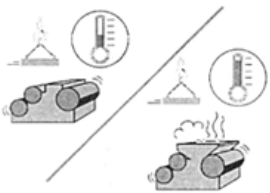
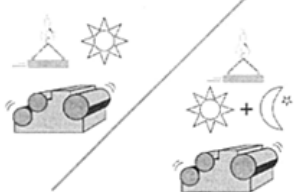
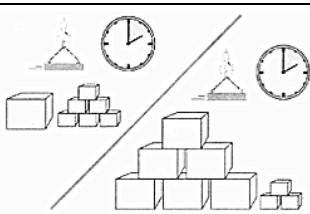
Parameter	Variables	Light use and heavy use
Lifting height and working distances	Actual hoisting time and the average distances being traveled by the trolley and lifting devices.	
Operating environment	The product is designed to work within specific parameters of temperature, humidity and cleanliness.	
Product process	The number of shifts.	
	The number of work cycles per hour and the average lifted loads.	

Authorized service personnel must periodically check whether the product is being used according to the duty group. Owners and operators should recognize that any changes to product usage could, if left unchecked, raise overall maintenance costs and considerably reduce the safe operating lifetime of the product. Changes to any of the parameters and variables can require the duty group to be revised.

If there will be significant permanent changes in the product usage, authorized service personnel must revise the duty group and SWP as necessary. Changes to hardware or servicing frequency may be required.

2.7 Operating Environment

 DANGER	USING THE EQUIPMENT IN AN ENVIRONMENT FOR WHICH IT IS NOT DESIGNED CAN BE DANGEROUS. IT WILL ALSO REDUCE THE EQUIPMENT'S LIFETIME AND INCREASE THE MAINTENANCE REQUIREMENTS.
--	---

If the operating environment deviates from the environment specified when the product was ordered, contact the manufacturer. Solutions are available to enable the product to work in a wide range of operating environments. If the product for general use would be used in exceptional ambient conditions or for handling dangerous substances, consult the manufacturer or manufacturer's representative. Notice, for example, that molten metal is considered a dangerous substance. Examples of exceptional ambient conditions include windy areas, earthquake zones and corrosive atmospheres.

The product designed for general use may be used in normal industrial environments which fulfill the following conditions.

- Indoor products must be situated indoors, protected from outdoor weather conditions.
- Ambient temperature is specified in the order confirmation. Typically it is between -20°C (-4 °F) and +40°C (104 °F) or +50°C (122 °F).
- Air quality meets the requirements of the EN standard 14611-1 1999.
- The product is not exposed to any corrosive chemicals or an explosive atmosphere.
- The product is not located in an area prone to earthquakes.
- The product is less than 1000 m (3280 feet) above sea level.
- Relative air humidity must not exceed 90%.



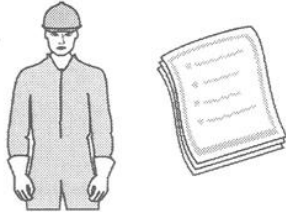
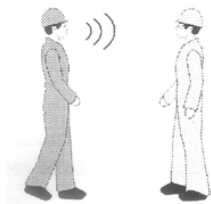

Note: There can be extra optional features in your equipment to allow operation in special environments such as outdoors. In case of doubt please contact your manufacturer or manufacturer's representative.

2.8 Safety During Installation

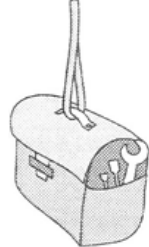
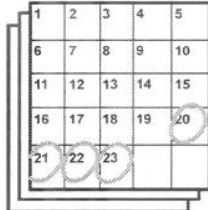
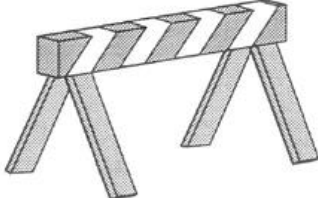
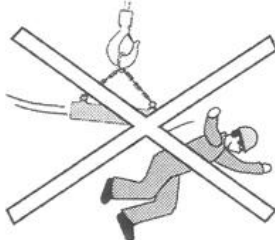
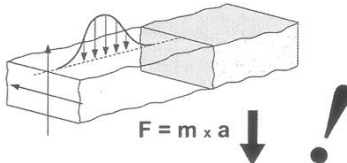
1	Ensure the competence of installation personnel Owners SHALL ensure that installation personnel are professionally competent, professionally qualified and are provided with adequate instructions for carrying out the work.	
2	Ensure proper commissioning and handover Owners SHALL ensure that the test loading, test drive and commissioning inspection have been properly executed and that the handover log has been properly completed. Owners SHALL ensure that components, electrical connections and steel structures of the product have been inspected and certified as defect-free.	

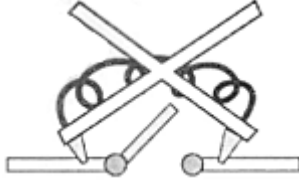
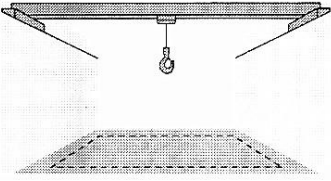
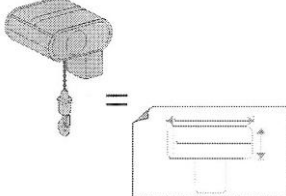
<p>3</p>	<p>Documentation</p> <p>At handover, check with your supplier that you have received all of the documents that you are supposed to have and that they correspond to the product. Owners SHALL ensure that all product documentation is available and is in the agreed language.</p>	
<p>4</p>	<p>Ensure availability of tools and equipment</p> <p>The owner must ensure that tools and equipment are available for installation, in accordance with the sales contract. Lifting equipment, man lifters and test loads may be required. Hand lines, securely attached to the building structure, should be used for lifting or lowering materials and tools. Use proper safety equipment to prevent objects from falling when working in high places.</p>	
<p>5</p>	<p>Allow sufficient time</p> <p>Owners must ensure that sufficient time has been reserved for installation and testing.</p>	
<p>6</p>	<p>Prevent unauthorized access to the site</p> <p>Owners must prevent unauthorized persons and bystanders from walking on or below the work site. Ensure that the secured area is spacious enough to prevent injuries which could occur as a result of falling components or tools.</p>	
<p>7</p>	<p>Minimize the risks of moving machinery</p> <p>Make sure that there is no possibility for personnel or body parts to be struck, crushed Or compressed by moving machinery. Owners must secure the area so that installation personnel are not at risk from the movements of machines, automatic doors or adjacent hoists at the installation site. Ensure that machinery and equipment cannot start accidentally and cannot move during installation and servicing. Maintain sufficient free space in the working area to reduce risks. Moving parts should be properly shielded with guards to prevent entrapment. Safety devices must never be overridden. Be prepared in case equipment moves in the wrong direction during testing.</p>	
<p>8</p>	<p>Ensure that the support structure is prepared for the product</p> <p>Owners must ensure that the support structure which the product is attached to is designed for the load of the product and meets the specific requirements and tolerances.</p>	

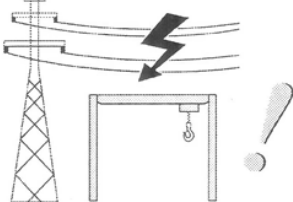
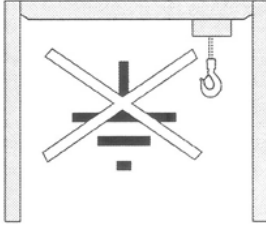
<p>9</p>	<p>Check the power supply is compatible</p> <p>Check that the supply voltage and frequency match the requirements of the product. Check that the installed bus bars are suitable for the product.</p>	
<p>10</p>	<p>Safety devices must be restored to operational status</p> <p>Ensure that any safety devices which have been bypassed for testing purposes have been restored to full operational status before allowing the product to be used for normal operation.</p>	
<p>11</p>	<p>Check the environmental and space requirements</p> <p>Ensure that the operating environment and space reserved for the product in the operating location is suitable for all functions of the product.</p>	
<p>12</p>	<p>Check for dimensional conformance</p> <p>Immediately following installation and prior to commissioning, check that the supplied parts conform to the drawings, instructions, parts lists and structural measurements. Discuss any non-conformance with the supplier immediately.</p>	
<p>13</p>	<p>Ensure that there are no hazards from loose items</p> <p>Items which are not properly secured to the product, such as tools or detached components, could move or fall accidentally, with potentially serious consequences. When dismantling the product, lower components to the ground at the earliest practical opportunity.</p>	
<p>14</p>	<p>Ensure that there are no electrical hazards</p> <p>Check for any electrical hazards in and around the working area and take appropriate steps to minimize them. Only properly trained personnel may perform electrical work on the product and they must use safe methods at all times.</p>	
<p>15</p>	<p>Take precautions if welding is done at the site</p> <p>If there is a need for welding to be done at the site: Provide suitable fire extinguishers. Do not allow the product structure or any of the components to be used for grounding. The hook must be isolated to protect it from providing a ground prior to welding. Do not weld on the hook.</p>	

2.9 Safety during Usage

This chapter only presents the owner's responsibilities towards the operator with regard to equipment usage. See instructions for the operator for detailed safety information concerning actual usage of the equipment.

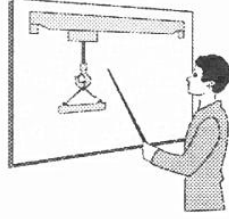
1	<p>Operator training</p> <p>Owners SHALL ensure that operators are properly trained. Operators must know how to operate</p>	
----------	--	---

2.10 Safety during maintenance

Before and during product maintenance, the product owner must take the following precautions:



NOTICE	Safe access to the product is the owner's responsibility.
---------------	--





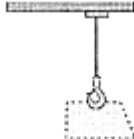

 CAUTION	Use experienced service personnel, authorized by the manufacturer of the product, for servicing the product. The person servicing the product must be competent for the task and must be familiar with the servicing and inspection instructions.
--	--

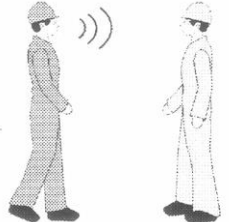
 CAUTION	After a collision or overload situation, inspection and repair operations to be carried out on the product must be discussed with the supplier.
---	--

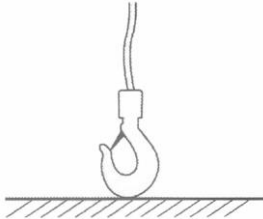
 CAUTION	Only use genuine spare parts approved by the manufacturer.
--	---

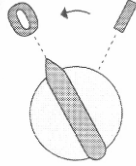
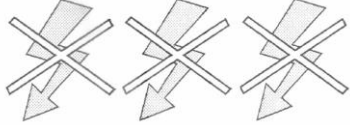
Before and during product maintenance, the product owner must be aware that the following precautions should be taken by maintenance personnel:

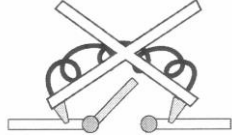
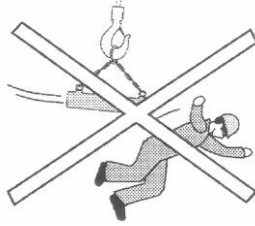
1	<p>Choose a safe working location</p> <p>The product should be moved to a location where it will cause the least disturbance and where it can be accessed easily.</p>	
2	<p>Prevent unauthorized access to the site</p> <p>Prevent unauthorized persons and bystanders from walking on or below the work site. For example, you can lock doors, install barriers and display notices. Ensure that the secured area is spacious enough to prevent injuries which could occur as a result of falling components or tools.</p>	
3	<p>Inform that equipment will be undergoing maintenance</p> <p>Before starting maintenance, people must be properly informed that the equipment is being removed from operation.</p>	

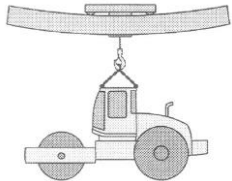
<p>4</p>	<p>Ensure that there is no load on the lifting device</p> <p>Before starting maintenance there should be no load on the hook or lifting device. Park the hook on the ground if there is any chance that the hoisting brake will be opened during maintenance. A raised empty hook will fall to the ground if the hoisting brake is opened.</p>	
<p>5</p>	<p>Use hand lines for lifting and lowering tools</p> <p>Hand lines, securely attached to the building structure, should be used for lifting or lowering materials and tools. Use proper safety equipment to prevent objects from falling when working in high places.</p>	
<p>6</p>	<p>Turn controllers off</p> <p>All controllers must be placed in the off position before starting maintenance.</p>	
<p>7</p>	<p>Verify that power is completely disconnected</p> <p>Measure between the phases and between each phase and ground to ensure that power is completely disconnected from the product.</p>	
<p>8</p>	<p>Lockout-Tagout</p> <p>The equipment power source must be locked out and tagged out when necessary, in accordance with local regulations. See chapter "Lockout-Tagout Procedure"</p>	
<p>9</p>	<p>Safety devices must be restored to operational status</p> <p>Ensure that any safety devices which have been bypassed for-testing purposes have been restored to full operational status before allowing the product to be used for normal operation.</p>	
<p>10</p>	<p>Minimize the risks of moving machinery</p> <p>Secure the area so that personnel are not at risk from the movements of machines, automatic doors or adjacent cranes at the installation site. Ensure that machinery and equipment cannot start up accidentally and cannot move during installation and servicing. Be prepared in case equipment moves in the wrong direction during testing.</p>	
<p>11</p>	<p>Perform regular inspections and preventive maintenance</p> <p>To ensure ongoing safe and efficient operation of the product, carry out regular inspections and preventive maintenance in compliance with the instructions. Keep a record of all inspections and servicing. If in doubt, contact the supplier of the product.</p>	
<p>12</p>	<p>Returning the product to operation after overload or collision</p> <p>After an overload or collision incident, the appropriate inspection and repair operations must be discussed with the supplier of the product.</p>	

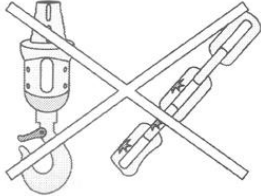
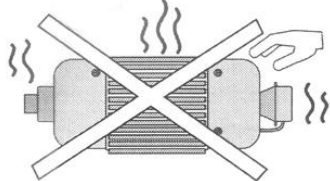
13	Pay special attention to all safety-critical components The brakes, limit switches, hook, chain and controller are all safety-critical items which must always be kept in good order. Ensure that safety devices (overload protectors, limit switches, etc.) work properly so that they provide protection against human error.	
14	Beware of high temperature components Some components of the product, such as the motors, can become very hot during use. Check that components are cool before working on them.	

2.10.1 Lockout-Tagout Procedure

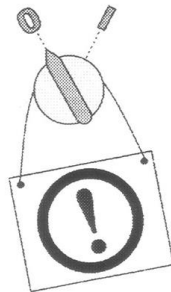

During installation, inspection and maintenance, lockout-tagout procedures must be followed in accordance with local regulations and the documented site lockout-tagout policy. The owner must ensure that the operators are fully aware of the applicable lockout-tagout practices.

Lockout-tagout procedures are primarily intended to protect personnel by preventing accidental starting or exposure to electric shocks. Individual locks and tags are placed on controls to prevent their use until the person who installed the lock or tag removes it

 CAUTION	Never attempt to operate a control, switch, valve or other device when it is locked out or tagged out.
--	---

Items which are normally included in the documented lockout-tagout policy:

- Communication requirements: who to inform before using lockout-tagout.
- When the use of lockout-tagout is permitted.
- Identification of each of the switches, controls, valves and other energy isolating devices present at the site. The role of each device should also be explained.
- The lockout-tagout sequences to be followed before, during and after maintenance.
- Safety and operational considerations regarding other products on the same runway or on adjacent runways.

2.11 Sound Intensity Level

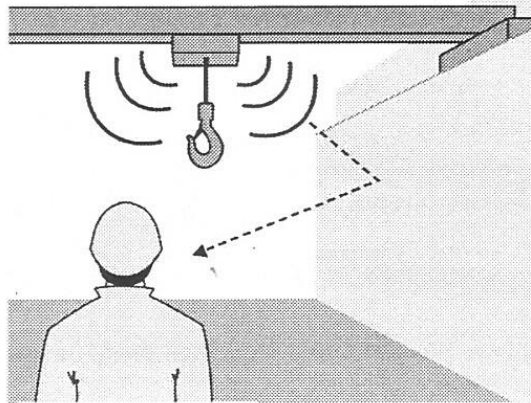

Hoists generate some audible noise during operation. The total noise level experienced in the operating area is a combination of the individual noise sources around the operator. The main sources of noise from the hoist arise from its components, vibrating structures and reflective surfaces.

Hoist components which generate noise:

- **Hoisting machinery**
- **Trolley, bridge or other moving structures associated with the hoist**

Typically, when the operating location is more than 5m (16ft) from the hoist and associated moving components, the average combined noise pressure level due to the hoist and its associated components will not exceed 65 dB(A) at the operating location. The noise pressure level rises as the operator moves closer to the sources of noise.

The noise pressure level can exceed 65dB(A) if, for example:

- **The operator operates the hoist from somewhere close to the moving components.**
- **The crane or building structures resonate heavily.**
- **The walls or other surfaces at the working site reflect noise towards the operator**
- **The optional warning devices are functioning**

If the noise levels seem high, measurements should be taken while the equipment is working under normal operating conditions. Follow local recommendations and use personal hearing protection if recommended.

3 IDENTIFICATION

3.1 Hoist identification data

The hoist serial number is stated on the hoist's data plate located on the hoist body and inside the electrical enclosure.

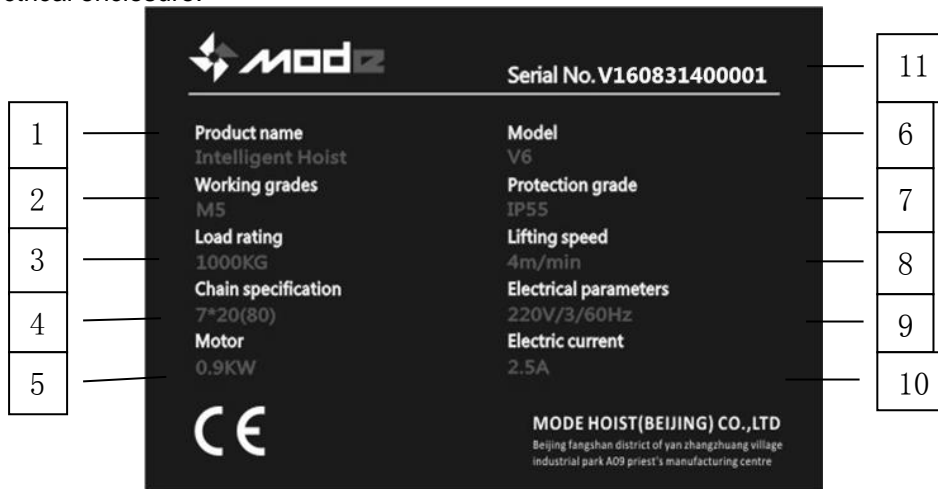

1	Name of the product
2	Work level of the product
3	Maximum load that can be lifted with the product
4	Diameter and pitch of the chain used
5	Power rating of the product
6	The product's type
7	Protection class type for enclosures
8	High/low hoisting speed
9	Voltage and frequency with which the product can be connected to a power source and phase quantity of the motor
10	electric current
11	A unique product identification number



Note: The example data in the above figure is shown for illustration purposes only and does not match the data on your product.



Note:

Duty class
Duty class H4 results in cycle time of 48 seconds and 300 starts per hour at 65% of rated load.
Duty class H3 results in cycle time of 48 seconds and 150 starts per hour at 65% of rated load.

3.2 Manufacturer

Manufacturer: MODEHOIST (BEIJING)CO.,LTD

Address: Beijing fangshan district of yan zhangzhuang village industrial park A09 priest's manufacturing centre



Note: For more information about the products, operation training, or services, please contact your supplier.

3.3 Standards and Directives

This state of the art product has been designed and manufactured to conform to European and international standards and directives. The product also fulfils the requirements of the following standards (if applicable): CSA, UL, OSHA, CCC,

4 CONSTRUCTION

4.1 Identifying the key parts of the hoist

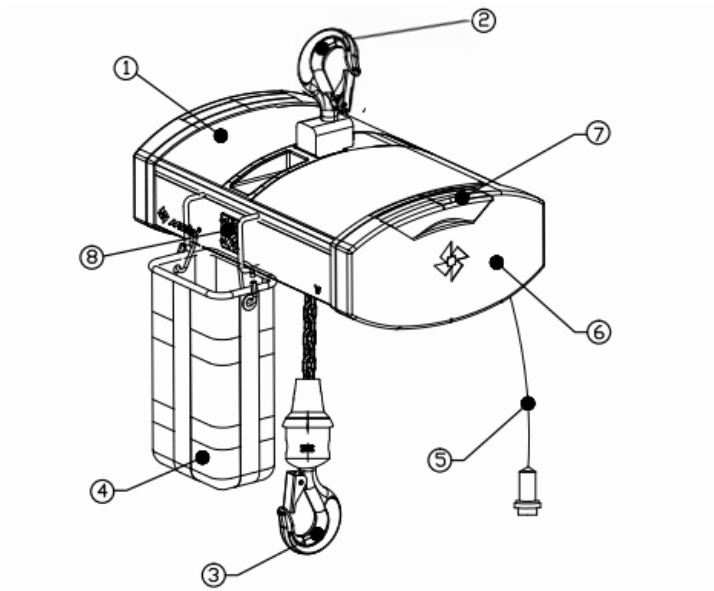

Pos.	Part	Description
1	Hoisting machinery	Equipment composed of hoist frame, hoisting motor, gear, clutch and brake
2	Upper hook	Rotating upper hook, normally used when hoist is operated in inverted position
3	Hook	Hook includes hook housing, hook forging and rubber grip
4	Chain bag	Bag where the lifting chain is gathered and stored
5	Control cable+ plug	Plug for connecting power or controls to the hoist
6	Buffers	Rubber buffers at each corner to protect hoist against external shocks
7	Handles	Integrated handles for easy carrying of hoist
8	Chain guide	Chain flux type chain guide for precise chain alignment

4.2 Main Functions

4.2.1 Hoisting Function

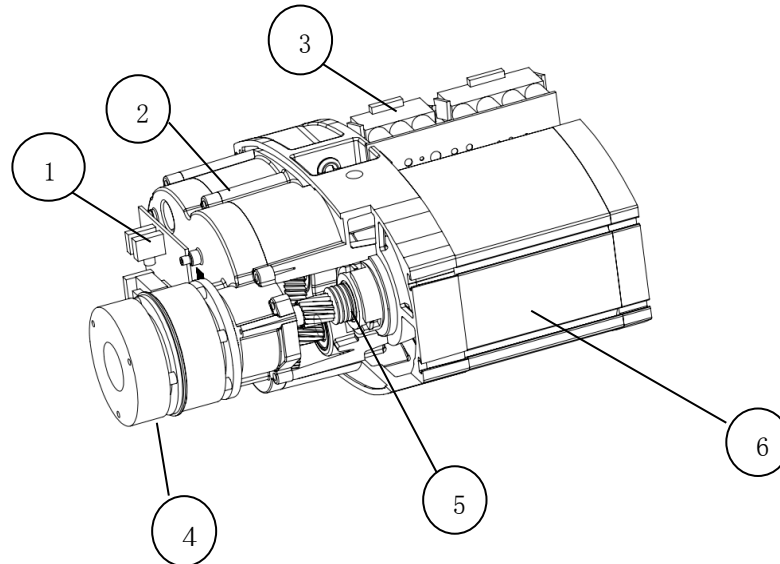

Pos.	Part
1	Electric panel 1 (configuration A)
2	Hoisting gear
3	Electric panel 2 (configuration B)
4	Brake
5	Slipping clutch
6	Motor

How the hoisting function works

The electric motor rotates the axle, which makes the hoisting gear helical steps turn. The gear transfers the motor power to the hoisting chain which then moves according to the selected direction (up/down).

The assembly includes a slipping clutch that allows the lifting of loads corresponding to 110% of nominal SWL (safe working load), and prevents the lifting of loads that exceed 160% of the SWL. An overload slips the clutch, allowing the motor to continue running while preventing the gearbox helical steps (and hoisting chain) from moving.

NOTICE

Only use the emergency stop button to stop movement in the event of malfunction or other emergency situation. Using the emergency stop button can cause the load to swing unexpectedly.

4.2.2 Safety Functions

Hoisting Unit

Device	Description
Emergency stop button	The emergency stop button is used to turn off power to the system in dangerous situations. The emergency stop button cuts the supply voltage to the system from the main contactor. Always eliminate the danger before releasing the emergency stop button. There are several types of emergency stop buttons but they are always red.
Slipping clutch	Slipping clutch protects the machinery against overloading. Overload occurs at around 110% of the rated capacity of the hoist. When activated, the slipping clutch prevents further hoisting but it is still possible to lower the load. Never use the slipping clutch to assess the weight of the load.
Second disc brake (holding brake) (option)	The second disc brake (holding brake) supports the load if the main brake fails. The main brake and auxiliary brake are assembled on the same hub. When the hoisting motion is required, the service brake and the auxiliary brake are energized simultaneously from the brake board. When the hoisting motion is topped, the service brake is switched off immediately while the auxiliary brake stays energized for a few milliseconds by the motor inductive effect.
Upper and lower limit switch	The hoisting limit switch is adjusted to prevent the hoist from traveling too high or low. The upper limit switch stops upward movement so that only lowering is possible. The lower limit switch stops downward movement so that only hoisting is possible.

4.3 Signs

4.3.1 Safety Signs

Safety signs inform the operator about potential hazards and also about special features concerning the product's operation.

	Failure to avoid dangers identified by these signs can result in death or serious injury.
---	--

Sign	Description	Location on product
	Danger of electric shock	On electric cubicle and other cubicles.

5 INSTALLATION



Before installation, read instructions in chapter “Safety first”.



Installation procedure requires special skills and tools to ensure safe and reliable operation of the product. Installation work shall be carried out only by authorized service personnel or an experienced service technician authorized by the product's manufacturer.

5.1 Installation preparations

The product is packed in a box for transportation. To remove the hoist from the box, first remove the temporary transport supports.

Chain bucket is not fixed to the hoist during transportation, so lift the hoist and chain bucket from the box simultaneously. Notice that the chain connects the bucket and the hoist.

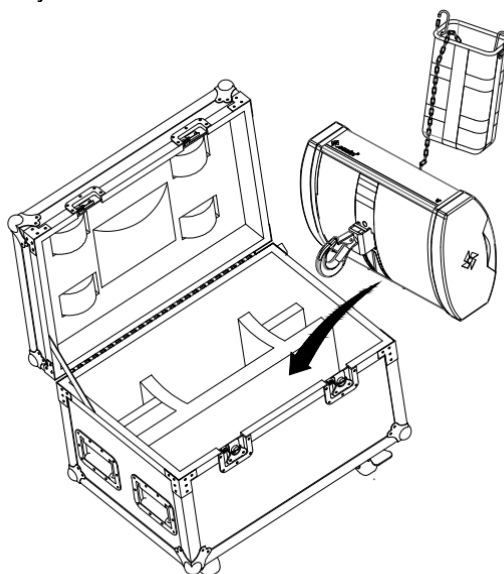

WARNING

Do not bundle the chain into the chain bucket.

Fitting the chain bucket

If the hoist has been stored for a long time or has been transported by sea, check that the

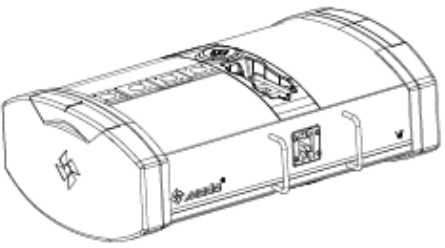
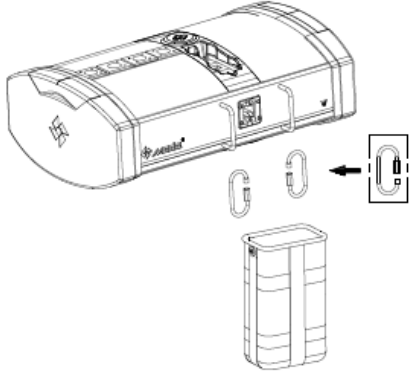
<p>1</p>  <p>The chain bucket connection parts are fixed to the hoist enclosure with screws.</p>	<p>2</p>  <p>Attach the chain bucket to the connection part with screw-lock carabiner.</p>
---	--

Motors are dry. Move the hoist to the installation location.

	<p>Read instructions in chapter “Lifting the hoist” Before lifting the hoist.</p>
---	--

5.1.1 Lifting the hoist

Evaluating the weight of hoist

It is important that you know the weight of the hoist before commencing lifting so that you can select an appropriate lifting device and prevent overloading. The weight of the hoist can often be found from the packing list, the technical documents or the data plate.

 <p>WARNING</p>	<p>Never lift a load that is heavier than the rated capacity of the lifting device. The load will fall if the lifting device fails.</p>
---	--

 <p>WARNING</p>	<p>Never attempt to lift a load before ensuring that it weighs less than the maximum permitted load of the auxiliary lifting devices. Overloading can damage the auxiliary lifting devices.</p>
---	--

 <p>WARNING</p>	<p>Do not use any overload device like the slipping clutch to determine whether the load can be lifted. Overload devices are not accurate enough and a load which does not trigger the overload device may still be heavier than the maximum permitted load. Overloading can damage the auxiliary lifting devices.</p>
---	---

Auxiliary lifting device

The hoist is usually lifted by using an auxiliary hoist and some kind of lifting device. The most common lifting devices are chains, wire rope slings and lifting belts. Every lifting device must be clearly marked with the maximum capacity and must be approved by authorities.



Always follow instructions provided by the lifting device manufacturer and the local authorities! As the manufacturer of the hoist we are not responsible for lifting accessories provided by other manufacturers.



WARNING

Never use a lifting device which does not clearly display the maximum capacity or is not approved by authorities. The load falls down if the lifting device fails.



WARNING

Never use a lifting device which is unsuitable for the purpose. The load falls down if the lifting device fails.



WARNING

Never use a damaged lifting device. Carefully inspect lifting devices before using them. The load falls down if the lifting device fails.

Before lifting

Check that the load is balanced and safely fastened at the lifting points. The load must not be able to slide, slip or detach itself when suspended.



WARNING

Do not move the load before ensuring that it is properly attached to the lifting device. Moving the load prematurely can cause serious injury.



WARNING

Use lifting devices in accordance with the manufacturer's instructions.



WARNING

An unbalanced load is likely to drop and/or damage the product. Slings and harnesses must be positioned so that the pulling force of the auxiliary lifting devices lies on the hoist's center of gravity.



Note: When you begin the lifting, check that the load is properly balanced before lifting it high off the ground. If the load is not balanced, lower it down and adjust the lifting point.



WARNING

If the load is not balanced, do not try to support it with your hands. Lower the load down and adjust the lifting point again.

Lifting points

Lifting points, if available, are marked with a sticker. Refer to chapter “Information signs used on the hoist”.

Hook-suspended models

Lift the hoist from suspension hook

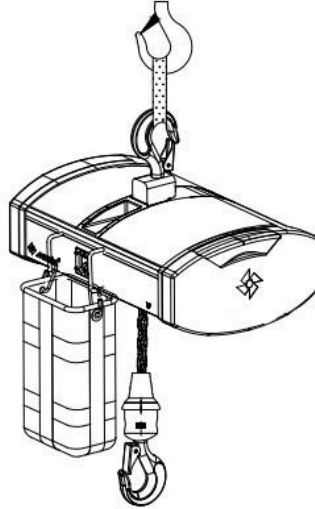

5.2 Electrical connections



Only qualified electrician shall make any electrical connections.



WARNING

Electrical connections shall be made according to wiring diagrams provided with the product.



WARNING

Power supply shall be OFF and locked before making any electrical connections. Lockout-tagout procedures must be followed in accordance with local regulations. Refer to chapter “Lockout-Tagout procedure”.



Note: There are wires hanging from the connector of hoist that were used in manufacturing. They shall be removed later as instructed.

Installing Pendant Cable Cable Inputs

Configuration A		Configuration B	
1		2	

Pos.	Part
1	Power supply
2	Control Cable

Carry out the following procedures before connecting the hoist to the main network:

1	Check that the rated voltages correspond to the main voltage. Voltages and frequencies marked on the data plate of motors driven by inverter can deviate from the values on the data plate for the hoist.
2	Check that the power supply to the hoist is protected with fuses of the correct size.
3	Check that the phase sequence is correct.
4	Check carefully all connections.

Connecting the hoist to power supply

1		2	
	Remove wires from power socket and open cable gland to remove wire from the assembly.		Place the main power cable through the cable gland to the connector and connect wires to socket. Pay attention to the order of wires to ensure correct phase sequence.
3			
	Slide the assembly in place and connect the socket. Close the cover and tighten to correct torque.		

6 COMMISSIONING



Note: Before handing over the equipment, proper commissioning shall be done. Inspections and adjustments are listed in "Installation and commissioning instructions".

	The equipment shall not be used before proper commissioning.
--	---

	The commissioning procedure requires special skills and tools to ensure safe and reliable operation of the equipment. Commissioning shall be carried out only by authorized service personnel or an experienced service technician authorized by the manufacturer or manufacturer's representative.
--	--

	Before commissioning the instructions in chapter "Safety first" shall be read.
--	---

	CAUTION	Any defects or abnormalities which are detected during commissioning must be investigated and corrected in accordance with the instructions relevant to component in question.
--	----------------	---

NOTICE	Local requirements may demand other commissioning testing to be performed before the equipment can be taken into use. Make sure all of the local requirements are fulfilled.
---------------	---



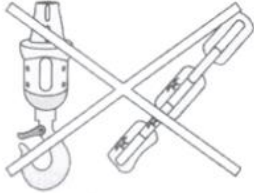
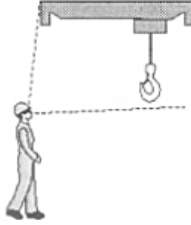

6.1 Commissioning preparations

	During installation, commission and maintenance, lockout-tagout procedures must be followed in accordance with local regulations and the documented site lockout-tagout policy. Refer to chapter "Lockout -Tagout procedure".
--	--

1	Ensure that there are no hazards from loose items	
	Items which are not properly secured to the product, such as tools or detached components, could move or fall accidentally, with potentially serious consequences.	

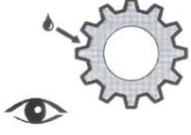
2	<p>Pay special attention to all safety-critical components</p> <p>Note any damaged parts from installers or in shipping.</p>	
3	<p>Check the environmental and space requirements</p> <p>Check that no permanent or temporary obstructions are in the way of the hoist when the hoist is operated.</p>	

6.2 Checks before first run

1	<p>Lubrication</p> <p>Check the lubrication of chain and the traveling and hoisting gear. Check that traveling gear box is vented.</p>	
2	<p>Bolted connections</p> <p>Check bolted connections. Bolts need to be torqued with a proper torque wrench. Check installation of jam and locking nuts. Refer to chapter "Tightening torques".</p>	
3	<p>Electrical connection</p> <p>With the product disconnect OFF, check the proper electrical grounding of the product. Check that the connections of electrical devices comply with the wiring diagrams and meet local requirements. In particular, check connections that affect the safety and controlling of the equipment. Check the condition of wiring and connections.</p>	
4	<p>Chain</p> <p>Check that the chain has not been damaged during transport or twisted. Check the fixing of chain ends. Check that the chain is correctly lubricated according to the instructions given in chapter Lubrication.</p>	
5	<p>Hook</p> <p>Check the hook. Check to ensure that the hook safety latch is on the hook, is in good condition and closes automatically. Check that the hook forging rotates freely. Measure the dimension of hook opening of the suspension hook and hook block. Note it for a follow-up.</p>	

6.3 Test Run Without Load

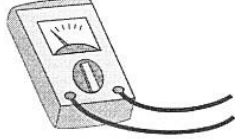
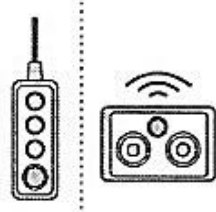
<p>1</p>	<p>Electrical connections</p> <p>Check the cableways for electrical wiring. Make sure that wires do not snag on structures when the hoist is moving.</p> <p>Check that the rated voltages correspond to the main voltage. Check that the power supply to the hoist is protected with fuses of the correct size. Check that the phase sequence is correct.</p> <p>The voltages and frequencies marked on the data plate of motors driven by inverter can deviate from the values on the data plate for the hoist.</p> <p>Check possible fault messages from hoist control device and inverters (not in all models).</p>	
<p>2</p>	<p>Controller</p> <p>Check that the controller is correctly installed and in good condition. The controller shall not cause any disturbance for other controllers. Check the functionality of push buttons, joysticks and switches.</p> <p>Check that all motions occur to the correct direction. Make sure that desired functions occur when operating the push button, joystick or switch. Check that the hook movement corresponds to the control direction.</p>	

NOTICE

Check that the hook moves in correct direction by pressing first the UP direction button (though the hook is near the upper limit).

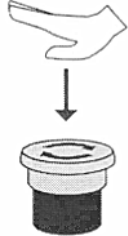
<p>3</p>	<p>Emergency stop button</p> <p>Check the operation and condition of the emergency stop button.</p>	
-----------------	--	---

NOTICE

Only use the emergency stop button to stop movement in the event of product malfunction or other emergency situations. Using the emergency stop button can cause the load to swing unexpectedly.

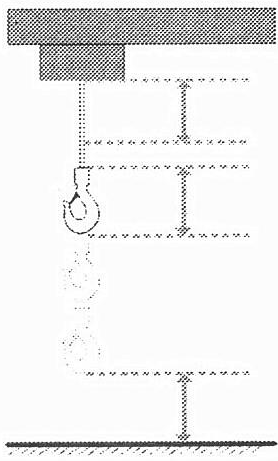
<p>4</p>	<p>Hoisting limit switch If the hoist is equipped with electrical limit switches, check for correct operation of the limit switches by raising and lowering the hook at low speed until the limit switches are activated and prevent further upward or downward movement. In case the desired function is not activated at desired position, adjust the limit switches according to the adjustment instructions given under 'Operational Checks with Controller Enabled'. If that does not help, geared limit switch needs to be replaced.</p> <p>Functional description of the limit switch</p> <p>2-step geared limit switch The 2-step geared limit switch together with controls is working as an adjustable upper and lower stop limit.</p> <p>4-step geared limit switch The 4-step geared limit switch provides an adjustable upper and lower stop limit connected to the internal controls. Two (2) cams are not connected to the controls, and can thus be freely used for end-user requirements.</p>	 <p>The diagram illustrates a hoist system. At the top, a shaded horizontal bar represents the ceiling or support structure. A hook is suspended from this bar. Below the hook, a vertical shaft is shown with several horizontal lines representing gears or limit switch components. The hook is shown in two positions: one higher and one lower, indicated by dashed lines. The lower position shows the hook closer to a shaded horizontal bar at the bottom, representing the ground or a lower stop.</p>
-----------------	---	--

	<p>Traveling limit switches shall always be adjusted before the commissioning tests can be continued.</p>
---	--

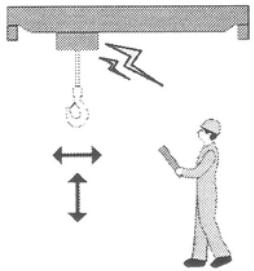
<p>5</p>	<p>Operating sound and movements</p> <p>Listen to the operating sound when the product is hoisting or traveling. Pay attention to unusual noises such as squealing. Check that the hoist is running smoothly. There should not be any strong vibration.</p>	 <p>The diagram shows a hoist system with a hook and a lightning bolt symbol indicating noise or vibration. A person is standing next to the hoist, looking at it. There are arrows indicating the hoist's movement: a horizontal double-headed arrow and a vertical double-headed arrow.</p>
-----------------	--	--

<p>CAUTION</p>	<p>Any defects or abnormalities which are detected during the commissioning must be investigated and corrected in accordance with the instructions relevant to the component in question.</p>
-----------------------	--

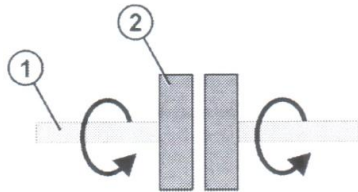
<p>6</p>	<p>Slipping clutch</p> <p>Check that the slipping clutch mechanism works correctly. When the torque caused by load (1) exceeds the designed hoisting limit, the clutch discs (2) should begin to slip, preventing upward hoisting movement.</p>	 <p>The diagram shows a slipping clutch mechanism. It consists of a horizontal shaft with two vertical discs (2) mounted on it. A load (1) is applied to the shaft, causing it to rotate. The rotation is indicated by curved arrows. The discs (2) are shown slipping, preventing upward hoisting movement.</p>
-----------------	--	---

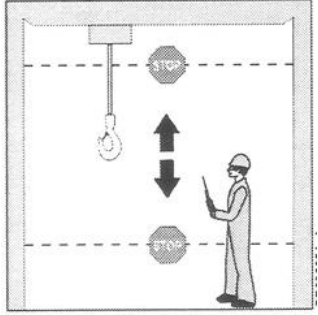
7	<p>Brake operation</p> <p>Check that the hoisting brake operates correctly in both upward and downward directions.</p>	
---	---	---

6.4 Test run with test load

	<p>The test load shall be securely fastened and properly balanced.</p>
---	---

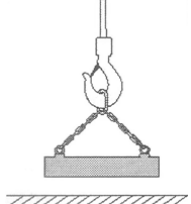
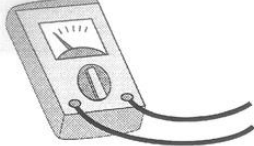
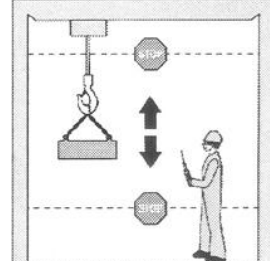
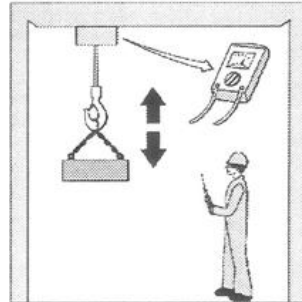
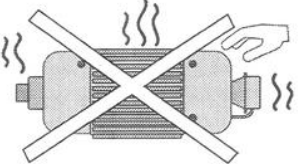
1	<p>Static and dynamic tests</p> <p>The equipment shall be tested with dynamic tests 110% of the nominal load and static tests with 125% of the nominal load. Make sure that the hook will not turn around while lifting.</p>	
2	<p>Power supply measurements</p> <p>Check that voltage is over the required minimum value under 100 % load.</p>	
3	<p>Brake operation</p> <p>Check that the brake is able to stop the motion adequately.</p>	
4	<p>Motor current</p> <p>Check the motor current in each phase during hoisting motion with rated load. The current should be in balance in all phases and may not exceed the ratings for the motor. Check the current at both hoisting speeds.</p>	
5	<p>Running temperature</p> <p>If the thermal protection halts hoisting prematurely, identify the reason for overheating before continuing the commissioning tests.</p>	

CAUTION	Local requirements may demand other commissioning testing to be performed before the product can be used. Make sure all the local requirements are fulfilled.
----------------	--

	All optional features shall be tested before using the product.
---	--

6.5 After test runs

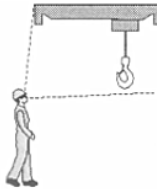
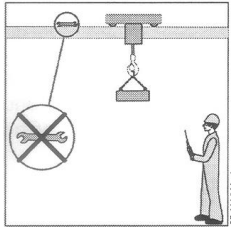
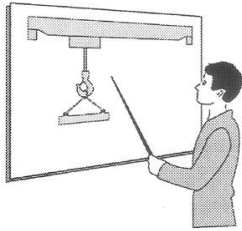
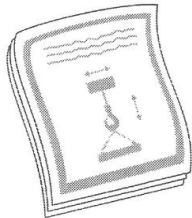
1	Visual check Check visually that the hoist or any other part has not been damaged in any way during commission testing.	
2	Cleaning Check that all tools and materials used during installation are removed from the hoist and track.	
3	User training Ensure that the hoist operator and supervision personnel are aware of the need for user training. The authorized service organization of the hoist manufacturer can arrange user training by separate agreement.	
4	Handover documents Check the documents delivered with the hoist. Ensure that entries in the documents are properly recorded and that the reference data in the documentation matches that on the type rating plates. Compile a commissioning log for the hoist and store it together with the other documentation for the hoist.	

7 INSTRUCTIONS FOR THE OPERATOR



7.1 Operator's Responsibilities



Hoists are used for various purposes, handle different types of loads and are operated different ways by many operators. Many workers, as part of their regular job responsibilities, normally operate hoists as non-dedicated operators.

Because the manufacturer of the hoist has no direct involvement or control over the hoist's operation and application, conforming to good safety practices is the responsibility of the owner, and the equipment's operating personnel. Only those Authorized Personnel and Qualified Personnel who can demonstrate that they have read and understood this manual and that they understand the proper operation and maintenance of the product should be permitted to work with it.

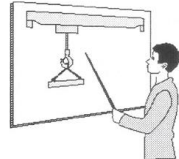
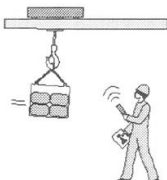
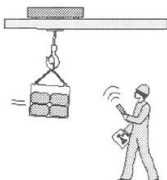
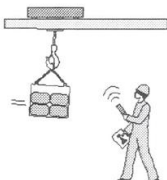
	<p>Failure to adhere to the instructions and warnings provided in this manual can result in serious injury or death.</p>
---	---

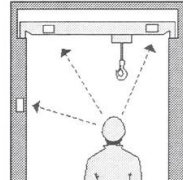
Operators SHALL:

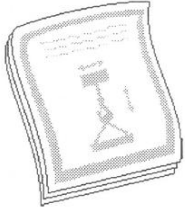
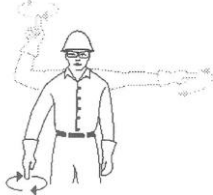
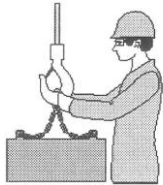
1	Operators SHALL be trained by the owner of the equipment or a qualified designee and be competent for the task.	
2	Operators SHALL learn how to operate the equipment safely before actually starting to work with it.	
3	Operators SHALL know all the controls and must be able to use them correctly and safely.	
4	Operators SHALL learn how to control the movements of the hook and load.	
5	Operators SHALL be aware of any risk of accident posed by the operating site.	
6	Operators SHALL familiarize themselves with the signs and warnings marked on the equipment.	

7	Operators SHALL use this manual to familiarize themselves with the equipment and equipment's controls.	
8	Operators SHALL learn the hand signals for directing equipment's movements.	
9	Operators SHALL be familiar with proper rigging procedures.	
10	Operators SHALL carry out daily inspections	
11	Always follow the local regulations.	

Operators SHALL NOT:

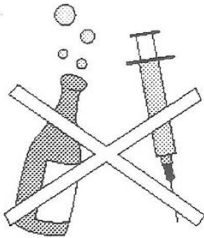
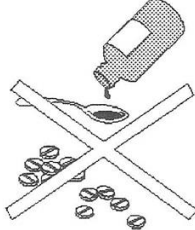
1	Operators SHALL NOT operate the equipment when under the influence of alcohol or drugs. Alcohol and drugs can impair judgment and thereby cause a hazard.	
2	Operators SHALL NOT operate the equipment when under medication which may cause a hazard to the operator or others. If unsure, consult your doctor or pharmacist. Always comply with local regulations regarding working under the influence of medication.	

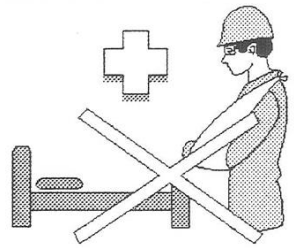
3	Operators SHALL NOT operate the equipment while suffering from any illness or injury which might impair their ability to properly use the equipment.	
---	--	---

7.2 Checks to Be Done Before Every Working Shift



Before every working shift, the operator SHALL make the following checks to ensure that the product is in a safe operating condition. By carrying out these simple checks, the operator can identify potential problems at any early stage, thereby enhancing safety and minimizing down time.

 CAUTION	If any abnormal condition or malfunction is noted on the daily inspection or occurs during daily operation, report it to the supervisor immediately and remove the product from use. Operation may only continue when safe operation is ensured.
--	---

 WARNING	Operating a product with an abnormal condition or malfunction can result in serious injury or death or serious damage to the product.
--	--

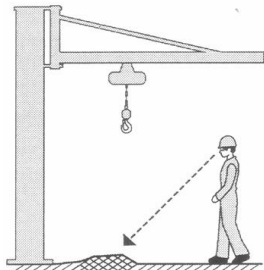
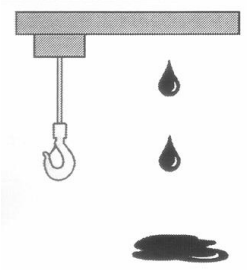
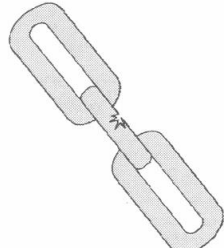
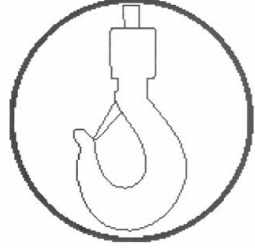
7.2.1 Checks to be performed by the operator

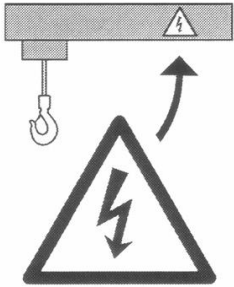
1	<p>Visually check the operating environment to make sure that there are no new hazards which might prevent safe use</p> 	2	<p>Visually check to see if there are any oil leaks from the product.</p> 
3	<p>Visually check the chains for any deformation or damage or twist (in 2 falls models). Check the chain for cleanness and proper lubrication.</p> 	4	<p>Inspect the hook for nicks, gouges, deformation of the throat opening, wear on saddle or load bearing point, and twisting.</p> 

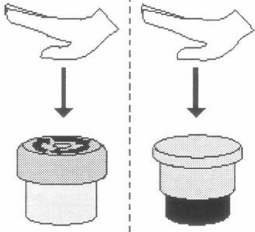
5	Check that all warning signs are in place, in good condition, and can be read easily. See section Signs.		6	<p>Never operate the product if it is locked or tagged out. Follow local safety procedures.</p> 
7	Check that the emergency stop button is down.		8	Check the condition of controller cable.

7.2.2 Operational Checks with the Emergency Stop Button Pushed Down

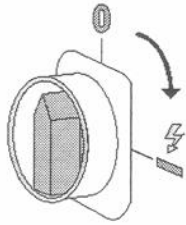
1	<p>Turn on the main power isolation switch.</p> <p>After the main isolation switch has been turned on, the product becomes operational (energized)</p>	
---	---	--

 <p>WARNING</p>	<p>If the emergency stop button is faulty, the product might move unexpectedly warning during the following checks. Unexpected movements during checks could result in death or serious injury.</p>
---	--

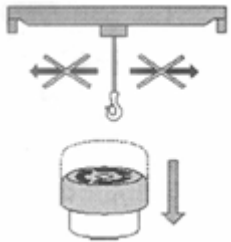
2	<p>Emergency stop button</p> <p>With the emergency stop button pushed down, check that the product does not move when the direction controls are pushed. This verifies that the emergency stop button is working properly.</p>	
---	---	---

7.2.3 Operational Checks with Controller Enabled

Before every working shift, all of these checks must be done with the emergency stop button released and with the power turned on.

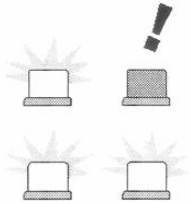
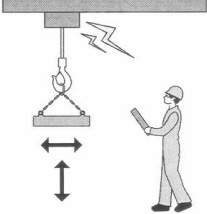
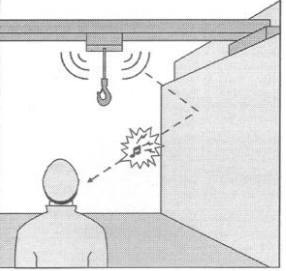
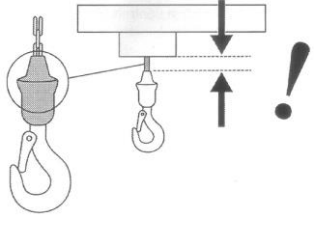
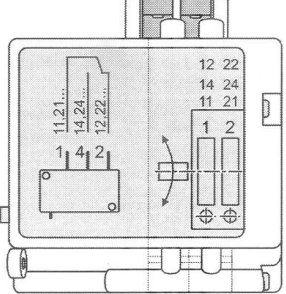
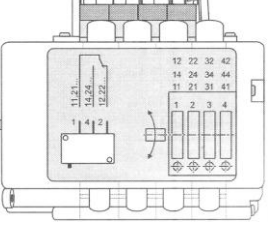
1	<p>Warning devices</p> <p>Check that all warning devices (for example, pilot lamps, LEDs, displays, horns, gongs, bells, sirens, beacons, strobe lights) are working correctly before using the hoist.</p>	
2	<p>Control devices with power</p> <p>Starting at low speed, check that movements correspond to the controller labels. Check that the brakes operate in all directions and that the speed increases as it should do in relation to the control.</p>	
3	<p>Noise</p> <p>Listen for unusual noises.</p>	
4	<p>Upper and lower limit switches (Configuration B)</p> <p>Check the condition of the rubber pad on top of the hook and also on the other end of the chain, at the chain bag. The plastic rings activate the upper and lower limit switches on the hoist. If a plastic ring is broken then it is a sign that a limit switch is not functioning correctly.</p> <p>Check for correct operation of the limit switches by raising and lowering the hook at low speed until the limit switches are activated and prevent further upward or downward movement.</p> <p>Hoisting limit switch</p> <p>Adjusting the limit switch</p> <p>First check the operation of the limit switch, see instructions under Test Run Without Load'.</p> <p>After checking the operation of the limit switch:</p> <p>In case the hoist is equipped with geared limit switch, the cutting points of this device need to be adjusted before hoist operation starts. Geared limit switch is accessed by opening the end cover of hoist from the brake side. Adjustment is done by turning the setscrews (1)... (4) (depending on the number of switching elements):</p> <p>Turning to the left: switching point is moved "downwards". Turning to the right: switching point is moved "upwards".</p> <p>2-step geared limit switch</p> <p>Setscrew 1 is the down limit and setscrew 2 the upper limit.</p> <p>4-step geared limit switch</p> <p>Setscrews 1 and 2 are the down limit and setscrews 3 and 4 the upper limit.</p> <p>HOL</p>	 <p>2-step geared limit switch</p>  <p>4-step geared limit switch</p> 

	The maximum height of lift with geared limit switch is the following:			
	Frame size	HOL [m] (ft.)		
		Ratio 180		Ratio 280
	SR02	20(65)		30 (98)
	SR05	25(82)		39(127)
SR10	36(115)	56(180)		
5	Safety latch Check to ensure that the hook safety latch is on the hook, is in good condition and closes automatically.			

 WARNING	Never release the emergency stop button and drive the product until you are sure that it is safe to do so. Releasing the emergency stop button and driving the product when it is unsafe to do so could cause death or serious injury.
--	---

7.3 Movements

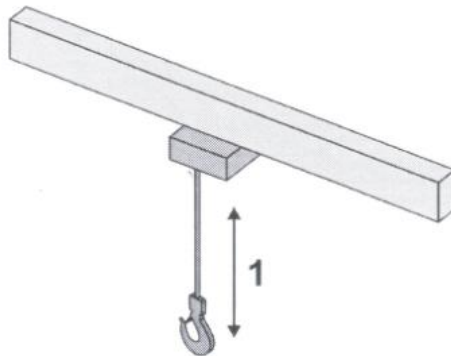

The hoist moves in the following directions

Movements	Description
1. Hoist movements	Vertical up and down movements of the lifting device

Essential prerequisites for this section

 WARNING	When operating the product, make sure that there are no people situated underneath or nearby the load. Operating the product when people are underneath or near the load could cause death or serious injury.
--	--

NOTICE	Do not deliberately use limit switches to stop the motion. Always stop the motion by using the control devices on the controller.
---------------	--

NOTICE	If the product malfunctions during use, push the emergency stop button and contact the supervisor.
---------------	---

 **Note:** Motors get hot when they are turning, even without a load on the hook. Operate the motors at the highest practical safe speed because low speeds generate more heat. Allow the motors to cool down frequently so that they do not overheat. Refer to the owner’s manual for the maximum permissible continuous operation times. If a motor gets top hot then the thermostat will prevent further operation.

7.3.1 Motor Control Methods

The components are controlled by a variety of electrical circuits called “drive circuits”. The motors can all be driven by the same type of drive circuits or a mixture of types.

 **Note:** Sudden speed changes increase wear on motors and brakes.

7.3.2 Lifting and Lowering Motions

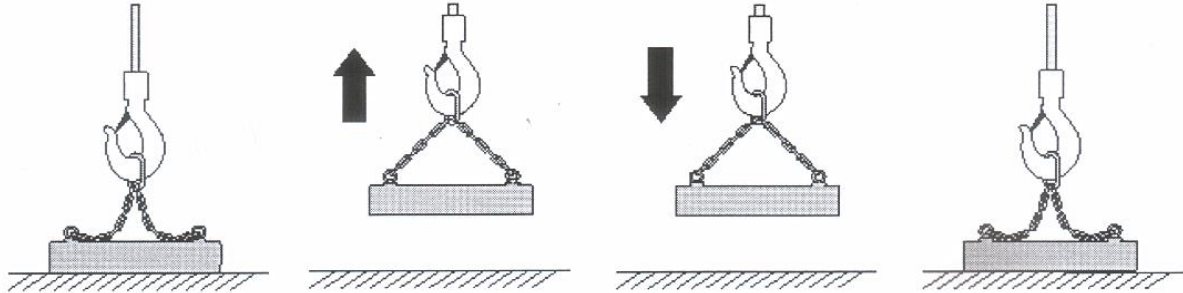

Before lifting
After securely attaching the load to the lifting device, the hoist must be correctly positioned and attached to perform the lift. The following steps must be followed before lifting.

 WARNING	Moving a load that is not properly attached to the lifting device could cause death or serious injury.
--	---

 **Note:** Do not attempt to lift a load which is fastened to the ground or to a base which will prevent it from being lifted.

7.4 Load Handling

Correct load handling allows the operator to move loads quickly and safely.

 WARNING	<p>Handle the load safely at all times. During movements, ensure that the hook, the load, the product and its moving parts will not collide with objects or people. Failure to do so could cause death or serious injury.</p>
---	--

Evaluating the load

To prevent overloading, the operator shall determine the weight of the load before lifting. The operator shall only lift the load when he or she is sure that it weighs no more than the permitted load of the product and accessories. The product's overload device shall not be used to determine whether the load can be lifted.

Never attempt to lift a load that weighs more than the maximum permitted load of the equipment and accessories.

 CAUTION	<p>Attempting to lift a load that weighs more than the maximum permitted load of the equipment and accessories could cause death or serious injury.</p>
---	--

Balancing the load

The hook, slings and harnesses must be positioned so that the pulling force of the product lies on the load's center of gravity so that the load is balanced. When the operator begins to hoist a load, he or she shall check that it is properly balanced before lifting it high off the ground. If the load is not balanced, lower it down and adjust the lifting point.

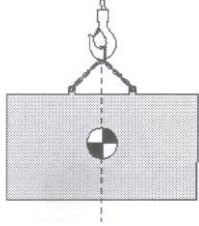
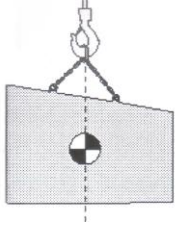
<p>1</p> <p>Lifting centrally balanced loads</p> <p>The center of gravity will usually be in line with the center of the load. Provided that the contents of the container cannot move around, the balance of the load stays the same.</p>	
<p>2</p> <p>Lifting off-center balanced loads</p> <p>The center of gravity of an off-center balanced load will usually be towards the heavier end of the load. Provided that the contents of the container cannot move around, the balance of the load stays the same.</p>	

 WARNING	<p>Never try to balance an unbalanced load with your hands. Lower the load and adjust the lifting point. Trying to balance an unbalanced load with your hands could cause death or serious injury.</p>
---	---

Shock loading

The hoist and accessories are designed to take up the weight of loads gradually and steadily. They are not designed to withstand sudden increases or decreases in the apparent weight of the load. Shock loading can occur in any situation where the load on the hoist suddenly increases or decreases. Some examples of how shock loading can occur are shown below.

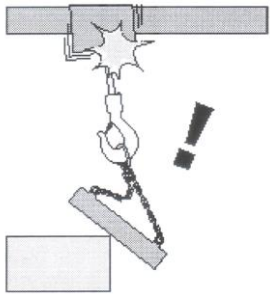
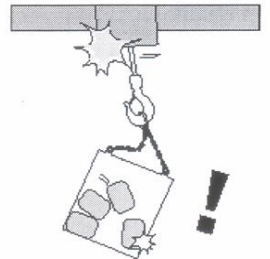
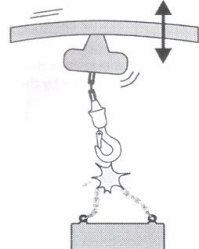
<p>1</p>	<p>Change of load balance</p> <p>A change in load balance can suddenly pull on the hoisting rope or chain.</p>	
<p>2</p>	<p>Unstable load</p> <p>If the load is unstable, it can exert sudden force on the hoisting rope or chain. The contents of packing cases should be securely fastened so that they cannot move around during lifting.</p>	
<p>3</p>	<p>Rapid load reduction</p> <p>A sudden loss of the load can cause the trolley/hoist to jump.</p>	

<p>NOTICE</p>	<p>Avoid shock loading the product. Shock loading the product could damage the product or the load.</p>
----------------------	--

 <p>CAUTION</p>	<p>After a shock load equipment shall not be used before authorized service personnel or an experienced service technician authorized by the manufacturer or manufacturer's representative has determined that the equipment is safe to use. The usage of a defective product can result in serious damage, injury or death.</p>
---	---

Attaching the load

The load is usually attached to the product by means of some kind of under-the-hook lifting device. The most common under-the-hook lifting devices are chains, wire rope slings and lifting belts. The operator shall select a lifting device designed for the product being transported.

	<p>Always follow instructions provided by the lifting device manufacturer when using under-the-hook lifting devices. Never use the product's ropes or chains as a sling to attach to the load.</p>
---	---

Load handling

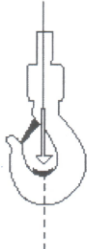
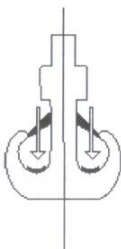
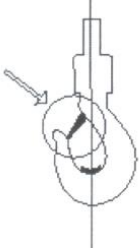
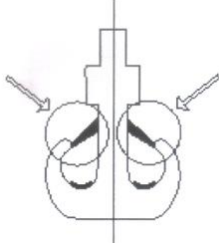
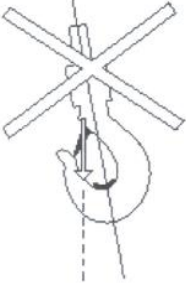
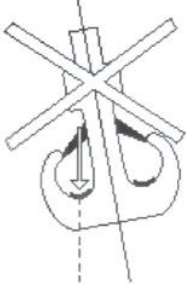
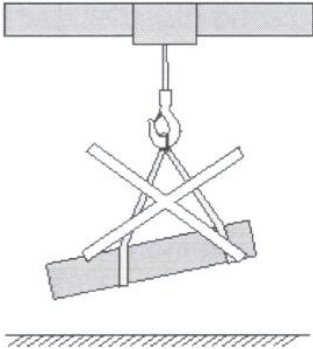
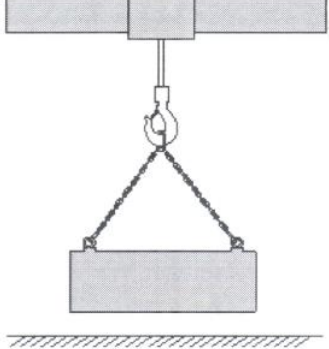
<p>1</p>	<p>To avoid damaging the hook, lifting devices must only be positioned on the load bearing surface of the hook. That is, the lowest point of the hook. Forces on ramshorn hooks must be equal on both load bearing surfaces.</p>		
<p>2</p>	<p>Ensure that the hook safety latches are closed. Check that the safety latch is not subjected to any force by the load</p>		
<p>3</p>	<p>The weight of the load must be centered on the center line of the hook forging so that the load does not bend the neck of the hook. Never try to lift anything with the tip of the hook!</p>		
<p>4</p>	<p>Check that the load is balanced and safely fastened at the lifting points. The load must not be able to slide, slip or detach itself when suspended.</p>		

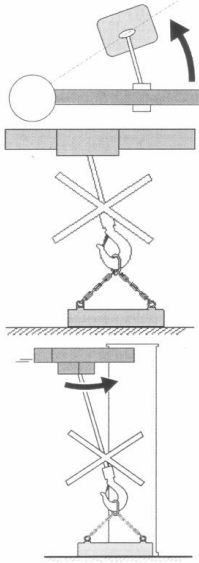
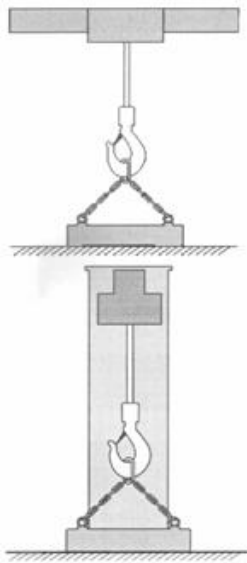
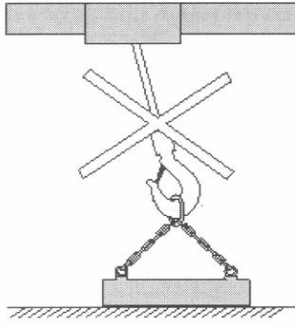
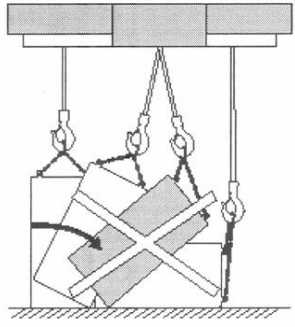
<p>5</p>	<p>The hoist must be positioned directly above (perpendicular to) the load so that there are no side-pulling forces. The jib arm is liable to swing towards a load which is not situated directly under the hoist.</p>		
<p>6</p>	<p>Do not drag the load along the ground.</p>		

NOTICE	Never drag loads or pull loads from the side.
---------------	--

NOTICE	Never twist the load chains.
---------------	-------------------------------------

NOTICE	Never swing the load intentionally.
---------------	--

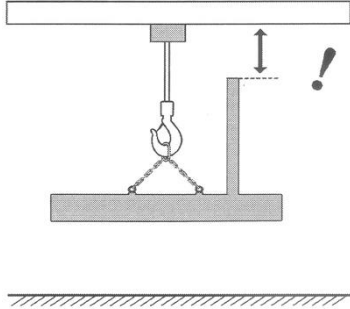
<p>7</p>	<p>The operator shall ensure that the hoist or the load does not collide with anything or fall from the lifting device.</p>	
-----------------	---	--

NOTICE	Observe the load at all times while it is in motion to ensure that it does not collide with anything or fall from the lifting device.
---------------	--

NOTICE	Never add load to a lifted hook. Always lift load from the floor.
---------------	--



NOTICE	Do not drive the hook to the bottom of the hoist. Do not drive the chain out of the chain bag up to the slack fall stop. These may brake the chain and allow the load to drop.
---------------	---

Lifting

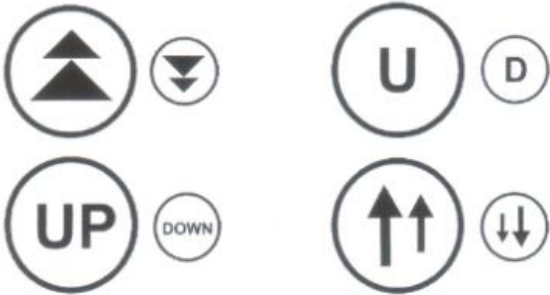
 WARNING	Never touch the ropes, chains or slings during lifting. There is a risk of catching or trapping your hands in the hook block or hoist. Catching or trapping your hands in the hook block or hoist could cause serious injury or death.
--	---

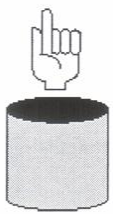
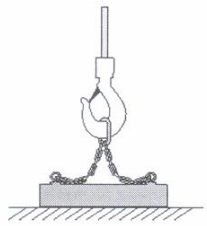
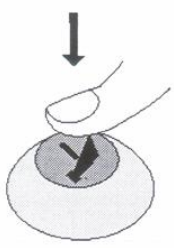
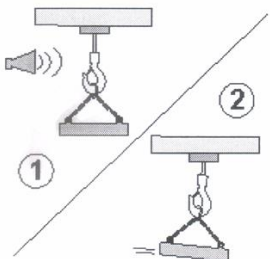
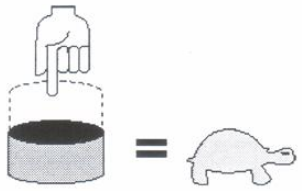
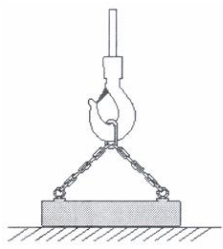

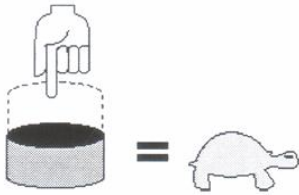
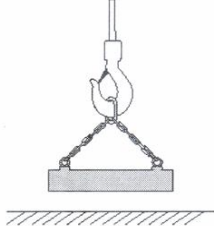
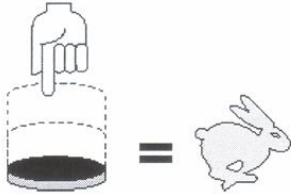
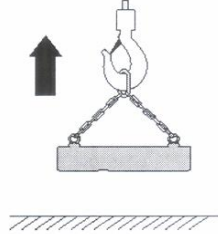

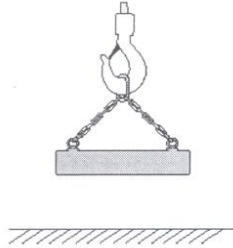
1	Ensure that everything is ready for lifting.		
2	If the crane has a horn, push the horn push button to warn people nearby that a load is about to be moved.		
3	Gently push the UP push button to slowly take up the slack from the chains or sling before lifting the load from the ground.		

4	Continue to push the UP push button until the load is just clear of the ground.		
5	Push the UP push button to lift the load at high speed.		
6	Release the UP push button gently when the load is at the desired height. Do not raise the load higher than is needed to avoid colliding with objects.		

NOTICE	Do not raise the load higher than necessary to avoid colliding with objects on the ground during movements.
---------------	--

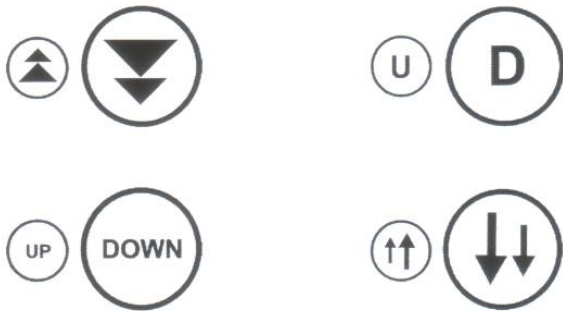
Lowering



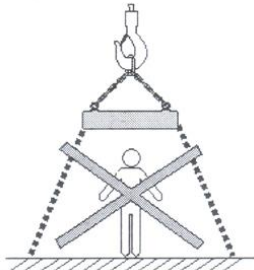

1	Ensure that the landing area is clear of people and obstacles.		
---	--	---	---

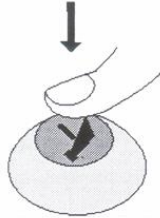
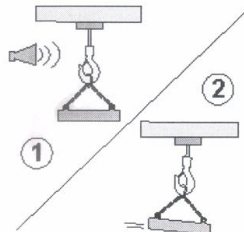
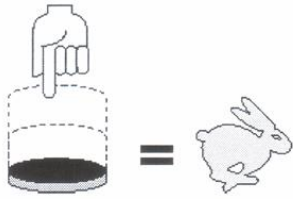
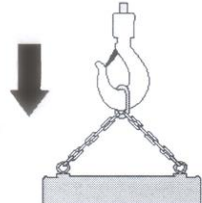
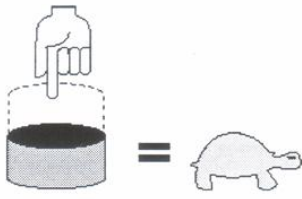
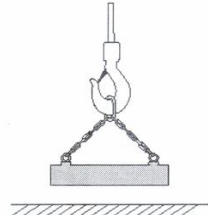

WARNING

When operating the hoist, make sure there are no people situated underneath or nearby the load. Operating the hoist when people are underneath or near the load could cause death or serious injury to those situated underneath or near the load.

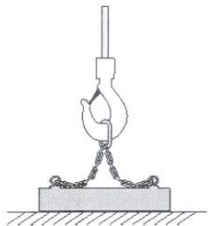
<p>2 If the crane has a horn, push the horn push button to warn people nearby that a load is about to be moved.</p>		
<p>3 Push the DOWN push button to lower the load.</p>		
<p>4 Decrease the lowering speed by gradually releasing the DOWN push button when the load is approaching the ground.</p>		
<p>5 Fully release the DOWN push button when there is slack in the lifting device but before the hook or lifting device impacts the load.</p>		

Detaching the Load

Always remove the load from the hook by hand. Never try to use crane motions to remove the load from the hook. The safety latch on the hook should prevent this.

7.5 Load Control

The operator must use the correct techniques to properly control the load at all times to prevent uncontrolled movements such as load swing or rotation.

If the load has a tendency to rotate or swing, a third person can guide the load with a tag line, provided that it is safe to do so.

Guiding or steadying loads by hand

Guide and steady the load by controlling it by hands.



 WARNING	Never PULL on the load or chain because, by doing so, it is easy to get trapped and crushed, for example between a wall and the moving load. Only move the trolley by PUSHING on the chain or load.
--	--

 WARNING	Never try to stop load swing with your hands. A swinging load moves with considerable force. Your hands or body could be seriously injured between the load and an obstacle or wall.
--	---

 WARNING	Guiding or steadying suspended loads directly with your hands is prohibited. Use a tag line to guide the load or a more suitable lifting device. Your hands or body could be seriously injured between the load and an obstacle or wall.
--	---

7.6 Safety Procedure After Using the Hoist

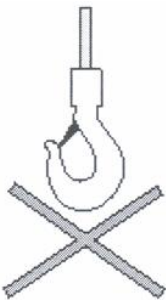
The following checks must be done **after every working shift** to ensure that the hoist is in a safe condition.

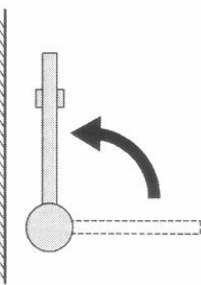
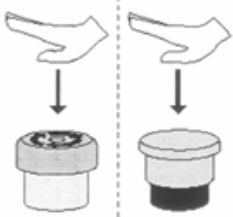
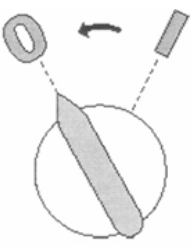
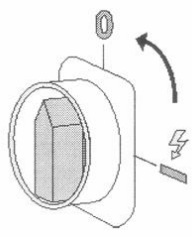
1	Ensure that there is no load on the lifting device unless it is designed for that purpose (e.g. the BGV-C1 hoist).		2	Park the hook or other lifting device where it will not present a hazard to people or traffic but do not park at the top safety limit. Above head height is recommended.	
3	If applicable, park the jib arm so that it does not obstruct the movement of other hoists, for example.		4	Engage the emergency stop button.	
5	Turn off all controls on the controller .		6	Turn off power to the hoist.	

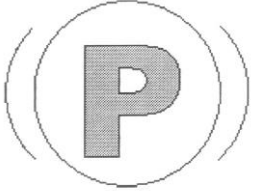
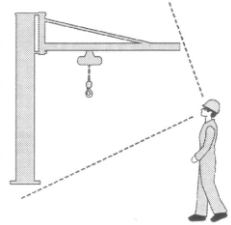
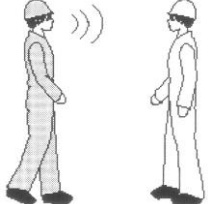
7	If applicable, close mechanical brakes such as rail clamps, storm locks etc.		8	Check the hoist for any visible damages.	
9	Report all observed defects and abnormalities in equipment or operation to the foreman and to the next operator.				

 WARNING	Always remove the product from service immediately if it is in a dangerous W/U^NING condition. Operating a product that is in dangerous condition could cause death or serious injury.
--	---

7.7 Hand Signals and Other Methods of Communication

When one person is operating the product and another is giving hoisting instructions, communication must be clear. Both people must agree on and understand the language they use to describe hoisting actions.

If electronic voice communication is used, such as telephone or radio, a dedicated channel must be used so that any commands from other personnel in the area will not confuse the operator.

ANSI standard hand signals can be used for communication (see Appendix - ANSI standard hand signals). Other standards for hand signals exist. The operator must be trained in the use of appropriate hand signals. A copy of the hand signals should be displayed at the operator's station and anywhere else where it could be useful.

Special operations may require additional hand signals. Special signals must be agreed upon and understood before hoisting. It should not be possible to confuse special signs with the standard signs.

The operator should only respond to hand signals from the person giving hoisting instructions, except to obey a stop signal, regardless of who gives it. The operator takes overall responsibility for movement and should only follow movement instructions when he or she judges it safe to do so.

8 MAINTENANCE

8.1 Why You Must Care About Maintenance

- It is the **product owner's responsibility** to organize proper regular inspections maintenance to ensure long-term safety, reliability, durability, operability and warranty for the product. Keep this manual in a safe, accessible location during the whole lifetime of the product.
- The owner must keep a record (log book) of all maintenance activities and usage relating to the product.
- Different maintenance actions must be carried out at different intervals and by different persons, all of whom must be qualified and authorized to perform the checks which relate to them.
- Daily checks and minor lubrication must be carried out by operators. These checks are very important to catch small faults before they become major faults.
- Maintenance actions, excluding the daily actions performed by operators, must be done by service personnel who are authorized by the manufacturer or manufacturer's representative.
- The owner shall ensure that replacement parts and materials meet the specifications defined by the product manufacturer.



WARNING

Do not modify the product without the manufacturer's permission. Any modifications to the product structures or performance values must only be made after they have been approved by the product's manufacturer.

NOTICE

Modifying the product without the manufacturer or manufacturer's representative approval can invalidate the guarantee. Furthermore, the manufacturer does not accept responsibility for accidents which happen as a consequence of unauthorized modifications.



WARNING

Failure to regularly and properly maintain the product can result in death, injury or damage.



WARNING

Do not allow the product to be used if it is not in proper condition. Contact a service agent authorized by the manufacturer or manufacturer's representative immediately in case of doubts! The usage of a defective product can result in serious damage, injury or death.



CAUTION

Only use genuine spare parts, materials and lubricants approved by the product's manufacturer or manufacturer's representative. Consult your spare parts catalog for further information.



Before maintenance the owner must see the instructions in chapter "Safety first"

8.2 Service Personnel

Only authorized service personnel or an experienced service technician authorized by the manufacturer or manufacturer's representative may perform the detailed examinations necessary for scheduled maintenance. Such examinations must be performed in accordance with the inspection and maintenance plan provided by the product's manufacturer. The original manufacturer or manufacturer's representative has approved authorized service personnel to maintain its products.

The owner or operator of the product must perform the daily checks and, if required, daily lubrication. Service personnel authorized by the owner may also lubricate the product at the necessary intervals.



Note: Mechanical and electrical maintenance work requires special skills and tools to ensure safe and reliable operation of the product. Maintenance work shall be carried out only by authorized service personnel or an experienced service technician authorized by the product's manufacturer or manufacturer's representative.

8.3 Inspections

The operator/owner of a product shall carry out regular inspections to ensure the safe operation. The product's owner shall also keep record of the inspections and findings.

Periodic inspections must be carried out by authorized service personnel or experienced service technician authorized by the product's manufacturer or manufacturer's representative. Inspections must be carried out according to manufacturer's instructions.



Note: If the working environment or product usage changes, the inspection and maintenance intervals may need to be revised.



Note: Products used under harsh conditions may require shorter service intervals. Consult with the manufacturer or manufacturer's representative for a tailored service agreement.



Note: Periodic inspections SHALL be carried out in accordance with local regulations.



CAUTION

Any defects or abnormalities which are detected during the inspections must be investigated and corrected in accordance with the instructions relevant to component in question.

8.3.1 Daily Inspections

Daily inspection items are listed in chapter "Instructions for the operator5". In most cases these checks will be performed by operators.

8.3.2 Monthly inspections

General

Component	Objective
Chain	Check the cleanness and lubrication of chain
Slipping clutch	Check the operation of slipping clutch

8.3.3 Quarterly inspections

General

Component	Objective
Chain	Measure the wear of the chain
Limit switches	Check condition and operation of limit switches
	Verify correct operating position of limit switches
Hook block	Check operation and condition of hook block
	Check condition of hook forging and safety latch
	Check free rotation of hook forging
	Tighten the hook block screws

8.3.4 Annual inspections

General

Component	Objective
Hoist	Check the general condition and cleanness of hoist
	Check the condition of fixing of covers
Stickers and markings	Check condition of warning etc. stickers, readability
Instructions and log books	Check readability of instructions
	Check validity of log book

Limiting devices

Component	Objective
Buffers	Check condition of buffers and buffer end stops.
Limit switches	Check condition and operation of limit switches.
	Verify correct operating position of limit switches (if the hoist is equipped with limit switches).
Slipping clutch	Check condition and operation of slipping clutch and adjust if needed.

Electrics

Component	Objective
Emergency stop	Check operation and condition of emergency stop button (only in option with push button controller).
Main switch	Check operation and condition of main switch (not in configuration A).
Wiring	Check condition of wiring and connections.
Cubicle	Check security of fastenings in the electrical cubicle.
Contactors	Check operation and condition of contactors (not in configuration A).
Slipping clutch	Check condition and operation of slipping clutch and adjust if needed.

Motors and gears

Component	Objective
Motors	Check operation of motors
	Check fastenings of motors
Brakes	Check the operation and wearing of brake
	Check the tightness of brake screws
Gears	Check operation of gears
	Check for leakages

Mechanical component

Component	Objective
Chain	Check condition and position of chain
Hook block	Check operation and condition of hook block
	Check condition of hook forging and safety latch
	Check free rotation of hook forging.



Note: The product may have options which also require inspection. Make sure that all components are inspected.

Checking the brake lining

For accessing the control electrics and brake, remove the end cover as follows.

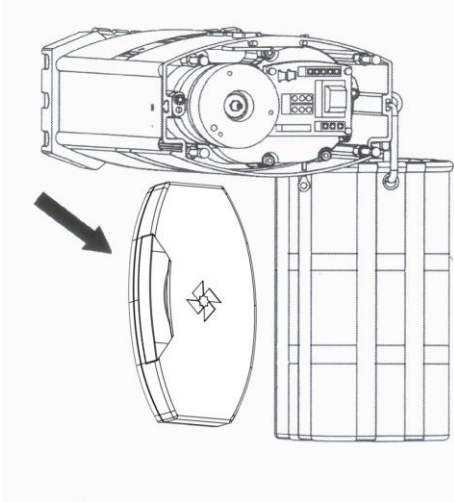
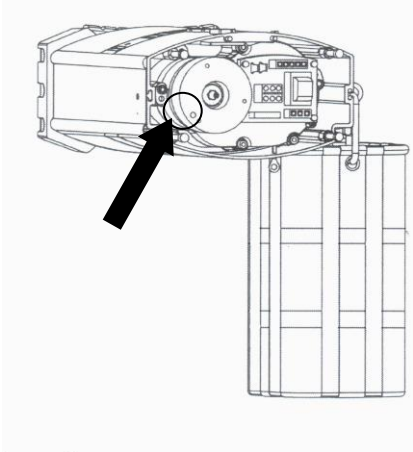
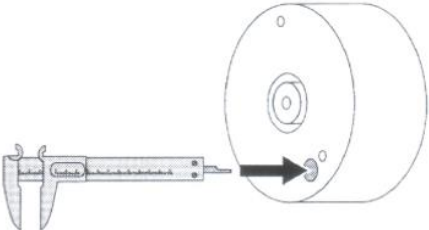
1	 <p>Remove the cover.</p>	2	 <p>Locate the check hole in brake assembly.</p>
3	 <p>Measure the gap with a caliper.</p>		

The maximum values for the brake measurement are:

Ar20°C (68°F) [mm] (in)	
02	25.3(0.996)
05	25.3(0.996)
10	30.0(1.181)

Brake lining criteria is indicated in the sticker next to the measurement hole.
 In case that brake has worn more than maximum criteria, contact authorized service personnel for brake change.

Replacing the Brake Single Brake

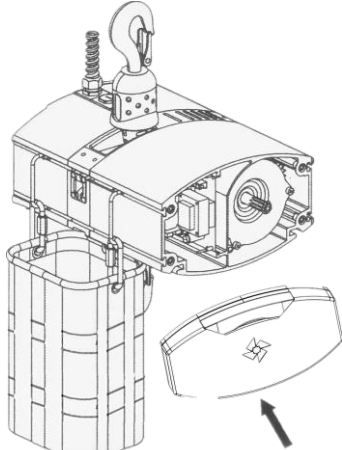
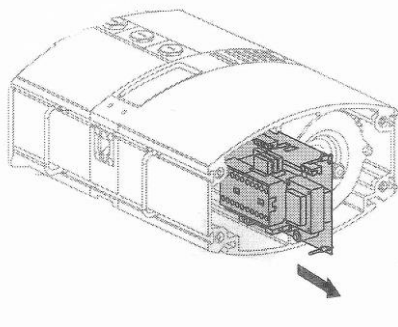
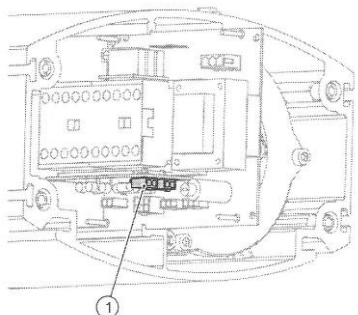
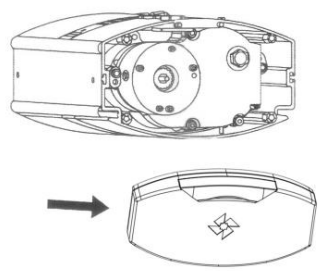
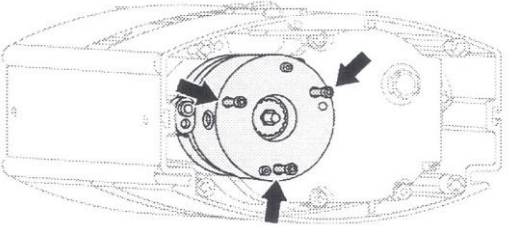
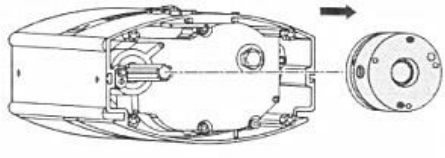
1	 <p>Open the motor side cover.</p>	2	 <p>Pull out the electrical board.</p>
3	 <p>When the electrical board is a few centimeters (inches) out, unplug the brake plug(1) from its socket.</p>	4	 <p>Open the brake side cover. Pull the brake cable with the brake plug carefully out on the brake side.</p>
5	 <p>Unscrew the three screws of the brake.</p>	6	 <p>Remove the brake by pulling it out.</p>

7	To assemble the new brake, proceed in reverse order.	
---	--	--

Double Brake
1st step: Dismounting the double brake

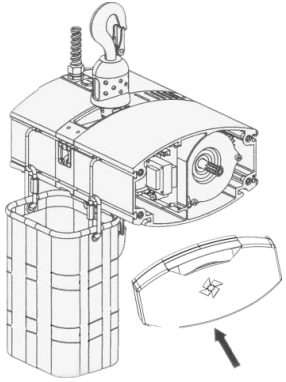
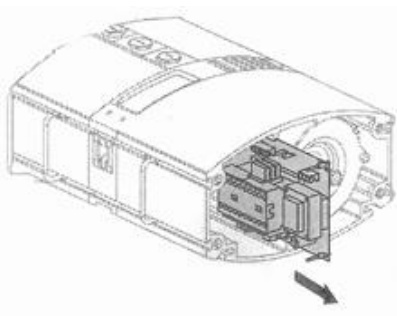
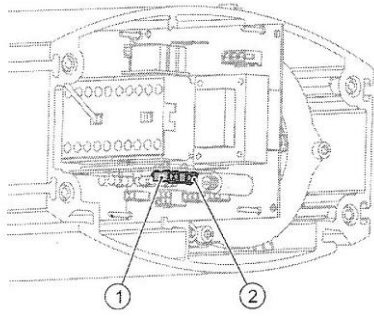
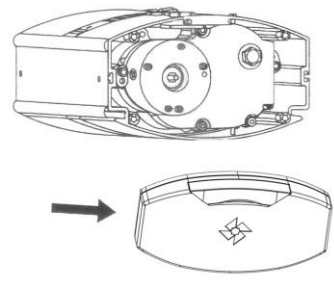
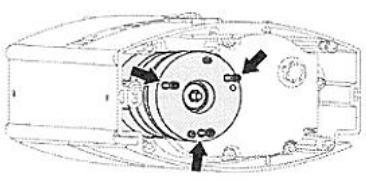
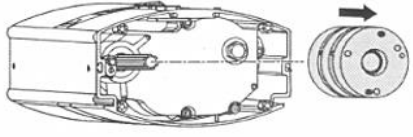
1		2							
	Open the motor side cover.		Pull out the electrical board.						
3		4							
	<p>When the electrical board is a few centimeters (inches) out, unplug the brake plug (1) and (2) from their sockets.</p> <table border="1" style="width: 100%; border-collapse: collapse;"> <thead> <tr> <th style="text-align: left;">Pos.</th> <th style="text-align: left;">Description</th> </tr> </thead> <tbody> <tr> <td style="text-align: center;">1</td> <td>Brake1</td> </tr> <tr> <td style="text-align: center;">2</td> <td>Brake2</td> </tr> </tbody> </table>	Pos.	Description	1	Brake1	2	Brake2		Open the brake side cover. Pull the brake cable with the brake plugs carefully out on the brake side.
Pos.	Description								
1	Brake1								
2	Brake2								
5		6							
	Unscrew the three screws of the brake.		Remove the brake by pulling it out. NOTE: Hold the complete double brake with your hands so that the parts do not fall apart.						

2nd step: Mounting a new double brake

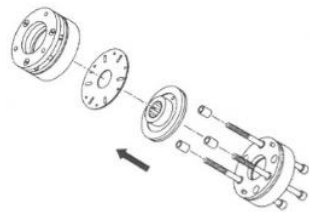
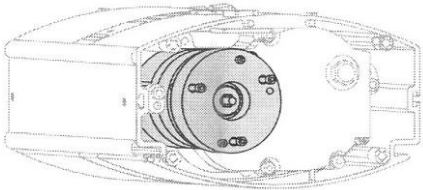
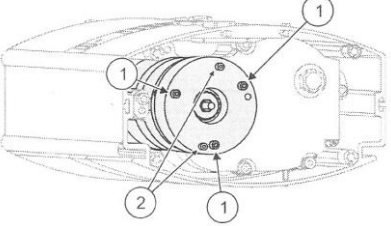
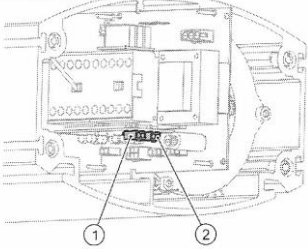
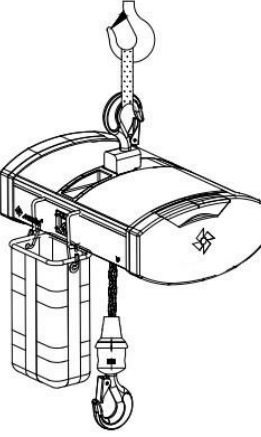
7	 <p>Assemble the brake according to the picture. NOTE: Pay attention to the orientation of the lining.</p>	8	 <p>Put the double brake in position and pre-tighten the screws by hand</p>						
9	 <p>Tighten the screws (1) with a tool. Remove the two other screws (2).</p> <p>NOTE: The top brake is the main brake; the bottom brake is the safety brake.</p>	10	 <p>Plug the brake plugs on their correct sockets.</p> <table border="1" data-bbox="900 936 1343 1034"> <thead> <tr> <th>Pos.</th> <th>Description</th> </tr> </thead> <tbody> <tr> <td>1</td> <td>Main brake</td> </tr> <tr> <td>2</td> <td>Safety brake</td> </tr> </tbody> </table>	Pos.	Description	1	Main brake	2	Safety brake
Pos.	Description								
1	Main brake								
2	Safety brake								
11	 <p>Close the motor and brake side covers.</p>								

 <p>CAUTION</p>	<p>After completing the work on the brake, the brake function must be tested with rated load</p>
---	---

 **Note:** The clutch must be re-adjusted after the brake has been replaced.

Adjusting the clutch

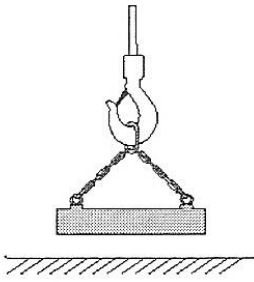
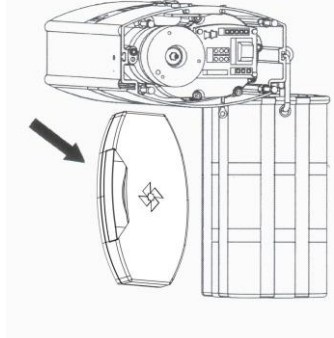
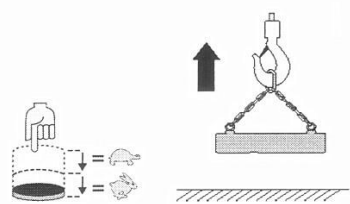
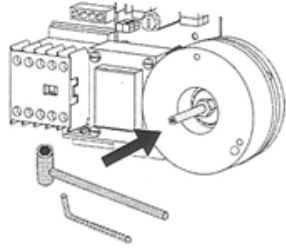
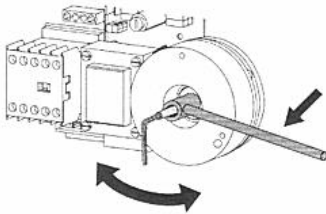
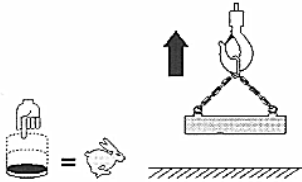
<p>1</p>	 <p>Hook a load of 1.25times the nominal load into the hoist.</p>	<p>2</p>	 <p>Remove the cover.</p>
<p>3</p>	 <p>Raise the load at slow and fast speed.</p>	<p>4</p>	 <p>Use a key to turn the adjusting screw in the required direction.</p>
<p>5</p>	 <p>Turn the screw clockwise to increase the torque, counterclockwise to decrease the torque. Unscrew the nut to adjust the setting with the screw and tighten the nut to lock the setting when it's correct.</p>	<p>6</p>	<p>Repeat steps 3 and 4 until the load can barely be lifted at fast speed. The slipping clutch is now adjusted. Close the cover.</p>
<p>7</p>	 <p>Check, at fast speed, the lifting of a nominal load.</p>		



WARNING

Do not touch the moving components. Before pressing the "lift" button on the control box, check that there is nothing in contact with the adjusting nut (key, for example).



CAUTION

When the slipping clutch is adjusted the motor must not be running.



Note: The value of the factory setting is 1,4 x the nominal load because friction lining is not run in yet



Note: To adjust the slipping clutch, it is recommended to use the chain force measuring device. Never the less, it is possible to use loads.





8.4 Lubrication





8.4.1 General lubrication instructions

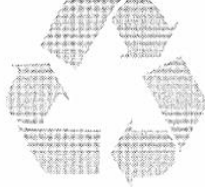

Note: The bearings in the product have lifetime lubrication. There is no need to add lubricant to the bearings | under normal operating conditions.

The following table provides advice on the lubrication procedures to be followed..

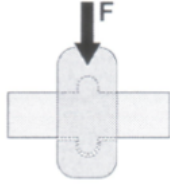
1	<p>Usage of a low grade or incompatible lubricant can damage the gearing or bearings. Use only lubricants recommended by the product's manufacturer. See the lubricant tables for more information.</p> <p>Use only fresh oils/greases. Different kinds of greases shall not be mixed up.</p> <p>Information about each chemical's safe handling, risks and handling as waste are described in the Safety Data Sheet that is available from manufacturer of the lubricant.</p> <p>Note: equipment may have synthetic lubricant as a factory installed lubricant. Please refer to order confirmation.</p>	
2	<p>Handle lubricants carefully. Prevent leakages to waters, sewers, cellars and other closed places.</p>	
3	<p>Keep lubricants away from heat and open fires. Do not smoke.</p>	
4	<p>Avoid contact with skin. Protection gloves and safety goggles shall be worn when handling lubricants. Hands shall be washed thoroughly after lubrication.</p>	

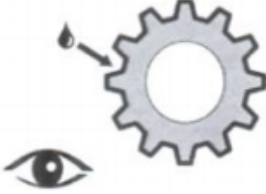
5	Keep lubricants away from food and drink. Do not inhale any fumes or swallow lubricants.	
6	Used lubricant shall be handled as hazardous waste following local legal requirements. Store used lubricant in containers indicated for the purpose and dispose by a licensed company.	
7	Keep grease nipples clean.	
8	All slide bearings must be depressurized for the grease to be able to penetrate.	
9	While lubricating, check the functioning of the bearings and observe whether there is any bearing slackness.	
10	The specified lubrication periods apply in favorable conditions and normal use. More frequent lubrication is recommended in more demanding conditions and in heavy use, particularly of the slide bearings.	
11	Verify that the gear teeth of the open gear transmission are entirely lubricated.	



Note: Do not use excessive lubricant. Excessive grease may cause the bearings to overheat and reduces the lifetime of the bearings.

8.5 Lubrication charts

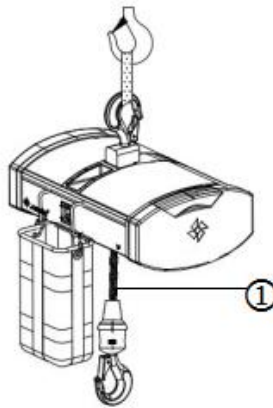

Pos.	Component	Intervals
1	Chain	Monthly



Note: Lubricate only instructed components. Other parts are lubricated for lifetime.

1	<p>Chain</p> <ul style="list-style-type: none"> To extend chain lifetime, lubrication is recommended. Lubrication interval varies from month to one year depending on usage. Lubrication shall be done before signs of corrosion or dryness. Lubricate the chain with suitable lubrication. Lubricant for chain shall be water resistant, non-adhesive, transparent thin oil, which is able to penetrate. Only lubricate the chain lightly, excessive lubrication may cause dribbling <table border="1"> <thead> <tr> <th>Installation</th> <th>Trade name</th> <th>Quantity</th> </tr> </thead> <tbody> <tr> <td>Factory installed</td> <td>Lubricating oil</td> <td>As required</td> </tr> </tbody> </table>	Installation	Trade name	Quantity	Factory installed	Lubricating oil	As required	
Installation	Trade name	Quantity						
Factory installed	Lubricating oil	As required						
2	<p>Gear</p> <ul style="list-style-type: none"> Lubricated with oil. Lubrication will last for the designed working period of the hoist. <table border="1"> <thead> <tr> <th>Installation</th> <th>Trade name</th> <th>Quantity</th> </tr> </thead> <tbody> <tr> <td>Factory installed</td> <td>Gear oil</td> <td>Lubricated for the designed working period of the hoist</td> </tr> </tbody> </table>	Installation	Trade name	Quantity	Factory installed	Gear oil	Lubricated for the designed working period of the hoist	
Installation	Trade name	Quantity						
Factory installed	Gear oil	Lubricated for the designed working period of the hoist						

8.6 Approaching Theoretical Calculated Lifetime

8.6.1 Special Assessment

A special assessment is a thorough examination and evaluation of the product carried out by authorized service personnel or experienced service man authorized by the manufacturer or manufacturer's representative in accordance with the ISO 12482-1 standard. It is done when the product approaches the end of each SWP, typically when 20% of the SWP remains. Any general overhaul requirements stated in the special assessment report must be carried out before further use of the product.

8.6.2 General Overhaul



WARNING

When the Safe Working Period (SWP) of the hoist is exhausted, the hoist may only be used after a GO has been conducted. Usage of a defective hoist can result in serious damage, injury or death.

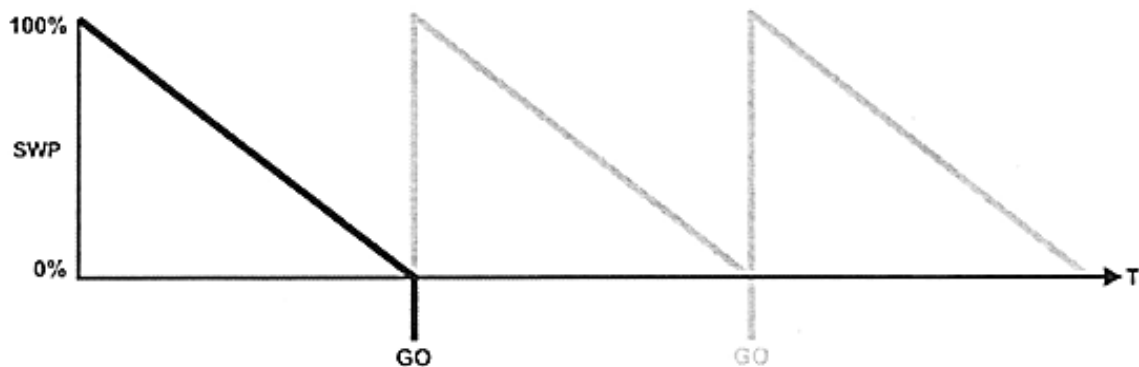

SWP= Safe Working Period
GO = General Overhaul
T = Time

Once the SWP% of the hoisting machinery reaches zero, the hoisting machinery has exhausted its theoretical lifetime. The probability of a defect in the product is therefore higher and operating safety is jeopardized. At the end of the SWP, a thorough General Overhaul (GO) must be conducted. Afterwards the product will then be assigned a new SWP, provided that it is safe to continue operation. At the start of each period the SWP is 100% and, at the end, the SWP is 0%.

Only authorized service personnel or an experienced service man authorized by the manufacturer or manufacturer's representative may conduct a GO. The components that have an impact on product's lifetime are inspected and critical components are replaced. A new theoretical SWP is given after completion of a GO. The same hoisting machinery can undergo no more than two GOs before it must be completely replaced

8.7 Returning the Product to Use after a Long Period Out of Service



Note: These actions should also be carried out if the product has been exposed to extreme weather conditions.

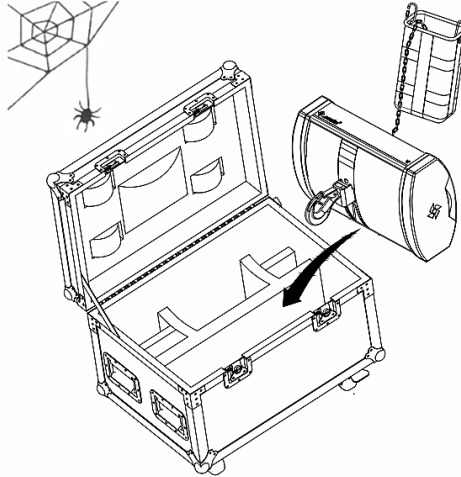

For storing conditions refer to the Appendix “Transportation and storing the product”.

When taking the product into use after a long period, checks must be done according to chapter “Checks to be done before every working shift”.

Before returning the product to use, carry out the relevant checks listed in the “General safety”, “Safety during installation and disassembly” and “Safety during maintenance”.

Further, for complete re-commissioning instructions, refer to chapter “Commissioning”.

8.8 Frame

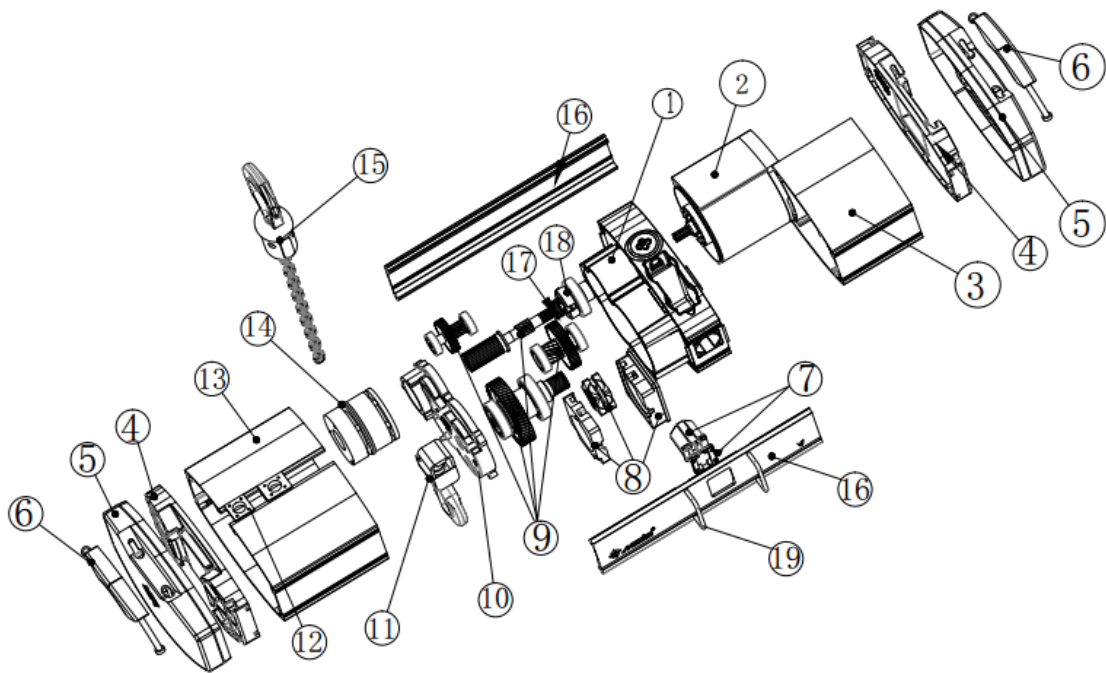

ITEM	DESCRIPTION	QTY
1	FRAME	1
2	MOTOR	1
3	MOTOR HOUSING	1
4	COVERS SET/SIDE MOTOR	1
4	COVERS SET/SIDE BRAKE	1
5	RUBBER SET / SIDE MOTOR	1
5	RUBBER SET/SIDE BRAKE	1
6	CRANE HANDLE	2
7	GUARD CHAIN	1
8	THE CHAIN GUIDE DEVICE	1
9	GEAR PINIONS SET	4
10	GEAR CASE COVER	1
11	CRANE HOOK	1
12	CABLE FIXING SEAT	5
13	BRAKE HOUSING	1
14	ELECTROMAGNETIC BRAKE	2
15	THE CHAIN HOOK	1
16	THE SIDE PANEL	2
17	SAUCER REED	8
18	COUPLING SIDE BRAKE	1
19	CHAIN BUCKET HANDLES	2

8.9 Motor

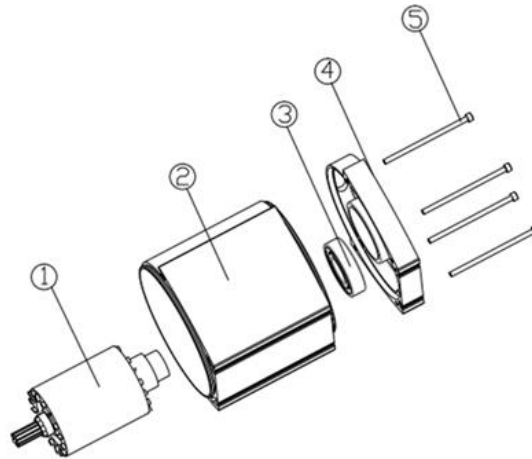

ITEM	DESCRIPTION	QTY
1	MOTOR ROTOR	1
2	MOTOR STATOR	1
3	BEARING COMBINATION	1
4	SEAL SLEEVE	1
5	SCREW	4

9 DISMANTLING

9.1 Dismantling the Product

The product will need to be dismantled at the end of its life or if it must be moved to a new location.

Strict safety precautions shall be followed when dismantling the product. For example, when working at heights, fall protection procedures must be followed. Only experienced service personnel are permitted to dismantle the product.

The owner shall nominate a person to be responsible for the dismantling process. This person shall give instructions and monitor the process.

All controls must be placed in the OFF position, safety switches must be opened and the main isolator switch must be turned off. The product must be electrically isolated before dismantling commences.

Make sure that all personnel involved are aware that the product will be dismantled before dismantling commences.

The owner must prevent unauthorized persons and bystanders from walking on or below the work site. Ensure that the secured area is spacious enough to prevent injuries which could occur as a result of falling components or tools.

Only use safe tools and machinery for dismantling.

Make sure that removed fastenings and components will not fall.

Pay attention to the environmental conditions. For example, do not disassemble the product if the prevailing weather could compromise safety.

The disassembly sequence is completed in the reverse order to the assembly sequence. Refer to installation/assembly instructions for correct sequence.

After the product has been dismantled, the owner or person responsible for the dismantling can return the working area back to normal use.



Note: Remove all greases and oils from the hoist before discarding it.

9.2 Disposal of Waste Material

Waste material from installation, maintenance or dismantling shall be handled and disposed of according to local regulations. From the sustainability point of view, the preferred waste handling methods are reuse, recycle as material, recycle to energy, and as a final resort, safe disposal.

As waste regulations and types of recovery and disposal methods vary so much regionally, no general detailed guidance can be given. The chart below gives example of manufacturer's proposals for adequate waste handling methods.

NOTICE	Use always licensed recycling companies
---------------	--

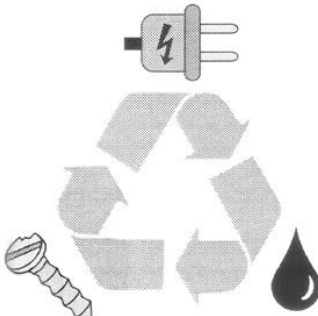
1	Metals should be recycled.	
2	Electronics and electromechanical components should be collected separately and recycled. Some electrical parts may be treated as hazardous waste, e.g. standard fluorescent lamps contain mercury.	
3	Batteries and other energy storage components may contain hazardous substances. These items should be collected separately and recycled according to local regulations.	
4	Plastics should be either recycled as material or used for energy recovery or landfilled. PVC plastic should be recycled according to local regulations.	
5	Chemicals , like oil, grease and other liquids shall never be spilled onto the ground, soil or sewage. Waste oil and grease shall be stored in containers indicated for the purpose. More detailed information of chemical handling as waste can be found in the chemical's Safety Data Sheet that is available from manufacturer of the chemical.	
6	Packing materials , like plastics, wood and cardboard, should be reused or recycled as material or to energy.	

10 TECHNICAL DATA

10.1 Technical Features

The basic technical specifications can be found on the hoist's data plate. In this chapter you can see more extensive technical specifications.

Technical data

Load	1000 KG
Height of lift	25 M
Power supply	3-phase (EL17) / 400 V (ELE01) / 50 HZ (ELE03)
Hoisting speed	4 m/min (SPD03)

10.2 Tightening torques

The recommended tightening torques for steel are presented in the following table

NOTICE

Values shown in the table are nominal values. In practice, for example for lubricated bolts, you need to use higher torques.

Bolt size	Tightening torque			
	Strength 8.8		Strength 10.9	
	[N m]	[Ft lb]	[N m]	[Ft lb]
M4	2.7	2.0	4.0	2.9
M5	5.4	4.0	7.9	5.8
M6	9.3	6.8	14	10.3
M8	23	17.0	33	24
M10	45	33.0	66	48.5
M12	77	56.6	115	84.6
M14	125	92	180	132
M16	190	140	280	206
M18	275	202	390	287
M20	385	283	550	404
M22	530	390	750	552
M24	660	485	950	699
M27	980	721	1400	1030
M30	1350	993	1900	1398



Note: It is recommended that self-locking nuts are always replaced when removed. Self locking nuts can be reused no more than 5 times.

APPENDIX: INSPECTING CHAIN WEAR

Measuring Wear on the Chain



Note: The chain should be inspected regularly for wear, rust and corrosion.

1	<p>VISUAL CHECKS</p> <p>Examine visually for gouges, nicks, weld splatter, corrosion or distorted links and slacken chain. Check bearing surfaces between links for wear.</p> <p>A chain with excessively pitted, corroded, nicked, gouged, twisted or worn links should be replaced with a factory approved chain.</p>																	
2	<p>Measure link thickness (d) Measure the dimension (d) at several points of the chain and calculate the dimension (d_m).</p> $d_m = (d_1 + d_2) / 2 < 0.9 * d_n$ <p>d_m = nominal t = pitch Criteria:</p> <table border="1" data-bbox="220 1041 938 1294"> <thead> <tr> <th colspan="4">Chain size</th> </tr> <tr> <th>d*t</th> <th>4x11</th> <th>5x14</th> <th>7x20</th> </tr> </thead> <tbody> <tr> <td>d_n</td> <td>4</td> <td>5</td> <td>7</td> </tr> <tr> <td>d_m max [mm] (in)</td> <td>3.6 (0.142)</td> <td>4.5 (0.177)</td> <td>6.3 (0.248)</td> </tr> </tbody> </table>	Chain size				d*t	4x11	5x14	7x20	d _n	4	5	7	d _m max [mm] (in)	3.6 (0.142)	4.5 (0.177)	6.3 (0.248)	
Chain size																		
d*t	4x11	5x14	7x20															
d _n	4	5	7															
d _m max [mm] (in)	3.6 (0.142)	4.5 (0.177)	6.3 (0.248)															



Note: Use only a "knife-edge" caliper to eliminate the possibility of false reading by not measuring full pitch length.

	<p>Measure elongation (P)</p> <p>Measure (P), the pitch over 11 links, at different regions of the chain.</p> <p>Criteria :</p> <table border="1" data-bbox="220 1563 938 1816"> <thead> <tr> <th colspan="4">Chain size</th> </tr> <tr> <th>d*t</th> <th>4x11</th> <th>5x14</th> <th>7x20</th> </tr> </thead> <tbody> <tr> <td>d_n</td> <td>4</td> <td>5</td> <td>7</td> </tr> <tr> <td>d_m max [mm] (in)</td> <td>123.42 (4.859)</td> <td>157.08 (6.184)</td> <td>224.4 (8.835)</td> </tr> </tbody> </table> <p>*NOTE: 2% elongation as per ISO 7592.</p>	Chain size				d*t	4x11	5x14	7x20	d _n	4	5	7	d _m max [mm] (in)	123.42 (4.859)	157.08 (6.184)	224.4 (8.835)	
Chain size																		
d*t	4x11	5x14	7x20															
d _n	4	5	7															
d _m max [mm] (in)	123.42 (4.859)	157.08 (6.184)	224.4 (8.835)															



Note: If these limits are exceeded, the chain must be replaced immediately. In this case, wear on the guide chain and chain sprocket should also be checked and they should be replaced if necessary.



Note: If a single link is defective in any way whatsoever, the chain must be replaced.

 CAUTION	Do not assume that a load chain is safe because it measures below replacement points given herein. Other factors, such as those mentioned in visual checks above, may render the chain unsafe or ready for replacement long before elongation replacement is necessary.
---	--

 CAUTION	A repetitive stop and start at the same point of the chain will create a more severe wear on the 2-3 links in the chain sprocket.
---	--

APPENDIX: INSPECTING THE HOOK OPENING

Measuring Wear on the Hook

Wear on the suspension and lifting hooks should be checked regularly. Damaged safety catches should be replaced immediately.

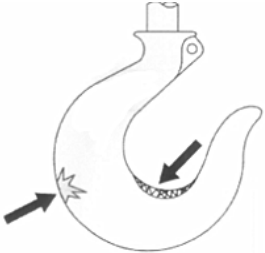
1	<p>Visual checks</p> <p>Hook surface should be free of significant rust, weld splatter, deep nicks, or gouges. Check for damage from chemicals, deformation or cracks or twisted more than 10 degrees from the plane of the unbent hook, or opening, allowing the hook latch to bypass hook tip.</p>	
----------	---	---

 <p>WARNING</p>	<p>Any hook that is twisted or has excessive throat opening indicates abuse or overloading of the hoist. Other load bearing components of the hoist should be inspected for damage..</p>
---	---

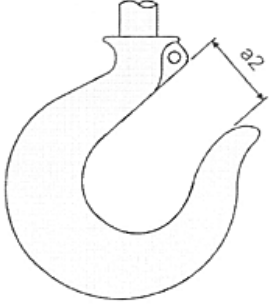
1	<p>Measure bottom hook opening (a2)</p> <p>If the maximum dimension (a2) on the lifting hook is greater than the initial dimension by more than 15 %, the hook should be replaced.</p> <p>Criteria:</p> <table border="1" style="width: 100%;"> <thead> <tr> <th style="width: 30%;">Hook size</th> <th style="width: 70%;">a2 max [mm] (in)</th> </tr> </thead> <tbody> <tr> <td style="text-align: center;">012</td> <td style="text-align: center;">25.3(0.996)</td> </tr> <tr> <td style="text-align: center;">020</td> <td style="text-align: center;">28.75(1.132)</td> </tr> <tr> <td style="text-align: center;">04</td> <td style="text-align: center;">34.5(1.358)</td> </tr> <tr> <td style="text-align: center;">08</td> <td style="text-align: center;">41.4(1.630)</td> </tr> </tbody> </table>	Hook size	a2 max [mm] (in)	012	25.3(0.996)	020	28.75(1.132)	04	34.5(1.358)	08	41.4(1.630)	
Hook size	a2 max [mm] (in)											
012	25.3(0.996)											
020	28.75(1.132)											
04	34.5(1.358)											
08	41.4(1.630)											

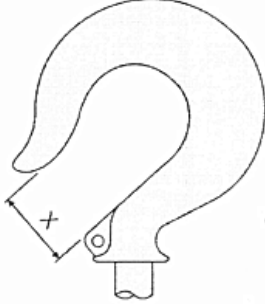
2	<p>Measure top hook opening (X)</p> <p>If the maximum dimension (X) on the suspension hook is greater than the initial dimension by more than 15 %, the hook should be replaced.</p> <p>Criteria:</p> <table border="1" style="width: 100%;"> <thead> <tr> <th style="width: 30%;">Hook size</th> <th style="width: 70%;">X max [mm] (in)</th> </tr> </thead> <tbody> <tr> <td style="text-align: center;">012</td> <td style="text-align: center;">25.3(0.996)</td> </tr> <tr> <td style="text-align: center;">020</td> <td style="text-align: center;">28.75(1.132)</td> </tr> <tr> <td style="text-align: center;">04</td> <td style="text-align: center;">34.5(1.358)</td> </tr> <tr> <td style="text-align: center;">08</td> <td style="text-align: center;">41.4(1.630)</td> </tr> </tbody> </table>	Hook size	X max [mm] (in)	012	25.3(0.996)	020	28.75(1.132)	04	34.5(1.358)	08	41.4(1.630)	
Hook size	X max [mm] (in)											
012	25.3(0.996)											
020	28.75(1.132)											
04	34.5(1.358)											
08	41.4(1.630)											



Note: The hook dimensions are nominal since they are not controlled to a tolerance. The reference measurement of throat opening (a2) should be taken when the hook is new.

APPENDIX: TROUBLESHOOTING (3 PHASES)

Problem	Cause	Solution
The chain hoist does not work	The emergency stop button is activated	Deactivate the emergency stop button
	Triggered fuse	Replace the fuse
	Temperature control (optional) activated	Allow for cooling
	Contactors terminal screws loose	Tighten the screws
	Main switch is off	Turn the main switch on
The load cannot be lifted	Overload	Reduce the load
	Slipping clutch worn or incorrectly adjusted	Replace or adjust the clutch
Braking path of more than 10 cm (3.93 in)	Brake lining is worn	Replace the brake and replace the brake components if necessary
Abnormal noises when the load is being moved	The chain components are not lubricated	Lubricate the components
	The chain is worn	Replace the chain
	The sprocket or chain guide is worn	Replace the sprocket or chain guide
	Idler sprocket is worn	Replace the sprocket
	A supply phase is missing	Check the connection of the three phases

APPENDIX: TRANSPORTING AND STORING

THE PRODUCT

Transportation Instructions

- Products shall be loaded and transported with caution and using appropriate methods, making proper preparations and taking appropriate caution.
- Loading or transporting products is prohibited if your alertness or working ability is impaired, for example by medication, illness or injury.
- The load must be securely fastened during transportation.

During loading and transportation, the product package shall be orientated in the same way as when it was received from the manufacturer Inverting the product could cause lubricants to leak.

Storage Instructions

- The product should be stored at room temperature.
- The product shall be protected from dust and humidity.
- The product shall be stored the same way up as it would be during normal operation.
- The product shall be protected from adverse weather conditions, if stored outdoors.

 CAUTION	Defects or faults which are due to improper transportation or storage are not covered by the product's warranty
--	--

 CAUTION	Essential parts of the product can become damaged if stored improperly
--	---

APPENDIX: SAFE WORKING PERIOD (SWP)

CALCULATION

The end of the Safe Working Period (SWP) must be calculated in accordance with the ISO 12482-1 standard during each recurring inspection and service. If the component does not have a condition monitoring unit, use the following method to calculate the remaining SWP%.



Note: If a condition monitoring unit is fitted, it performs the SWP calculation and displays the remaining SWP% automatically.



Note: The condition monitoring unit can be retrofitted as a modernization to enhance safety. Contact your supplier for more details.



Note: The values used in each SWP calculation, as well as the result and date, must be carefully recorded in the log book. Each SWP calculation requires the use of figures recorded during previous calculations.

Step 1: Calculate the motor operating hours (running hours) per inspection interval, T_i

Check the following values for this inspection interval:

J = the number of working days during the inspection interval [days]

H = the average hoisting height [m]

N = the average number of work cycles per hour [cycles/h]

T = the average daily working time [h]

V = the maximum hoisting speed [m/min] (as shown on the data plate)

Use the following formula to calculate T_i , the motor operating hours (total lifting time) per inspection interval:

$$T_i = \frac{2 * H * N * T * J}{V * 60}$$

For example, if we use:

$J = 180$ [days], $H = 5$ [m], $N = 20$ [cycles/h], $T = 12$ [h], $V = 5$ [m/min]

$$T_i = \frac{2 * 5 * 20 * 12 * 180}{5 * 60} = 1440$$

Step 2: Calculate the actual load spectrum factor per inspection interval, K_{mi}

1. Divide the total lifting time in proportion to the actual load spectrum during the inspection interval. For example, if the product has lifted full loads (100%) for half of the time and no load (0%) for half of the time then record 50 for each of these in the "Lifting time %," column of the table below.

Load %	Lifting time %		Factor k ³		Load spectrum factor	
100%		*	1	=		
80%		*	0.51	=		
60%		*	0.22	=		
40%		*	0.06	=		
20%		*	0.01	=		
0%		*	0	=		
Total:	100%	*	Sum:			
					Divide by 100:	Sum /100 =
					Load spectrum factor, K _{mi} :	

- The sum of the figures in the “Lifting time %” column must always be 100.
- Multiply each entry in the “Lifting time %” column by the multiplier in the “Factor k3” column. Write the results in the “Load spectrum factor” column.
- Add up the numbers in the “Load spectrum factor” column and record the result of this sum.
- Divide the sum of the “Load spectrum factor” column by 100 to get the K_{mi}

For example, if we use: 100% load for 10% of the time, 40% load for 30% of the time and 20% load for 60% of the time:

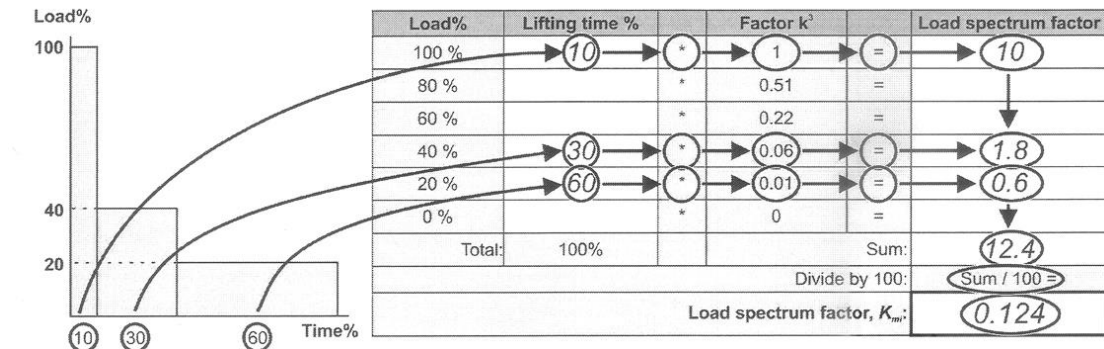

Step 3: Calculate the partial duration of service, S_i

Use T_i and K_{mi} in the following formula to calculate S_i [hours]

Select the value of X, from the table below.

$$S_i = X * K_{mi} * T_i$$

Product	Value of X
With counter and log book	1.2
With log book	1.4
Without counter, log book or CMS	1.5

Record the value of S_i in the log book. This value will be needed for future SWP calculations.

For example, if we use: X=1.2, K_{mi}=0.124 and T_i =1440:

$$S_i = 1.2 * 0.124 * 1440 = 214.272$$

Step 4: Calculate the actual duration of service, S

Add together each of the S_i / partial duration of service values gathered from this and previous inspection intervals since the start of the safe working period.

The earlier S values (S₁...S_i) can be read from the log book.

$$S = S_1 + S_2 + \dots + S_i$$

For example, if we use $S_1 = 215.468$, $S_2 = 210.26$, $S_3 (S_i) = 214.272$:

$$S = 215.468 + 210.26 + 214.272 = 640$$

Step 5: Calculate the SWP% and remaining service life

Check the hoist operating group which can be found on the hoist's rating plate.

In the appropriate column of the following table, find the number closest to S. The two final columns on the same row will tell you the remaining SWP% and the estimated remaining service life.

Hoist operating group marked on hoist's rating plate						SWP%	Estimated remaining service life [years]
M3(1Bm)	M4(1Am)	M5(2m)	M6(3m)	M7(4m)	M8(5m)		
Actual duration of service, S [h]							
0	0	0	0	0	0	100%	10
40	80	160	320	630	1250	90%	9
80	160	320	640	1260	2500	80%	8
120	240	480	960	1890	3750	70%	7
160	320	640	1280	2520	5000	60%	6
200	400	800	1600	3150	6250	50%	5
240	480	960	1920	3790	7500	40%	4
280	560	1120	2240	4410	8750	30%	3
320	640	1280	2560	5040	10000	20%	2
360	720	1440	2880	5670	11250	10%	1
400	800	1600	3200	6300	12500	0%	0

Record the value of SWP% in the log book.

For example, if we use $S = 640$, Hoist duty group = M5 (2m) then SWP%=60%:

Hoist operating group marked on hoist's rating plate						SWP%	Estimated remaining service life [years]
M3(1Bm)	M4(1Am)	M5(2m)	M6(3m)	M7(4m)	M8(5m)		
Actual duration of service, S [h]							
0	0	0	0	0	0	100%	10
40	80	160	320	630	1250	90%	9
80	160	320	640	1260	2500	80%	8
120	240	480	960	1890	3750	70%	7
160	320	640	1280	2520	5000	60%	6
200	400	800	1600	3150	6250	50%	5
240	480	960	1920	3790	7500	40%	4
280	560	1120	2240	4410	8750	30%	3
320	640	1280	2560	5040	10000	20%	2
360	720	1440	2880	5670	11250	10%	1
400	800	1600	3200	6300	12500	0%	0

When SWP% reaches zero, a General Overhaul (GO) must be conducted. Refer to chapter 'General Overhaul (GO)'

ANNEX, ANSI HAND SIGNALS

These are the most commonly used **ANSI** hand signals. A copy of the hand signals should be placed close to the operator's station for reference.

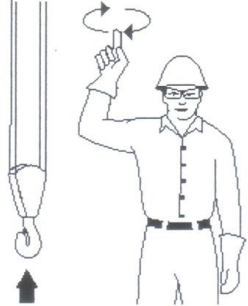
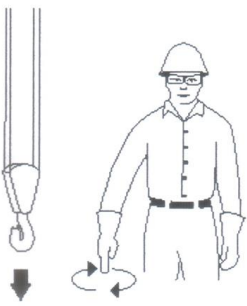
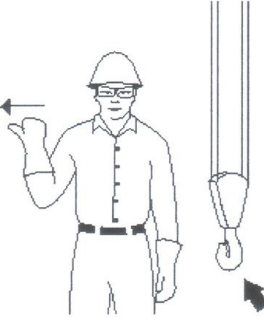
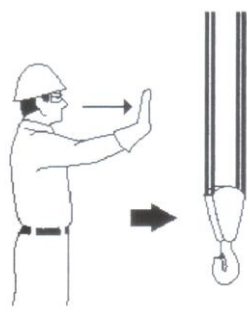
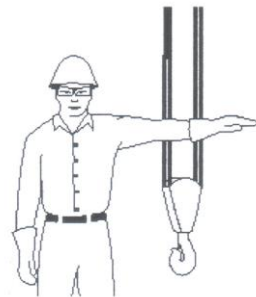
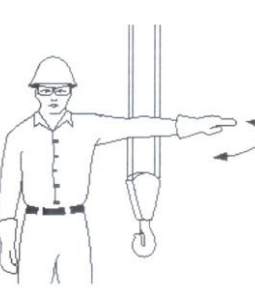
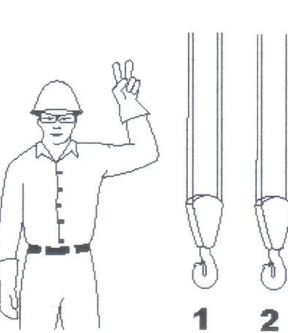
Description	ANSI hand signal	Description	ANSI hand signal
<p>Hoist</p> <p>With forearm vertical, and forefinger pointing up, move hand in a small horizontal circle.</p>		<p>Lower</p> <p>With arm extended downward, forefinger pointing down, move hand in a small horizontal circle.</p>	
<p>Trolley travel</p> <p>Palm up, fingers closed, thumb pointing in direction of motion, jerk hand horizontally.</p>		<p>Bridge travel</p> <p>Arm extended forward, hand open and slightly raised, make pushing motion in direction of travel.</p>	
<p>Stop</p> <p>Arm extended, palm down and hold position rigidly.</p>		<p>Emergency stop</p> <p>Arm extended, palm down, move hand rapidly right and left.</p>	
<p>Multiple trolleys</p> <p>Hold up one finger for block marked "1" and two fingers for block marked "2". Regular signals follow.</p>		<p>Move slowly</p> <p>Use one hand to give any motion signal and place the other hand motionless in front of hand giving the motion signal. (Hoist slowly as shown in example.)</p>	