

Interactive Flat Panel

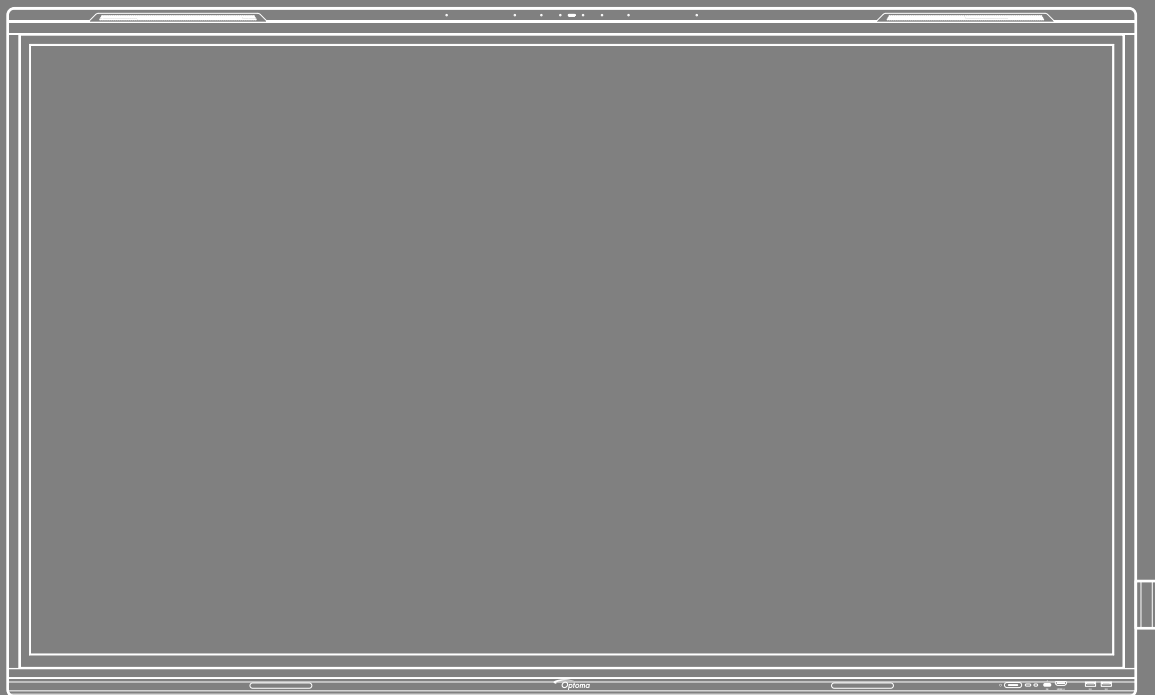

TABLE OF CONTENTS

SAFETY	5
Safety Instructions	5
Copyright	6
Disclaimer	6
Trademark Recognition	6
FCC Statement	6
FCC Warning	6
Declaration of Conformity for EU Countries	7
WEEE	7
ENERGY STAR	7
Low Blue Light and Eye Health	7
What is Low Blue Light Technology?	7
Calculating Breaks	7
Looking at Distant Objects	7
How to Exercise Your Eyes?	7
INTRODUCTION	8
Package Contents	8
Standard Accessories	8
Optional Accessories	9
Product Overview	10
Front View	10
Rear View	11
Remote Control	12
SETUP AND INSTALLATION	14
Wall Mounting Installation	14
Wall Mount Specifications	14
Installing an External Mini Computer	17
Stand Mounting Installation (Optional)	18
Using the Remote Control	21
Installing/Replacing the Remote Control Batteries	21
Remote Control Operating Range	22
Connections	23
Connecting to Power	23
Connecting External Devices	23
USING THE DEVICE	31
Turning the Power On/Off	31
Setup Wizard	32

BASIC OPERATIONS..... 33

Home Screen Overview.....	33
OSD Menu.....	34
Shortcut Menu.....	35
Configuring the Image Settings.....	38
Configuring the Display Settings.....	39
Configuring Audio Settings.....	40
Viewing Device Information.....	41
Android Settings Menu.....	42
Personalizing the System.....	42
Configuring Network Settings.....	47
Configuring Device Settings.....	49
Configuring Security Settings.....	51
Configuring System Settings.....	54
Side Toolbar.....	58
Viewing Recent Tasks.....	59
Annotation App.....	60
Airshare.....	61
Screen Capture Tool.....	66
More Tools.....	67
Floating Menu Toolbar.....	69
More Home Screen Features.....	70
Quick Settings Panel.....	71
Manage the Source Shortcuts.....	72
View the Sensor Panel.....	72

USING THE APPS 73

Whiteboard.....	74
Display Share.....	84
Supported Operating Systems for Casting.....	84
Proprietary Sharing.....	84
Mobile Device.....	85
Computer.....	87
Display Share Configuration.....	90
File Manager.....	92
Managing Files.....	92
Cloud Storage.....	94
Playing Multimedia Files.....	96
Browser.....	101
Keeper.....	102
Optoma Management Suite (OMS).....	103

ADDITIONAL INFORMATION 105

Dimensions.....	105
65-inch.....	105
75-inch.....	106
86-inch.....	107

Supported Timing List.....	108
RS232 Protocol Function List.....	110
RS232 Pin Assignments.....	110
RS232 RJ45 Control Connection	110
SET Command.....	111
GET Command	114
LED Indicator.....	116
Troubleshooting.....	117
Maintenance.....	118
Cleaning the Screen.....	118
Clean the Front Frame	118
Optoma Global Offices	119

SAFETY

Please follow all warnings, precautions and maintenance as recommended in this user manual.

Safety Instructions

- Only use Optoma-approved attachments/accessories.
- Do not block any ventilation openings. To ensure reliable operation of the device and to protect from overheating, it is recommended that the device be installed in a location and manner that does not block ventilation. Do not put the device in an enclosure such as a book case or a cabinet that restricts air flow.
- Do not use the device near water or moisture. To reduce the risk of fire and/or electric shock, do not expose the device to rain or moisture.
- Do not install near heat sources such as radiators, heaters, stoves or any other apparatus, such as amplifiers, that emits heat.
- Do not let objects or liquids enter the device. They may touch dangerous voltage ports or short out parts that could result in fire or electric shock.
- Do not place the device on an unstable surface. The device may fall over, resulting in injury or damage to the device.
- Do not setup the device in places where it might be subject to vibration or shock.
- Do not use any hard or sharp object to operate the touch screen.
- Do not use the device if it has been physically damaged or abused. Physical damage/abuse would be (but not limited to):
 - The device has been dropped.
 - Power supply cord or plug has been damaged.
 - Liquid has been spilled on the device.
 - The device has been exposed to rain or moisture.
 - Something has fallen into the device or something is loose inside.
- Do not attempt to service the device yourself. Opening or removing covers may expose you to dangerous voltages or other hazards. Please call Optoma before you send the device for repair.
- Disconnect the power plug from AC outlet if the device is not being used for a long period of time.
- Remove the batteries from the remote control before storage. If the batteries are left in the remote for long periods, they may leak.
- Turn off and unplug the power plug from the AC outlet before cleaning the device.
- Use a soft dry cloth to clean the display housing. Do not use abrasive cleaners, waxes or solvents to clean the device.
- See the device enclosure for safety related markings.
- The device should only be repaired by authorized service personnel.

Copyright

This publication, including all photographs, illustrations and software, is protected under international copyright laws, with all rights reserved. Neither this manual, nor any of the material contained herein, may be reproduced without written consent of the author.

© Copyright 2024

Disclaimer

The information in this document is subject to change without notice. The manufacturer makes no representations or warranties with respect to the contents hereof and specifically disclaims any implied warranties of merchantability or fitness for any particular purpose. The manufacturer reserves the right to revise this publication and to make changes from time to time in the content hereof without obligation of the manufacturer to notify any person of such revision or changes.

Trademark Recognition

Kensington is a U.S. registered trademark of ACCO Brand Corporation with issued registrations and pending applications in other countries throughout the world.

HDMI, the HDMI Logo, and High-Definition Multimedia Interface are trademarks or registered trademarks of HDMI Licensing LLC in the United States and other countries.

Google, the Google logo, and Google Drive are trademarks or registered trademarks of Google LLC.

OneDrive is a trademark and brand of Microsoft Corporation.

All other product names used in this manual are the properties of their respective owners and are Acknowledged.

FCC Statement

This equipment has been tested and found to comply with the limits for a Class B digital device, pursuant to part 15 of the FCC Rules. These limits are designed to provide reasonable protection against harmful interference in a residential installation.

This equipment generates, uses and can radiate radio frequency energy and, if not installed and used in accordance with the instructions, may cause harmful interference to radio communications. However, there is no guarantee that interference will not occur in a particular installation. If this equipment does cause harmful interference to radio or television reception, which can be determined by turning the equipment off and on, the user is encouraged to try to correct the interference by one or more of the following measures:

- Reorient or relocate the receiving antenna.
- Increase the separation between the equipment and receiver.
- Connect the equipment into an outlet on a circuit different from that to which the receiver is connected.
- Consult the dealer or an experienced radio/TV technician for help.

FCC Warning

This device complies with Part 15 of the FCC Rules. Operation is subject to the following two conditions:

- (1) this device may not cause harmful interference, and
- (2) this device must accept any interference received, including interference that may cause undesired operation.

Notice: Canadian users

This Class B digital apparatus complies with Canadian CAN ICES-3 (B)/NMB-003 (B).

Remarque à l'intention des utilisateurs canadiens

Cet appareil numérique de la classe B est conforme à la norme NMB-003 du Canada.

Declaration of Conformity for EU Countries

- EMC Directive 2014/30/EU (Including amendments)
- Low Voltage Directive 2014/35/EU

WEEE



Disposal instructions

Do not throw this electronic device into the trash when discarding. To minimize pollution and ensure utmost protection of the global environment, please recycle it.

ENERGY STAR



ENERGY STAR is a U.S. Environmental Protection Agency voluntary program that helps businesses and individuals save money and protect our climate through superior energy efficiency. Products that earn the ENERGY STAR prevent greenhouse gas emissions by meeting strict energy efficiency criteria or requirements set by the U.S. Environmental Protection Agency. The following logo appears on all ENERGY STAR-certified models:

This product qualifies for ENERGY STAR in the “Standard mode” setting and this is the setting in which power savings will be achieved. Changing the Standard mode picture settings or enabling other features will increase power consumption that could exceed the limits necessary to qualify for ENERGY STAR rating. Refer to EnergyStar.gov for more information on Energy Star program.

Low Blue Light and Eye Health

What is Low Blue Light Technology?

Low Blue Light Technology reduces the blue-light component emitted by your product. The harm of blue light to human eyes is mainly manifested in the pathological harm of eyes and the harm of human body rhythm, which lead to myopia, cataract and macular disease.

Low light certification: it is a certification project to evaluate whether the display equipment meets the requirements of photobiosafety and UV free radiation safety.

Note: To meet TUV Rheinland of low blue light certificate, the display setting should be:

- Display Mode is Presentation
- Color Temperature is Standard
- Low Blue Light is 100.

Calculating Breaks

It is recommended to take a 10-minute break every hour of continuous screen use.

Note: Remember to blink your eyes often to keep them healthy and avoid dryness.

Looking at Distant Objects

During breaks, look at distant objects or close your eyes. This helps to relax your ciliary (focusing) muscle and avoids eye strain.

How to Exercise Your Eyes?

1. Hold your pointer finger a few inches away from your eye.
2. Focus on your finger.
3. Slowly move your finger away from your face, holding your focus.
4. Look away for a moment, into the distance.
5. Focus on your outstretched finger and slowly bring it back toward your eye.

INTRODUCTION

Package Contents

Carefully unpack and verify that you have the items listed below under standard accessories. Some of the items under optional accessories may not be available depending on the model, specification and your region of purchase. Please check with your place of purchase. Some accessories may vary from region to region.

The warranty card is only supplied in some specific regions. Please consult your dealer for detailed information.

Standard Accessories

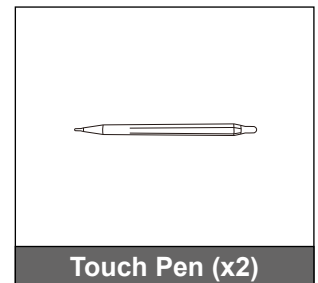
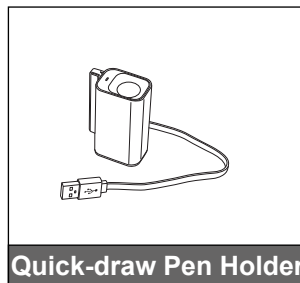
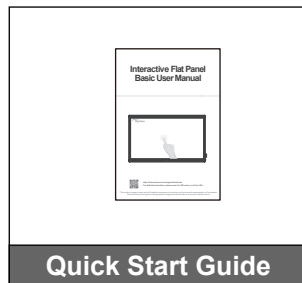
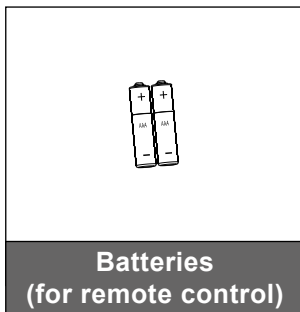
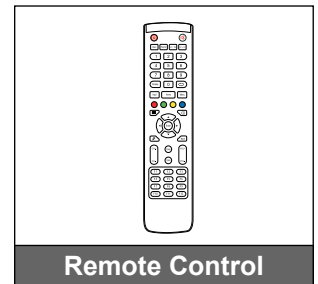
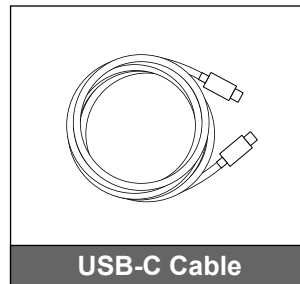
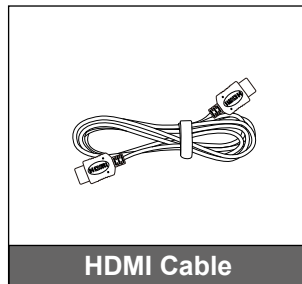
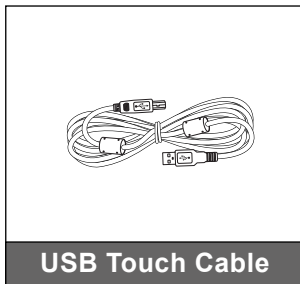
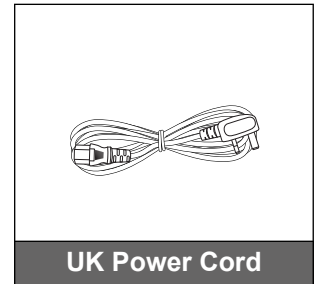
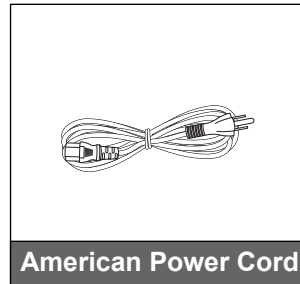
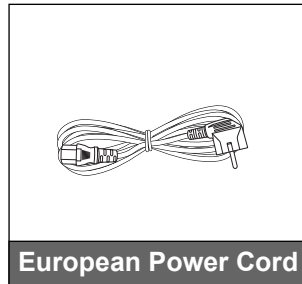
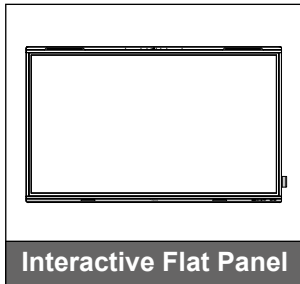

Note: For warranty information, please visit www.optoma.com.

INTRODUCTION

Optional Accessories

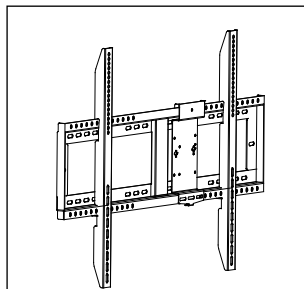

Wall Mount with PC
Vesa Bracket (9060F/
OWMFP01)

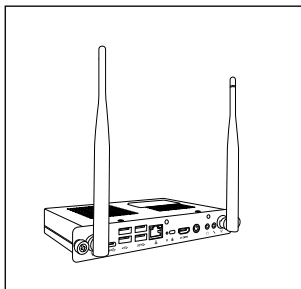

OPS Slot-in PC
(options available)

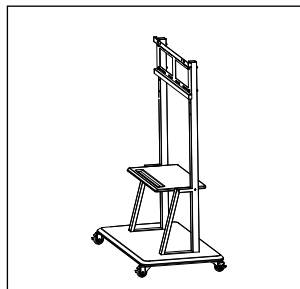

Mobile Stand



Wi-Fi Dongle
(Regional optional)

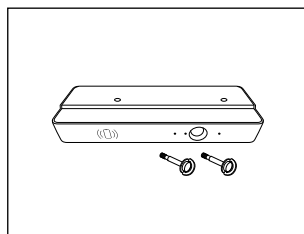

6-in-1 Sensor Box
WL10C

INTRODUCTION

Product Overview

Front View

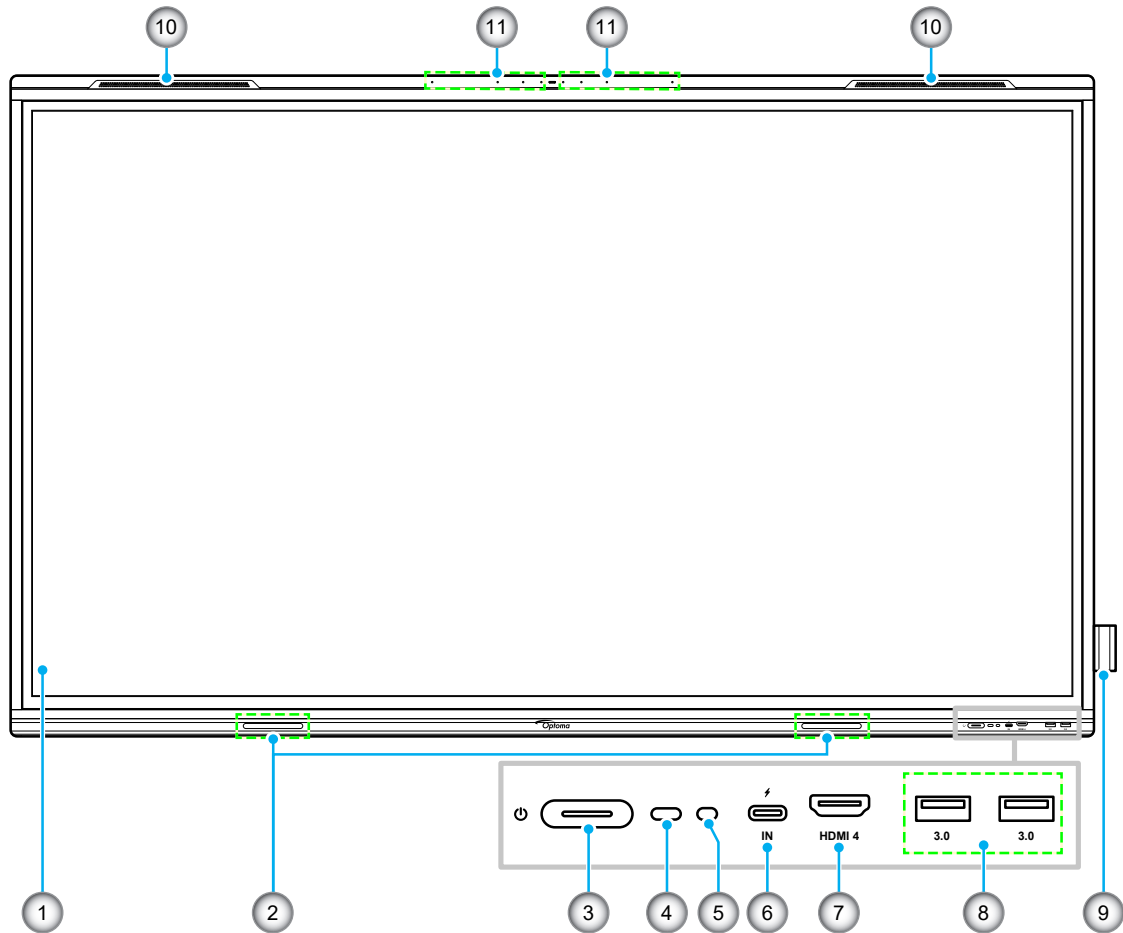

No.	Item
1.	Touch screen
2.	Touch pen placements (x2)
3.	Power button with LED indicator
4.	IR receiver
5.	Light sensor
6.	USB-C In (PD, up to 100W(*))

No.	Item
7.	HDMI 4 In
8.	USB 3.0 In (x2)
9.	Quick-draw pen holder
10.	Speakers (x2)
11.	Microphones

Note: (*) USB-C port supports power delivery up to 100W without OPS. If OPS is installed to the IFF, then the USB-C port supports power delivery 65W.

INTRODUCTION

Rear View

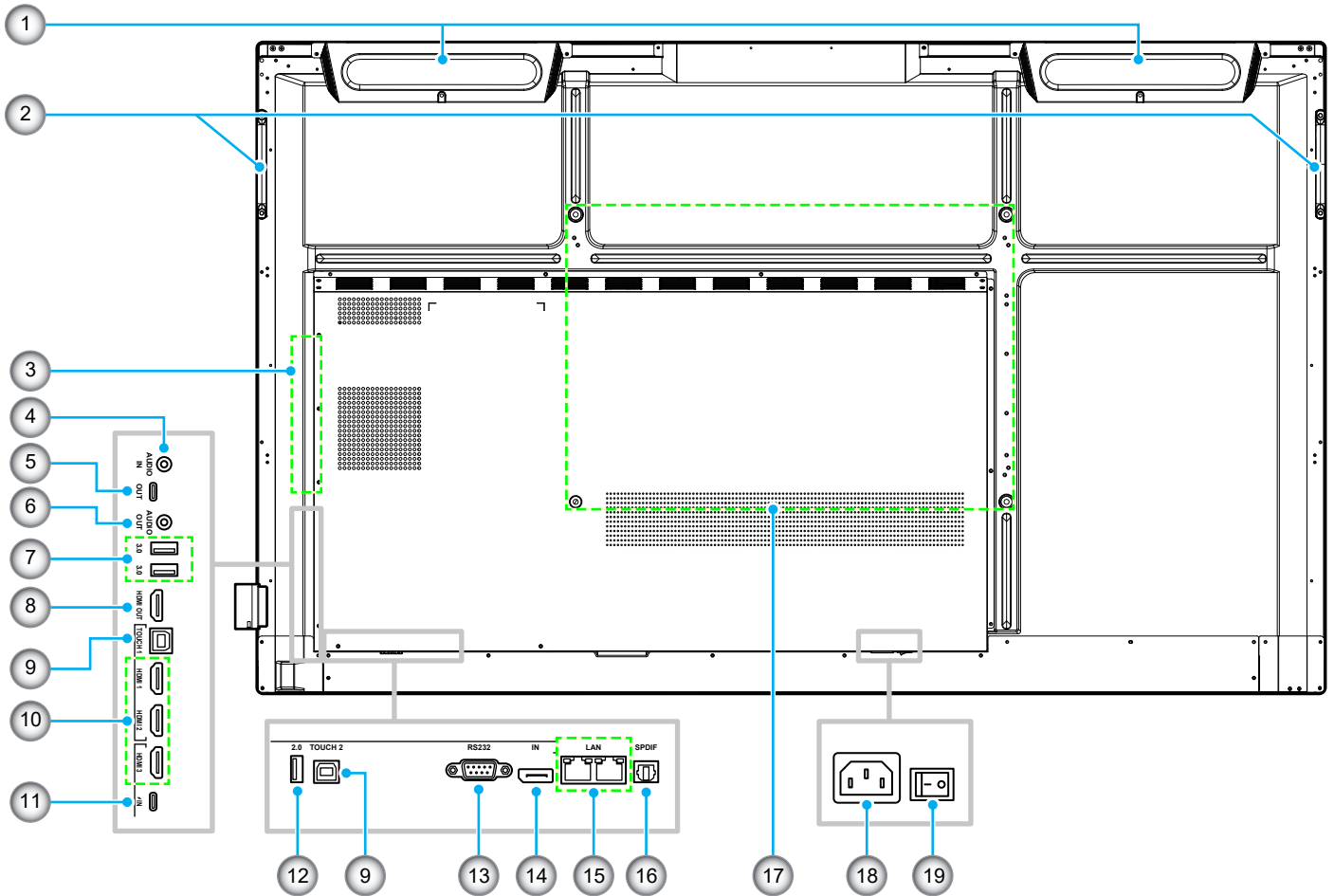

No.	Item
1.	18W subwoofers (x2)
2.	Handles (x2)
3.	OPS slot
4.	Audio In
5.	USB Type-C Out
6.	Audio Out
7.	USB 3.0 In (x2)
8.	HDMI Out
9.	Touch1/Touch2 Out (x2)
10.	HDMI 1/2/3 2.0 In (x3)

No.	Item
11.	USB Type-C In (PD 15W(*))
12.	USB 2.0 In
13.	RS232 In
14.	DisplayPort In
15.	LAN In/Out (x2)
16.	SPDIF Out
17.	Mounting holes for wall mount
18.	AC In
19.	Power switch

Note:

- Side USB 3.0 ports are full channel USB ports. USB ports can be used irrespective of the chosen input source.
- Two HDMI ports support CEC and 1 HDMI In port supports ARC.
- (*) USB type-C port supports DisplayPort 1.2 and power delivery (15W).
- USB 2.0 port is for firmware upgrade or for pen holder connection. If the pen holder is plugged into any of the USB 3.0 ports then the pen holder trigger function can be used only in Android mode.

INTRODUCTION

Remote Control

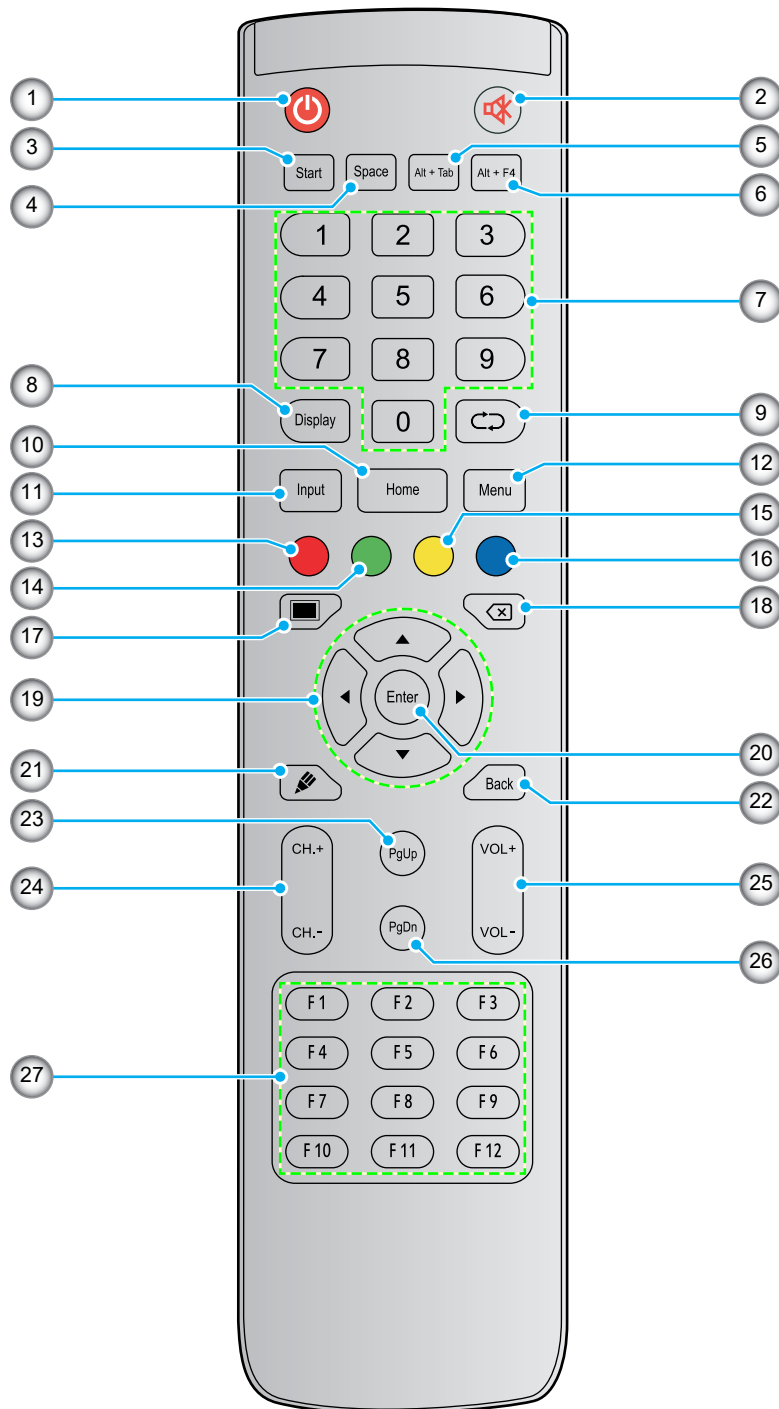

No.	Button	Description
1.	Power (🔌)	Turn on/off the interactive flat panel (IFP).
2.	Mute (🔇)	Turn off the sound temporarily.
3.	Start	Perform the same function as the Windows key on a computer keyboard. (*)
4.	Space	Perform the same function as the Space key on a computer keyboard. (*)
5.	Alt+Tab	Perform the same function as the Alt and Tab keys on a computer keyboard. Pressing both keys, you can switch between all open applications (windows). (*)

INTRODUCTION

No.	Button	Description
6.	Alt+F4	Perform the same function as the Alt and F4 keys on a computer keyboard. Pressing both keys, you can close the current window. (*)
7.	Numeric keys	Numeric input keys
8.	Display	Show the current input source and information.
9.	Repeat (↶)	No function.
10.	Home	Return to the Home screen.
11.	Input	Select the input source.
12.	Menu	Display or hide the OSD menu.
13.	Red (●)	Lock or unlock the Power button (on the IFP) and touch functions.
14.	Green (●)	Lock or unlock the Power button (on the IFP) function.
15.	Yellow (●)	Lock or unlock the touch function.
16.	Blue (●)	Freeze the screen.
17.	AV mute (■)	Turn the screen off/black and stop audio.
18.	Backspace (⌫)	Perform the same function as the Backspace key on a computer keyboard.
19.	Navigation keys (▲▼◀▶)	Select an item or option.
20.	Enter	Confirm the selection.
21.	Whiteboard (✎)	Launch the Whiteboard app.
22.	Back	Return to the previous screen.
23.	PgUp	Perform the same function as the PgUp key on a computer keyboard.
24.	Channel keys	No function.
25.	Volume keys	Adjust the volume level.
26.	PgDn	Perform the same function as the PgDn key on a computer keyboard.
27.	Function keys (F1 ~ F12)	Perform the same function as the F1 ~ F12 function keys on a computer keyboard. (*)

Note: (*) This function only works if OPS with Windows operating system is installed in the OPS slot.

SETUP AND INSTALLATION

Wall Mounting Installation

Use only an Optoma-approved optional wall mount kit (available separately). Kit will include the following items:

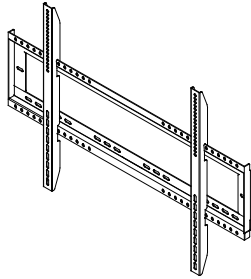

Dual mounting brackets and wall mount



Screw A (x4)



Screw B (x8)



Screw C (x2)



Anchor (x8)



Washer (x8)

Wall Mount Specifications

Model Name	VESA Grid	Screw Type & Length
65-inch	600 x 400 mm	M8*25L
75-inch	800 x 400 mm	M8*25L
86-inch	800 x 600 mm	M8*25L

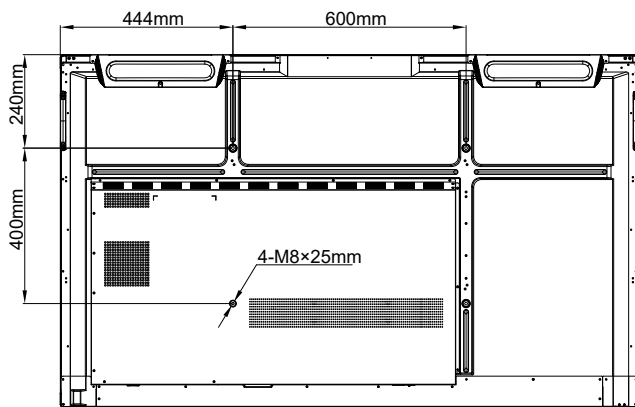

65-inch

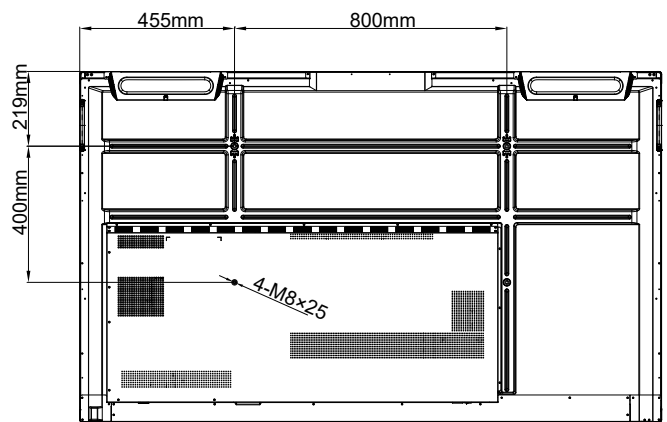

75-inch

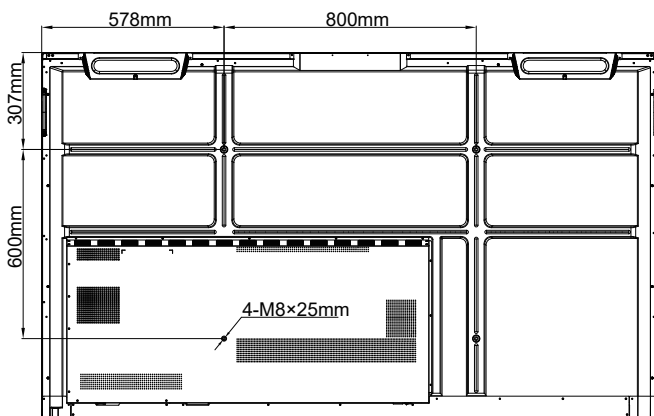

86-inch

SETUP AND INSTALLATION

To mount the IFP on the wall, complete the following steps:

1. Install the dual mounting brackets on the rear of the IFP. Then secure the brackets with four screws (A).

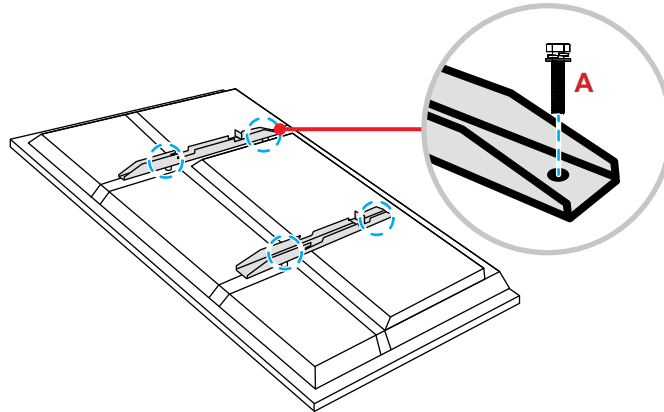

2. Drill eight small holes on the mounting location and insert the anchors into the holes.

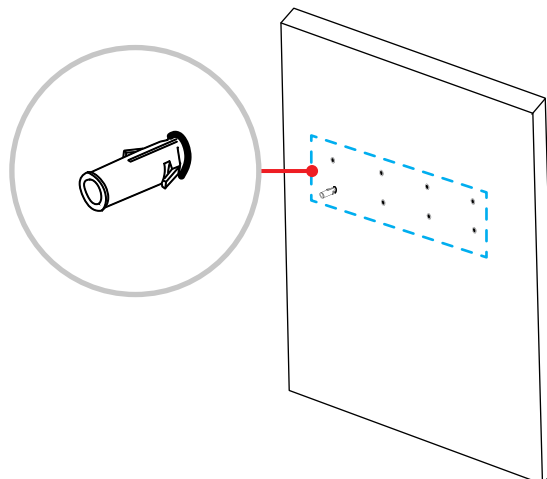

3. Position the wall mount on the wall, then secure the wall mount with eight screws (B) through the washers into the installed anchors on the wall.

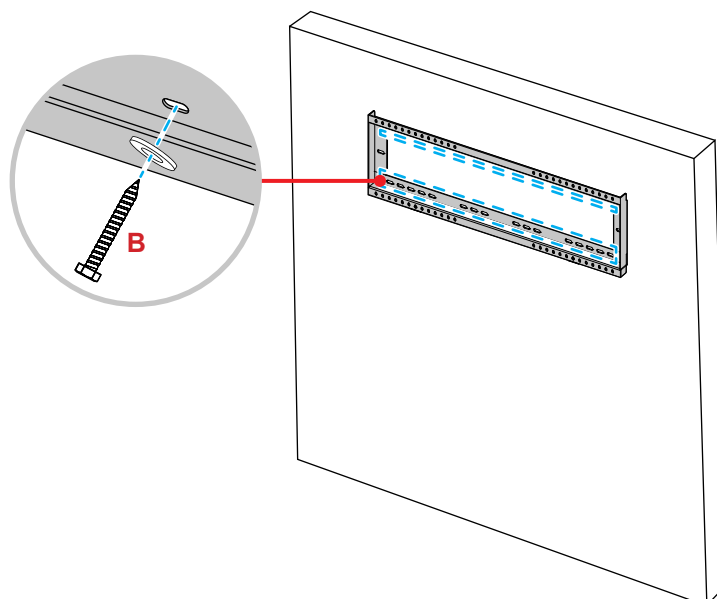

SETUP AND INSTALLATION

4. Align and hook the dual mounting brackets to the wall mount.

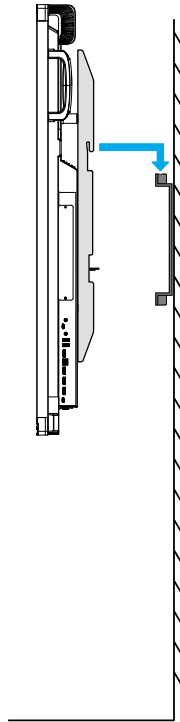

5. Secure the dual mounting brackets and the wall mount with two screws (C).

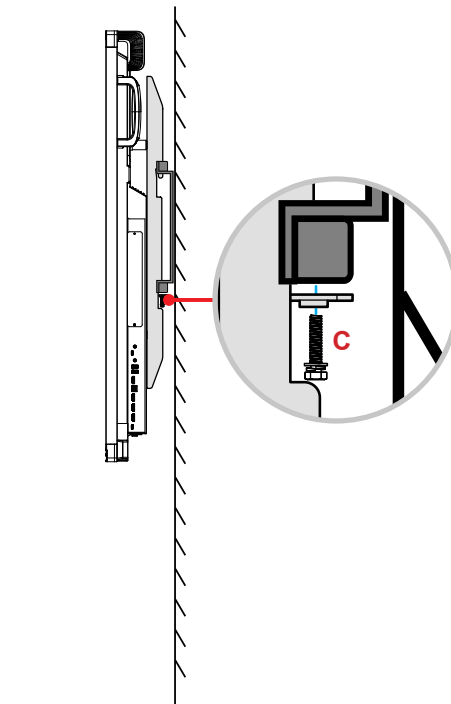

Note:

- *Maximum wall mount kit load capacity: 160kg (352lbs).*
- *The wall mount should be installed into a concrete wall to ensure a secure installation. If concrete wall is not available, we recommend that a stand be used instead. Please refer to page 18.*
- *Screws must be tightly secured; however, to avoid damage to the mounting brackets, wall mount, or IFP, do not overtighten the screws.*
- *The installation should only be performed by qualified technicians. Improper installation may cause the IFP to fall or malfunction.*
- *Please note that damage resulting from incorrect installation will void the warranty.*

SETUP AND INSTALLATION

Installing an External Mini Computer

Install the mini PC bracket on the rear side of the wall mount, then complete one of the following to install the mini computer:

- Install the screws onto the mini computer, then align and hook the mini computer to the mini PC bracket.
- Align and install the mini computer to the mini PC bracket. Then secure it with four screws.

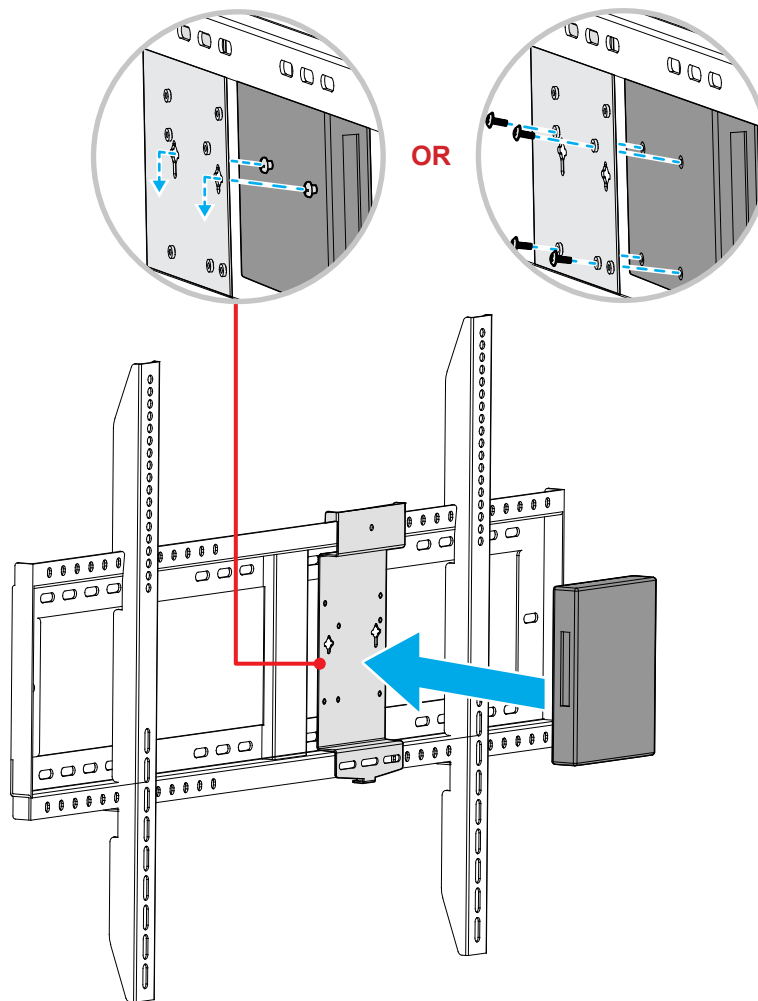

SETUP AND INSTALLATION

Stand Mounting Installation (Optional)

The stand mount kit includes the following items:

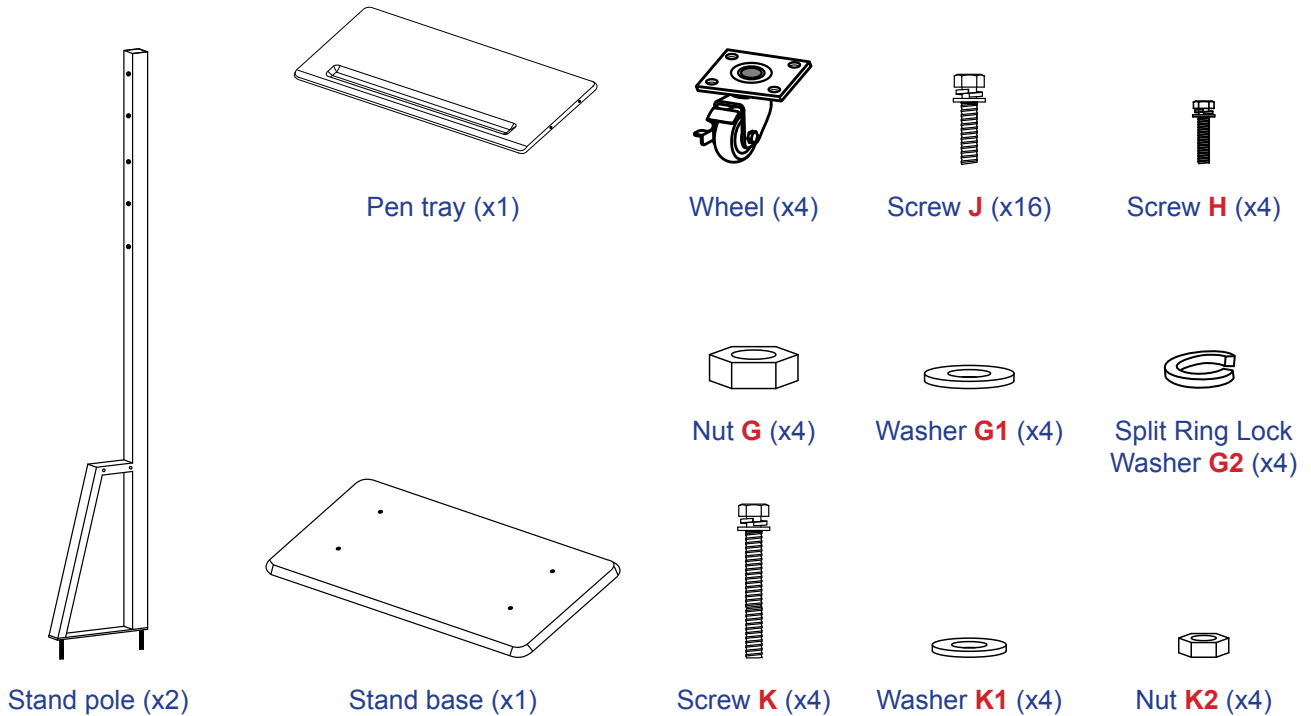

To mount the IFP on the stand, complete the following steps:

1. Install the dual mounting brackets on the rear of the IFP. Then secure the brackets with four screws (A).

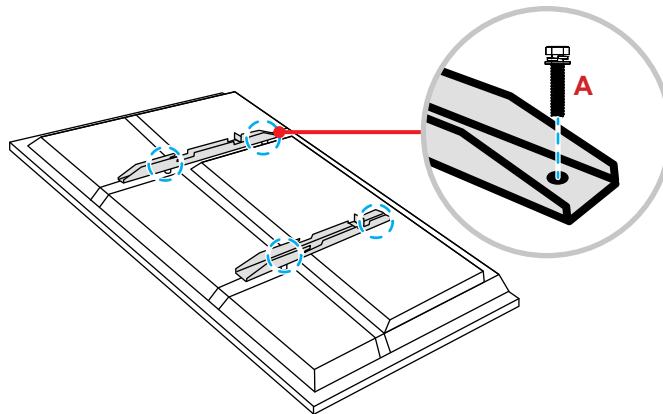

Note: Dual mounting brackets, wall mount, and screws (A) are included in the wall mount kit. Refer to “Wall Mounting Installation” on page 14.

SETUP AND INSTALLATION

2. Flip the stand base so that you can see the screw holes for the wheel, then install the wheel onto its slot and secure it with four screws (**J**).
Repeat the same procedure to install the remaining three wheels.

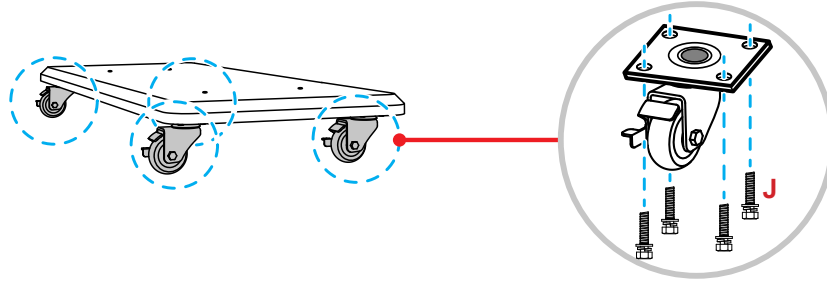

3. Place the stand base on a stable surface, then install the stand pole onto its slot and secure both standoffs with two nuts (**G**) through the washers (**G2** and **G1**).
Repeat the same procedure to install the other stand pole.

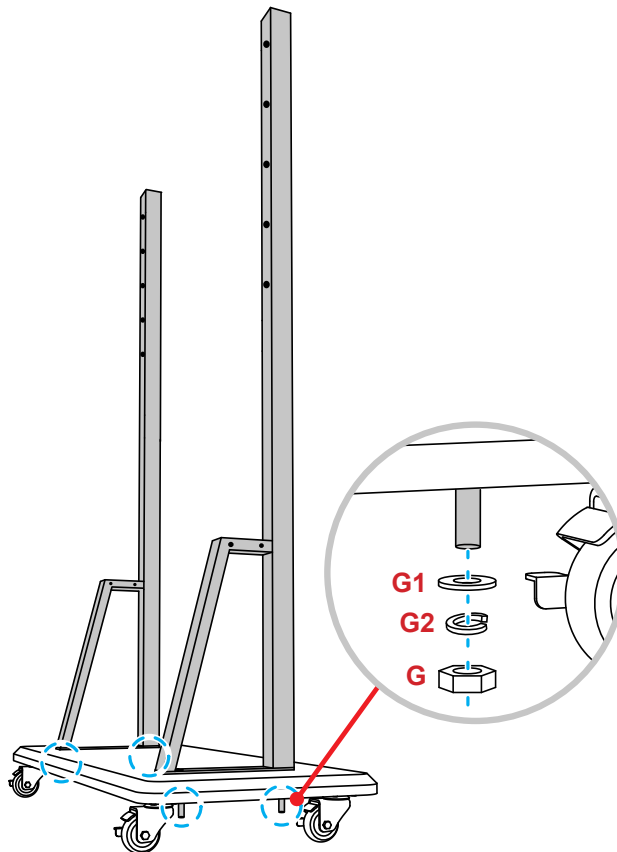

SETUP AND INSTALLATION

4. Align the pen tray with the screw holes on the middle part of the poles, then secure the pen tray with four screws (H).

5. Install the wall mount on the upper part of the poles, then insert the screws (K) through the screw holes from the rear side of the poles.

*** Please Note:**

- a) For safest use and to avoid risk of tipping, do not mount at highest point on ST01 stand.
- b) Do NOT stand underneath ST01 stand when adjusting mount height.

6. Place the washers (K1) and the nuts (K2) into the screws, then tighten the nuts (K2) to secure the wall mount in place.

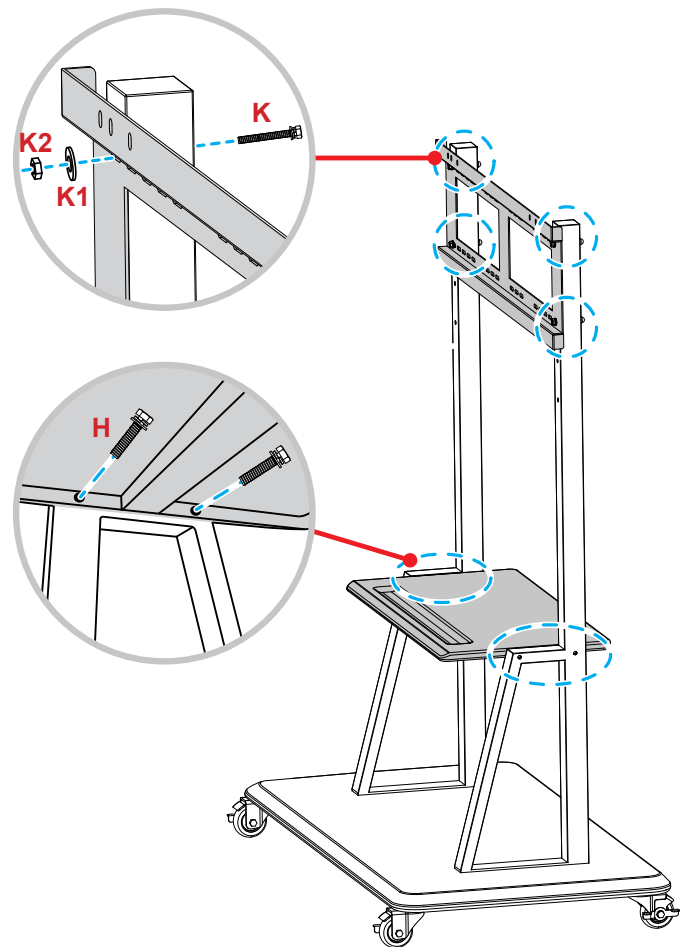

7. Align and hook the dual mounting brackets to the installed wall mount on the stand poles.

*** Please Note:**

Do not operate or place the ST01 stand on a sloped surface as this can cause rolling and/or result in injury or harm to self and others.

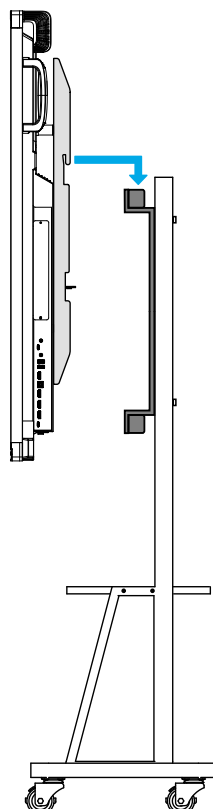

SETUP AND INSTALLATION

Using the Remote Control

Installing/Replacing the Remote Control Batteries

Two (2x) AAA size batteries are supplied for the remote control.

IMPORTANT! *Replace only with the same or equivalent type batteries.*

1. Remove the cover of the battery compartment.

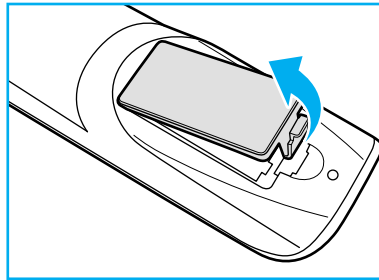

2. Insert the two batteries with correct polarity (+/-) as shown inside the battery compartment.

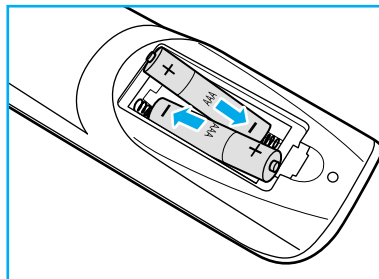

3. Replace the cover.

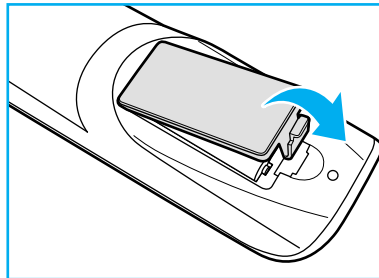

CAUTION

Improper use of batteries can result in chemical leakage or explosion. Be sure to follow the instructions below.

- Do not mix batteries of different types. Different types of batteries have different characteristics.
- Do not mix old and new batteries. Mixing old and new batteries can shorten the life of new batteries or cause chemical leakage in old batteries.
- Remove batteries as soon as they are depleted. Chemicals that leak from batteries that come in contact with skin can cause a rash. If you find any chemical leakage, wipe thoroughly with a cloth.
- The batteries supplied with this product may have a shorter life expectancy due to storage conditions.
- If you will not be using the remote control for an extended period of time, remove the batteries.
- When you dispose of the batteries, you must obey the law in the relative area or country.

SETUP AND INSTALLATION

Remote Control Operating Range

When using the remote control, make sure to point it within $\pm 30^\circ$ to the IR receiver on the IFP. The distance between the remote control and the IR sensor window should not be longer than 8 meters (~ 25 feet).

- Make sure that there are no obstacles between the remote control and the IR sensor window on the IFP that might obstruct the infra-red beam.
- Make sure the IR transmitter of the remote control is not being used where direct sunlight or light from fluorescent lamps can interfere with the infra-red beam.
- If the remote control is close to Inverter-Type fluorescent lamps, it might cause intermittent service issues.
- If the remote control and the IFP are too close together, the remote control may not function or experience intermittent issues.

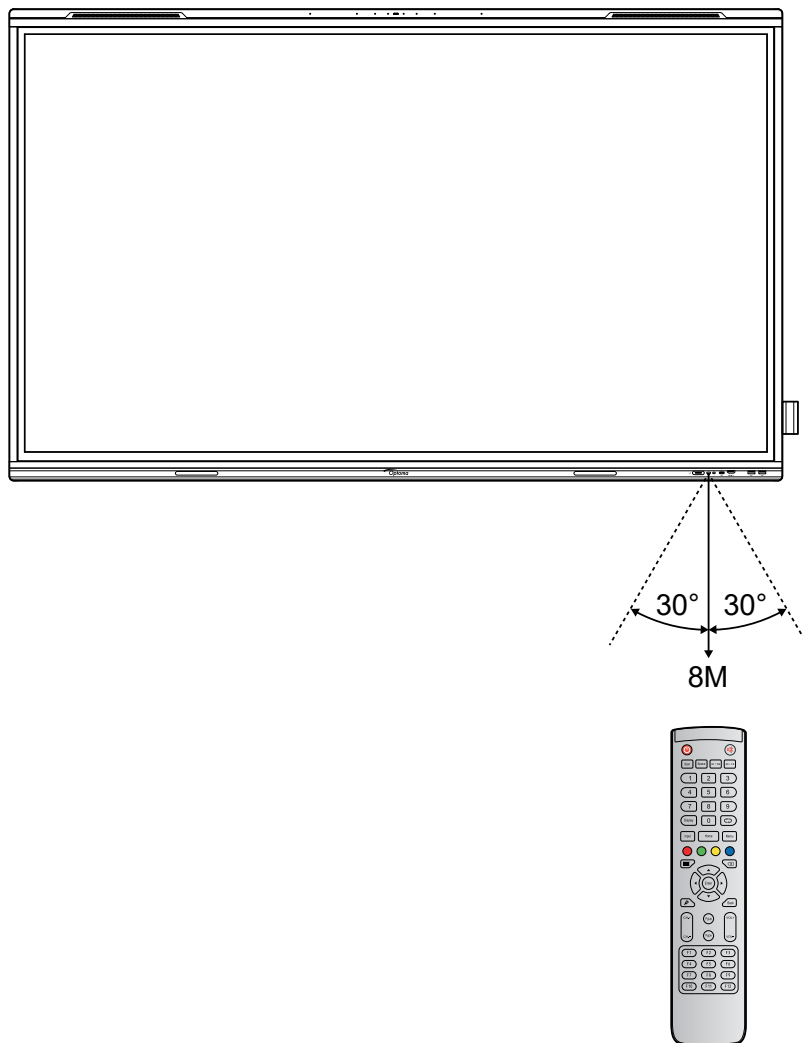

SETUP AND INSTALLATION

Connections

Connecting to Power

1. Connect one end of the power cord to the AC-in socket on the IFP.
2. Connect the other end of the power cord to a power outlet or a power supply.
3. Set the **Power** switch to ON (I). The IFP will automatically enter standby mode.



Connecting External Devices

IMPORTANT! To use the touch screen function, make sure to connect one end of the USB cable to the USB type-B TOUCH 1 or TOUCH 2 port on the IFP and the other end of the cable to the USB type-A port on your device.

HDMI input connection

- Connect your computer to the IFP using an HDMI cable.

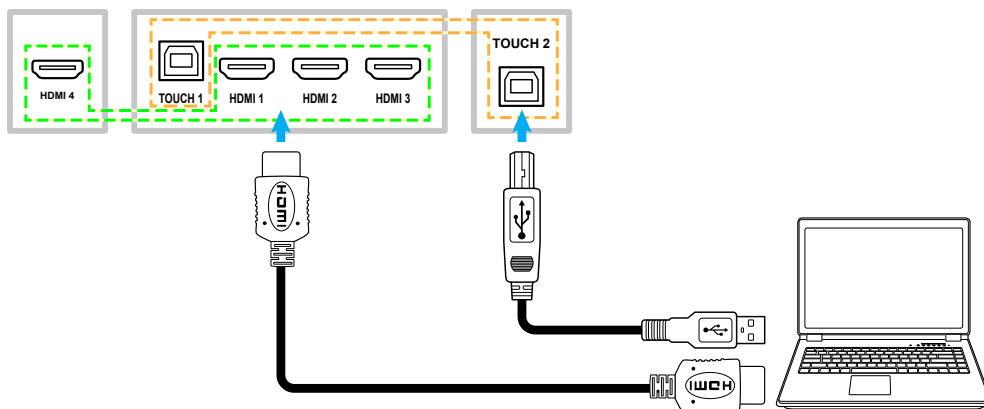

- Connect your video source to the IFP using an HDMI cable.

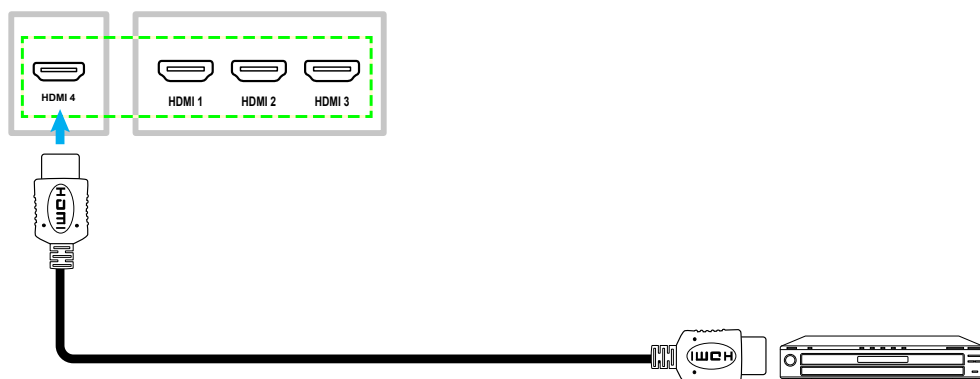

SETUP AND INSTALLATION

USB type-C input connection

Connect your computer to the IFP using a USB type-C cable.

Note:

- *USB type-C can be used to transmit audio, video and touch signals.*
- *Both USB type-C ports on the rear and in the front of the IFP support Network Sharing 100M.*
- *The front USB type-C port supports power delivery up to 100W and the rear USB type-C port supports power delivery up to 15W.*

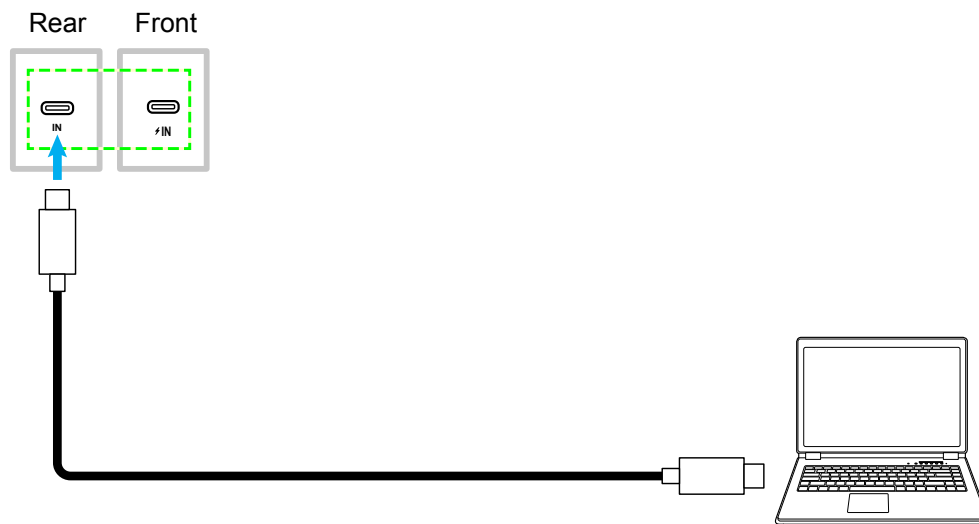

DisplayPort connection

Connect your electronic device to the IFP using a DisplayPort cable.

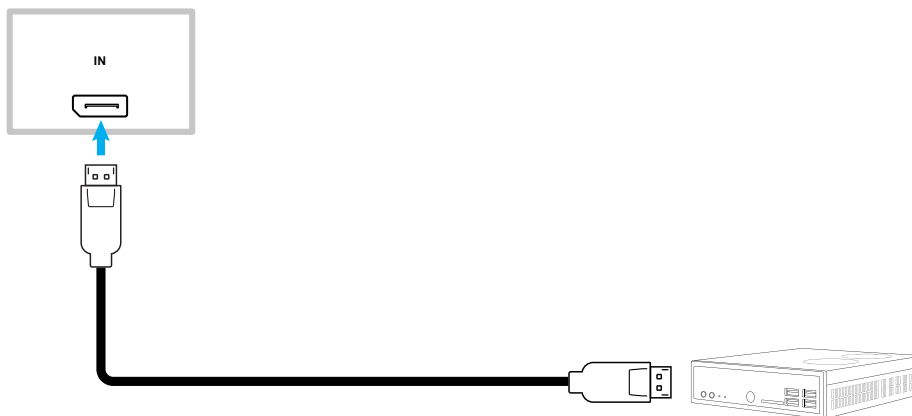

Audio input connection

Connect your external microphone to the Audio-in port on the IFP.



SETUP AND INSTALLATION

Audio output connection

Connect your external speakers to the Audio-out port on the IFP.



SPDIF connection

Connect your audio equipment to the IFP using a SPDIF cable.

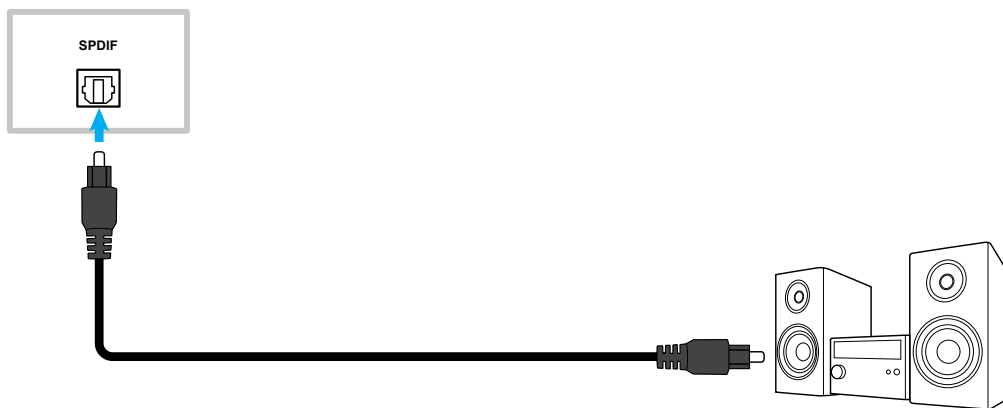

HDMI output connection

Connect your projector to the HDMI out port on the IFP.

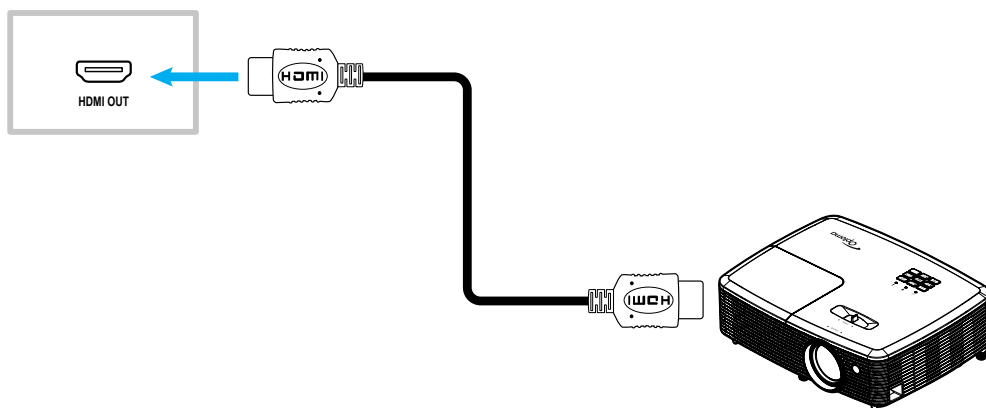

SETUP AND INSTALLATION

USB type-C output connection

Connect your display to the USB type-C out port on the IFP.

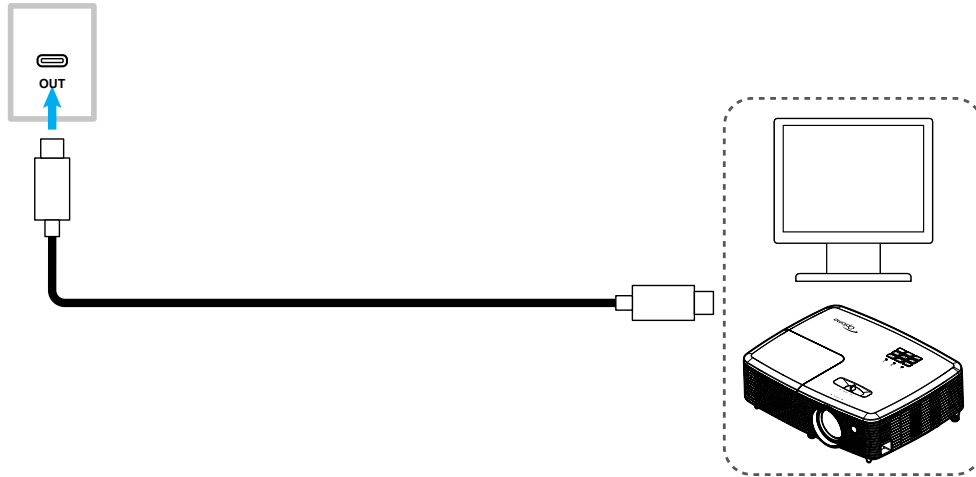

USB connection

Connect your USB peripheral device to the IFP using a USB cable.

Note:

- For a USB flash drive, simply plug it into one of the available USB ports.
- USB 2.0 port is reserved for firmware upgrades and the USB quick-draw pen holder.

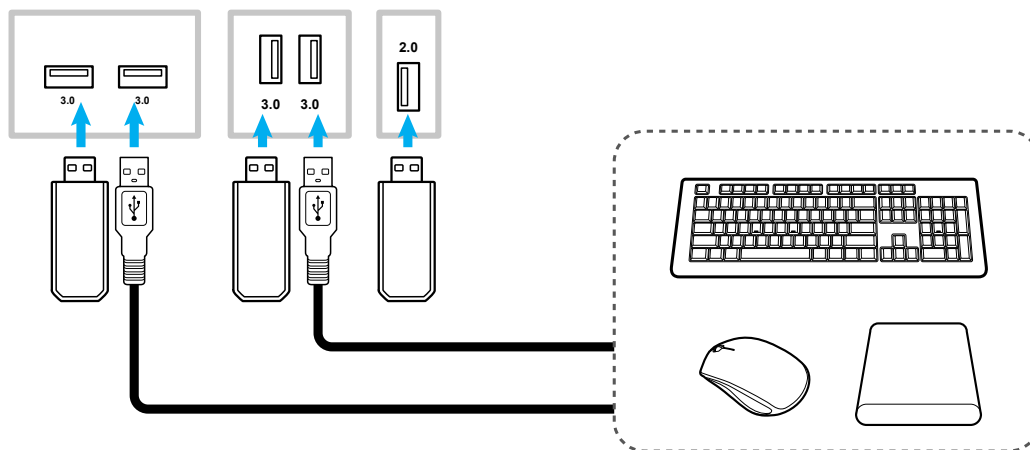

SETUP AND INSTALLATION

RS232 connection

Connect your computer to the IFP using a RS232 cable.

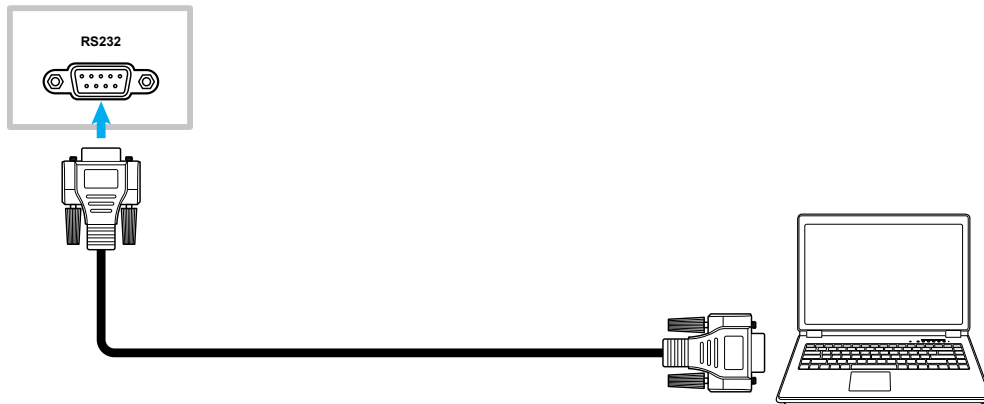

LAN connection

Connect your IFP to the network using an Ethernet cable.

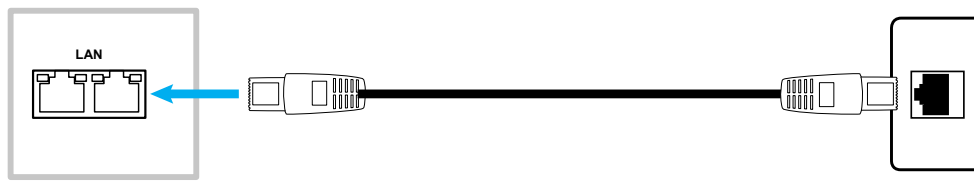

Note: To configure network settings, refer to “Configuring Network Settings” on page 47.

SETUP AND INSTALLATION

Wi-Fi connection

For Wi-Fi connection, you need to install a Wi-Fi dongle to the Wi-Fi slot on the bottom of the IFP. Wi-Fi dongle can receive the signal in an area where there is a Wi-Fi network.

To install the Wi-Fi dongle, complete the following steps:

1. Remove two (2) screws from the Wi-Fi slot bracket.
2. Remove the Wi-Fi slot bracket.

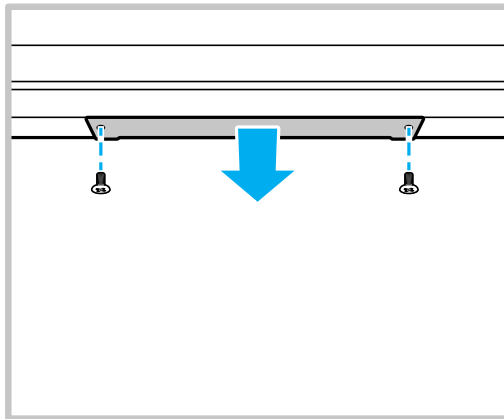

3. Insert the Wi-Fi dongle to the Wi-Fi slot on the IFP.

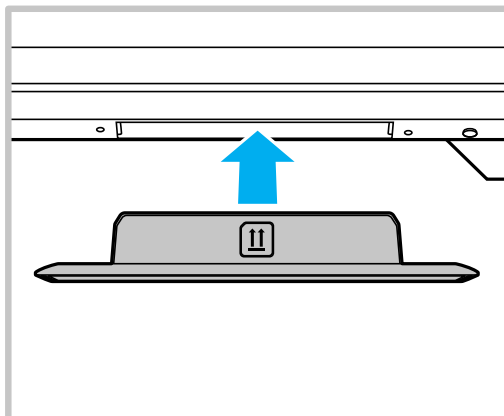

4. For Wi-Fi dongles with holes on either side, please use the included screws to secure the dongle to the IFP.

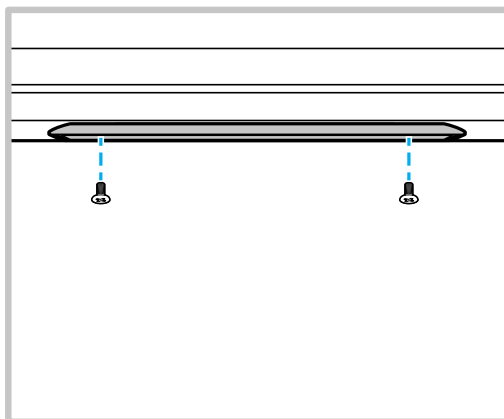

Note: To configure Wi-Fi settings, refer to “Configuring Network Settings” on page 47.

SETUP AND INSTALLATION

Connecting the USB Quick-draw pen holder

To install the Quick-draw pen holder, complete the following steps:

1. Attach the magnetic pen holder to the lower right-hand side of the screen.
2. Connect the USB cable of the pen holder to the USB 2.0 port on the downward-facing I/O panel on the IFP.

Note: *If the pen holder is plugged into the USB 2.0 port then the pen holder trigger function can be used for multiple sources. If the pen holder is plugged into a USB3.0 port then it can be used only with Android source.*

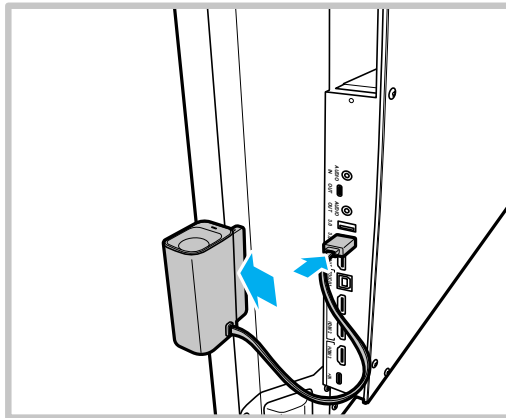

3. Insert the touch pen to its holder.

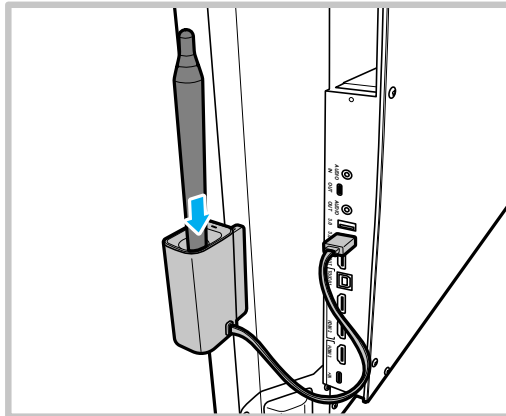

Note: *If the IFP screen is on the Home screen, then removing the touch pen from its holder launches by default the **Whiteboard**. To customize the pen holder trigger action, refer to the setup instructions for this feature (page 50) under the Configuring Device Settings section.*

SETUP AND INSTALLATION

Sensor box connection

Sensor box detects motion in front of the IFP, reads NFC devices/contactless smart cards, measures the room temperature, humidity, and air quality. To install the sensor box, complete the following steps:

1. Align the screw holes on the sensor box with the screw holes under the IFP screen.
2. Secure the sensor box to the IFP with the captive screws.

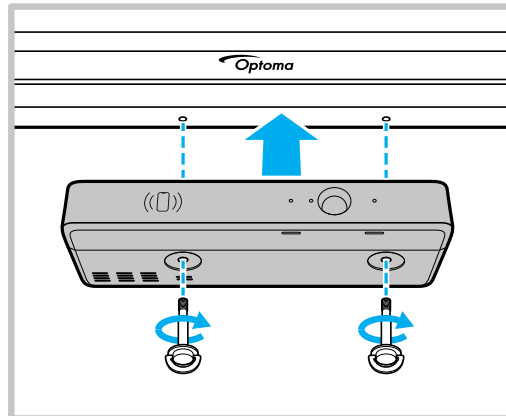

3. Connect the USB type-B end of the USB cable to the sensor box and the USB type-A end to an available USB port on the IFP.

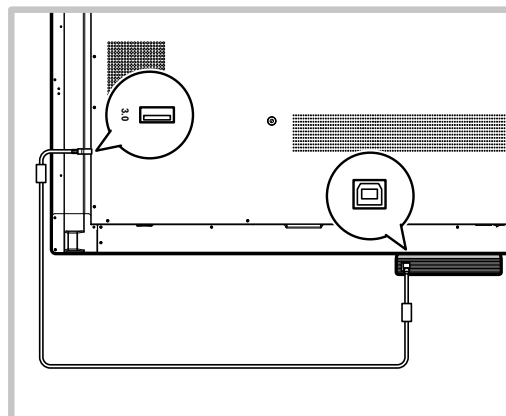

Note:

- Powering on the IFP will also power on the sensor box.
- Sensor Box installations with NFC card integrations may require additional equipment or devices, such as a NFC reader/writer to format and write to compatible NFC cards based on the compatibility specifications below.

Supported NFC specifications: ISO 14443 & ISO 15693 @ 13.56Mhz

For Optoma Account Manager (OAM) user setup, Decimal ID may be required, which can be obtained from a compatible NFC reader.

USING THE DEVICE

Turning the Power On/Off

Powering On

Note: After the power cord is properly connected, make sure the **Power** switch is set to ON (I).



Press the **Power** button to turn on the IFP. The LED indicator light turns white, indicating it is ready to use.

Note: You can also press the  button on the remote control to turn on the IFP.

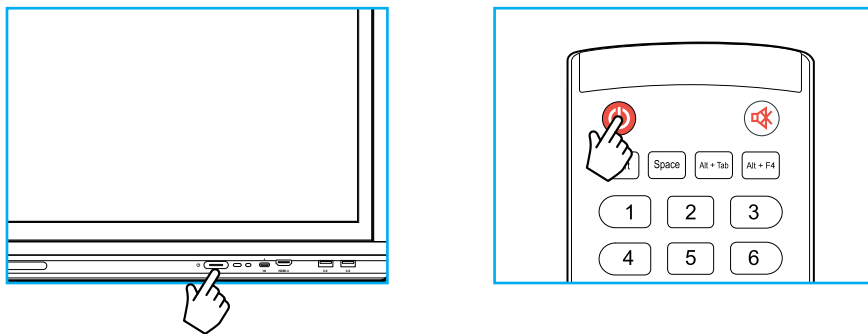

Powering Off

Press the **Power** button for 3 seconds to turn off the IFP. Press **OK** at the prompt to turn it off immediately or wait for 10 seconds until the IFP turns off automatically.

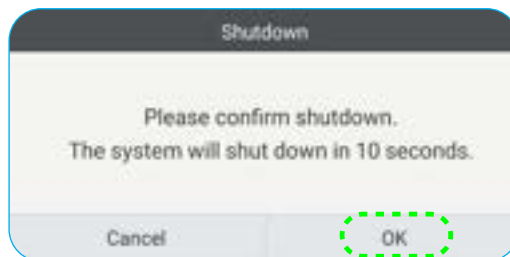

When the LED indicator light turns red, this indicates that the IFP has entered standby mode.

Note:

- You can also press the  button on the remote control to turn off the IFP.
- The IFP still consumes power when it is in standby mode. It is highly recommended to unplug the power cord from the power outlet if the IFP will not be used for an extended period of time.

USING THE DEVICE

Setup Wizard

The Setup Wizard will appear on the screen when you turn on your IFP for the first time. You are prompted to configure some basic settings, such as language, Wi-Fi, security, and more. Follow the onscreen instructions to complete the initial setup.

Note: *This IFP is equipped with a touch-sensitive screen. You can simply tap the touch screen to operate your IFP.*



BASIC OPERATIONS

Home Screen Overview

Home screen is displayed every time you start the IFP.



To navigate the Home screen, do any of the following:

- Swipe down from the upper edge of the screen to open the quick settings panel.
- Swipe up on the screen to view all the apps.
- Select an option: Simply tap on the desired item.
- Adjust the Home screen layout: Press and hold on an item (such as an app icon or widget), then simply drag and drop to move it to your desired spot.
- Open the side toolbar: tap > or < on the left or right side of the screen.

Note:

- *Unless otherwise specified, this section describes IFP operations using touch gestures.*
- *You can also use the remote control to operate the IFP.*

BASIC OPERATIONS

OSD Menu

To open the OSD menu, do any of the following:

- On any screen, open the side toolbar by tapping on the > or < on either side of the screen. On the side toolbar, tap on the ≡ icon to open the OSD menu.



- Press the **Menu** or **Input** button on the remote control.

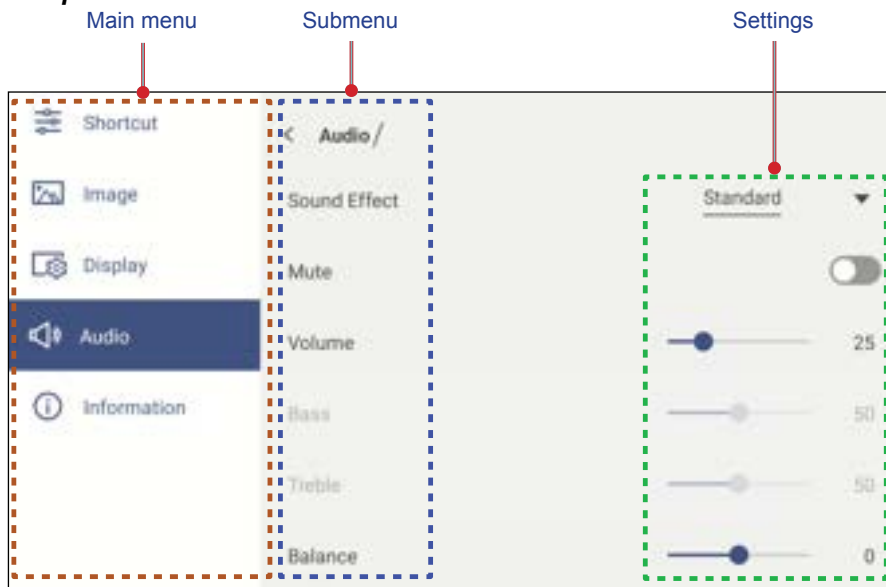

- To configure the OSD menu settings, simply touch the menu item on the screen and use the screen controls to adjust its value or set the setting. The selected menu item is highlighted in **blue**.
- To move to the previous item in the menu, tap < or press **Back** on the remote control.
- To close the OSD menu, touch anywhere on the screen outside the menu or press **Back** continuously (if necessary) on the remote control.

BASIC OPERATIONS

Shortcut Menu

Shortcut  menu is the first OSD menu. Complete the following steps:



- Select the input source. Those input sources that are active are marked with the DOT  symbol.



Note:

- For more information on making connections to external devices, refer to the “Connections” section.
- The OPS option is only available if the PC module is properly installed into the OPS slot of the IFP.

BASIC OPERATIONS





- Select **PIP mode** to display two sources on the screen simultaneously.

Note:

- *Before selecting the PIP mode, make sure the other source is already connected to the panel.*
- *The PIP mode can only be initiated from the Android Home screen.*



Select any of the following:

- **Sources** to select the second source that you want to display on the screen.
- **Size**  to select the second source window size. The available options: Large, Medium, or Small.
- **Sound**  to adjust the second source sound.
- **Position**  to adjust the second window position. The available options: Top-left, Bottom-left, Top-right, Bottom-right, or Center.
- **Enter**  to close the PIP mode and switch to the second source.
-  to close the PIP mode and display the primary source only.

BASIC OPERATIONS





- Select **Screen record** to record video from the panel's screen and connected camera screen (if enabled) and host live stream on multiple platforms.

Note:

- You can drag the recording utility to your preferred location on the screen.
- The screen recording utility can only be used with Android source.



Select any of the following:

- **Record**  to start recording the screen. The recording starts 3 seconds after you select . While recording, select  to pause recording or  to stop recording. Then select **Save** to save the recording.
- **Settings** to configure recording settings: enable or disable connected camera recording, enable/disable microphone function, select the preferred video resolution, and select the path where you want the recordings to be saved. Then select **Confirm** to save the settings.

Note: By default, all recordings are saved to the Storage/Record folder.

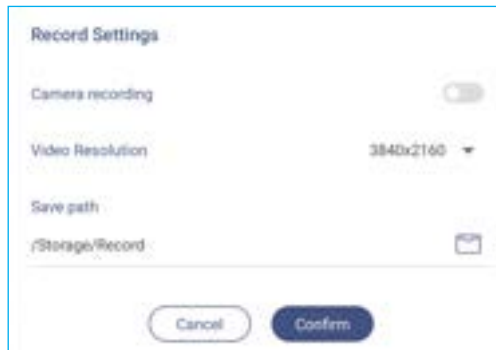

- **EXIT** to close the recording tool.

- Drag the backlight slider bar to the right or to the left to adjust the backlight level.

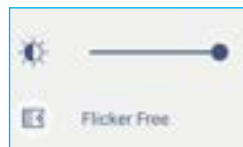

Note: For a comfortable viewing experience, you can enable Flicker Free function.

- Drag the low blue light slider bar to the right or to the left to adjust the low blue light level.

IMPORTANT! Studies have shown that just as the ultra-violet rays can cause eye damage, the shortwave-length blue light rays from displays can cause eyestrain, retina damage, and affect vision over time. Optoma Low Blue Light is an eye protection feature that can reduce the blue light.



IMPORTANT! For protecting your eyes against prolonged display use, we highly recommend you to do the following:

- Let your eyes rest for 10 minutes after 2 hours of continuous use.
 - Roll your eyes upward towards your eyebrows, and then roll your eyes in a large circle every few hours.
 - For every 20 minutes of display viewing, look into the distance for 20 seconds.
 - When your eyes get sore, close your eyes for a minute.
- Drag the volume slider bar to the right or to the left to adjust the volume level.



BASIC OPERATIONS

Configuring the Image Settings

In the OSD menu, tap  to open the Image menu, then complete the following steps:



- Tap **Display Mode** and select one of the available options: Presentation, Bright, Cinema, HDR, or User.

Note:

- *Image settings can only be adjusted in HDMI, DisplayPort, OPS, and Type-C input. It can't be adjusted and will be grayed-out in Android source.*
 - *If the Display Mode setting is set to **User**, you can customize image settings by adjusting the brightness, contrast, and color settings based on your preferences.*
- Drag the **Brightness** slider bar to the right or to the left to adjust the screen brightness level.
 - Drag the **Contrast** slider bar to the right or to the left to adjust the screen contrast level.
 - Drag the **Color** slider bar to the right or to the left to adjust the screen color level from black and white to fully saturated color.
- Note:** *Brightness level, contrast level, and color level can be adjusted only if the Display Mode is set to **User**. In other display modes these parameters are preset and cannot be adjusted.*
- Tap **Color Temperature** and select one of the available options: Standard, Cold, Warm, or Auto.
 - Tap **Color Correction** to automatically optimize the screen color.
 - Tap AI Picture Quality(**AI PQ**) to enable real-time face and scene recognition using the integrated AI processing units for the best visual experience.
 - Tap **Reset** to reset all image settings to their defaults.



BASIC OPERATIONS

Configuring the Display Settings

In the OSD menu, tap  to open the Display menu, then complete the following steps:



- Tap **Aspect Ratio** and select one of the available options: 16:9, 4:3, or PTP (Pixel To Pixel).
Note: For 4K input, the aspect ratio will be locked to PTP. For non-4K input, PTP will be grayed out and user can select only 4:3 or 16:9 as aspect ratio.
- Tap **Pixel Shift (min)** and select one of the available options: Off, 2, 3, 5, 30, or 60.
Note:
 - Pixel shift feature helps to prevent image retention.
 - Pixel shift is supported with all input sources except for Android.
- Drag the **Backlight** slider bar to adjust the backlight level.
Note: Backlight can be adjusted also in the Shortcut menu. Refer to page 35.
- Drag the **Low Blue Light** slider bar to adjust the blue light level.
Note: Low Blue Light can be adjusted also in the Shortcut menu. Refer to page 35.
- Tap **Dynamic Black** and select one of the available options: Off, Based on Content (not supported in Android), or Based on Ambient light.
Note: Dynamic black feature gives more depth to your image so that bright scenes appear crisp and clear, while dark scenes remain detailed with deep blacks and exceptional light and shade detail.
- Tap **Auto AV mute** and select one of the available options when the screen backlight is turned off and audio is muted: Off, by Ambient light, by PIR, or by Ambient light & PIR.
Note: When using the optional WL10C Sensor box, PIR options for Auto AV mute will turn the display on when movement is detected within 5 meters (~16 feet).

BASIC OPERATIONS

Configuring Audio Settings

In the OSD menu, tap  to open the Audio menu, then complete the following steps:



- Tap **Sound Effect** and select one of the available options: Standard, Meeting, Class, Movie, or User.
Note: If the sound effect setting is set to **User**, you can customize audio settings by adjusting the bass and treble level according to your preference.
- Tap **Mute** to mute or unmute audio.
Note: You can also mute or unmute audio by pressing the  button on the remote control.
- Drag the **Volume** slider bar to adjust the volume level.
- Drag the **Bass** slider bar to adjust the bass level that is suitable for your room.
Note: Bass level and treble level can be adjusted only if the Sound Effect is set to **User**. In other sound effect modes this parameter is preset and cannot be adjusted.
- Drag the **Treble** slider bar to adjust the treble level that is suitable for your room.
- Drag the **Balance** slider bar to adjust the sound balance level that is suitable for your room.

BASIC OPERATIONS

Viewing Device Information

In the OSD menu, tap  to open the Information menu, then complete the following steps:



- Tap **Display** to view display mode, current input source, and resolution.
- Tap **About** to view model name, regulatory model name, serial number, firmware version, and Android version.

BASIC OPERATIONS

Android Settings Menu

To open the Settings menu, tap > or <=> ⚙️ on the Home screen.

Note: Settings can be modified only in Android mode.

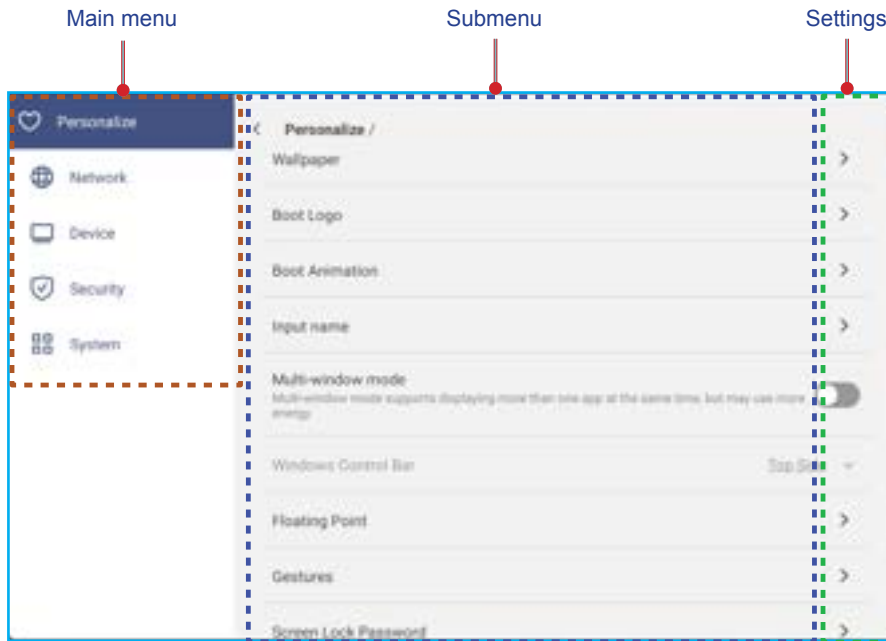

Note:

- To configure Android settings, simply touch the menu item on the screen and use the screen controls to adjust its value or set the setting. The selected menu item is highlighted in blue.
- To move to the previous item in the menu, tap < or press **Back** on the remote control.
- To close the OSD menu, touch anywhere on the screen outside the menu or press **Back** continuously (if necessary) on the remote control.

Personalizing the System

In the Settings menu, tap ❤️ to open the Personalize menu, then complete the following steps:



BASIC OPERATIONS

- Tap **Wallpaper** and select a pre-loaded image as a wallpaper or an image from your gallery.

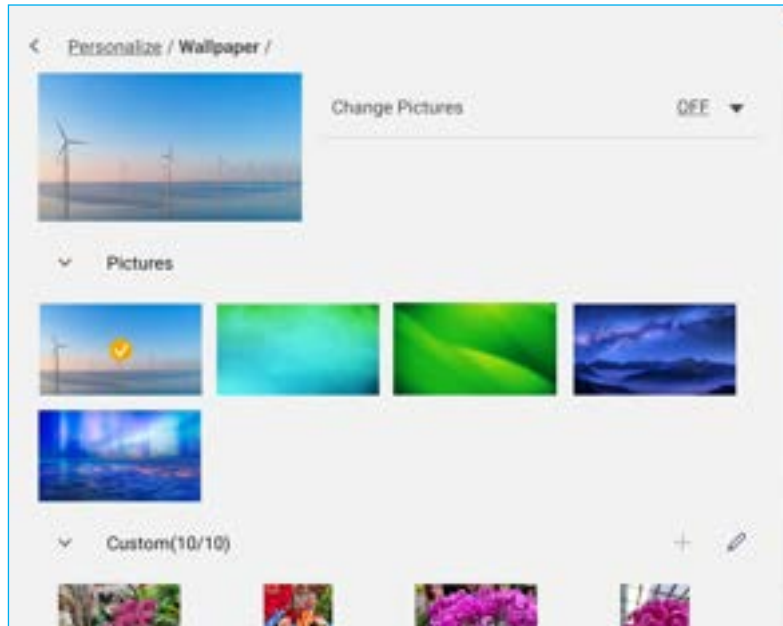

If you select a pre-loaded wallpaper from the Pictures folder, the setting will take effect immediately.

If you prefer to use a customized wallpaper, follow the steps:

- a) In the Custom folder, tap .
- b) Select your preferred image from the local or external storage and tap **OK**. You can import up to 10 images.
- c) In the Custom folder, tap on the image you wish to use as a wallpaper. The setting takes effect immediately.

Note: To delete images in the Custom folder, tap . Then select the image and tap **Delete**.

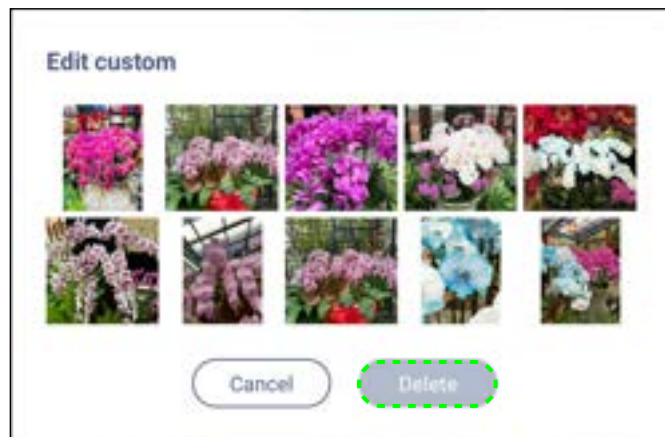

- **Change pictures:** Select the slideshow interval from 5 mins to 1 day. By default the slideshow is off.

Note: You can also set a wallpaper with a single finger press+hold anywhere on the Home screen or from the **File Manager** gallery. For more information on the **File Manager**, refer to page 92.

BASIC OPERATIONS

- Tap **Boot Logo** to modify the boot logo. Follow the steps:
 - a) In the Custom folder, tap +.
 - b) Select your preferred image from the local or external storage and tap **OK**. You can import 1 image at a time. The image must be in JPEG/JPG format with the resolution 1920x1080. After importing the logo image, tap on it and then you can see it in the preview window.
 - c) To delete the logo image in the Custom folder, tap . Then select the image and tap **Delete** or tap **Reset to default** to display the default logo during startup.



- Tap **Boot Animation** to modify the boot animation. Follow the steps:
 - a) In the Custom folder, tap +.
 - b) Select your preferred video from the local or external storage and tap **OK**. You can import 1 video at a time. The boot animation video must be in MP4 format and not larger than 8MB. After importing the video, tap on it and then you can see it in the preview window.
 - c) To delete the logo image in the Custom folder, tap . Then select the video and tap **Delete** or tap **Reset to default** to display the default animation during startup.

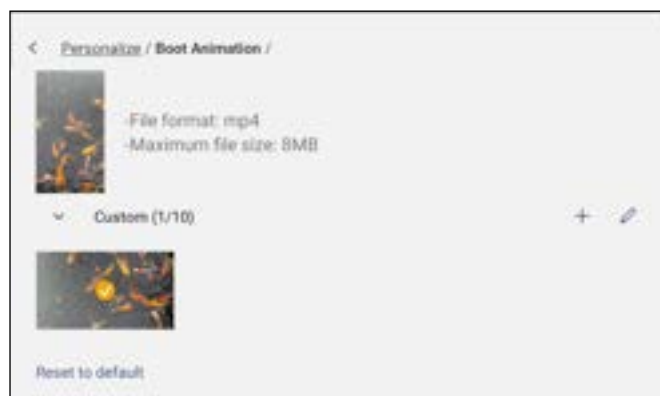

- Tap **Input Name** to rename the input. Tap on the input name you wish to change, then type a new name and confirm name modification by tapping **OK** at the prompt.



BASIC OPERATIONS





- Tap **Multi-Window mode** to enable the display of more than one app on the screen at the same time. Tap **Restart** to save this change and reboot the IFP.

Note: Multi-window mode consumes more computing power and it will increase system loading times.



To manage app windows in multi-window mode, do any of the following:



- Move the app window in any of the four directions on the screen.
 - Tap  to minimize the app window.
 - Tap  or drag the app window to the right or upper corner of the screen to view the app in full screen mode.
 - In full screen mode, drag the upper edge of the screen down and then tap  to see the app in a window.
 - Tap  to close the app.
- Tap **Windows Control Bar** and select at which edge of the app window you want to display the Windows Control bar in the multi-window mode. The available options: Top Side, Left Side, or Right Side.
 - Tap **Floating Point** and enable or disable the floating point feature. If enabled, you can customize the apps that are displayed at the bottom of the floating point.



BASIC OPERATIONS

- Tap **Gestures** and enable the feature. Then you can assign functions to different gestures.



- Tap **Screen Lock Password** and select the screen locking method. The available options: Swipe, Pattern, PIN, and Password. Select None if you want to keep the screen unlocked.

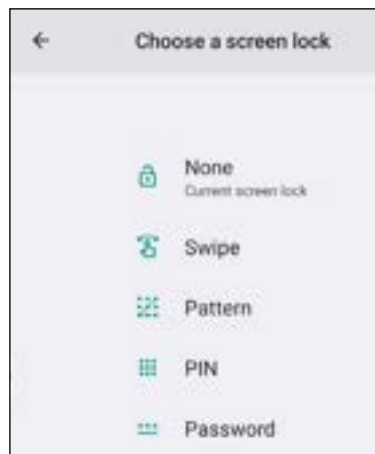

BASIC OPERATIONS

Configuring Network Settings

In the Settings menu, tap  to open the Network menu, then complete the following steps:

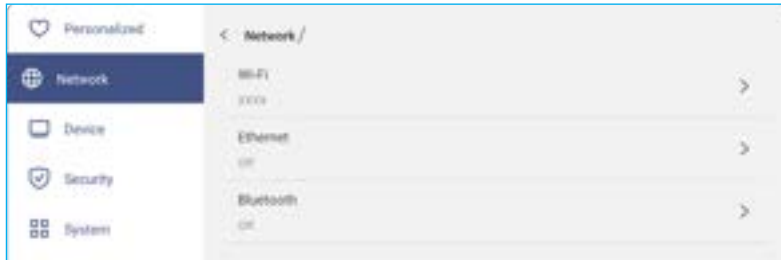



- Tap **Wi-Fi** to connect the IFP to the Wi-Fi network and view current connection status. Make sure the Wi-Fi function is enabled. In the Available network list, tap on your preferred Wi-Fi network, for example XXXX (2). Provide an access password if needed.

IMPORTANT! To connect to a Wi-Fi network, make sure the Wi-Fi dongle is properly installed in the Wi-Fi dongle slot. For more information, refer to page 28.

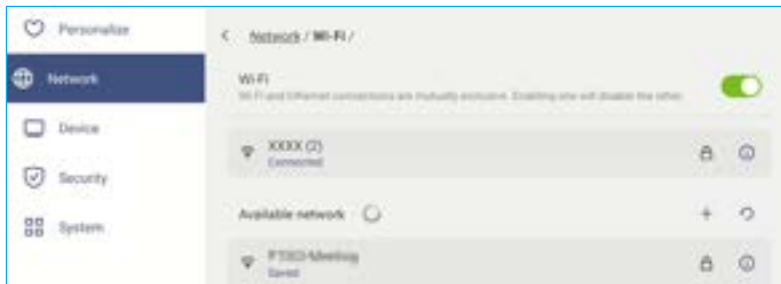
Note: Wi-Fi and Ethernet connections are mutually exclusive. Enabling one will disable the other.



Note: If your preferred Wi-Fi network is not visible in the list, tap  to refresh the list. To enter the Wi-Fi network manually, tap .

- Enable **Portable hotspot** feature to share the Wi-Fi network with other wireless devices. Modify the network name and set an access password if necessary.

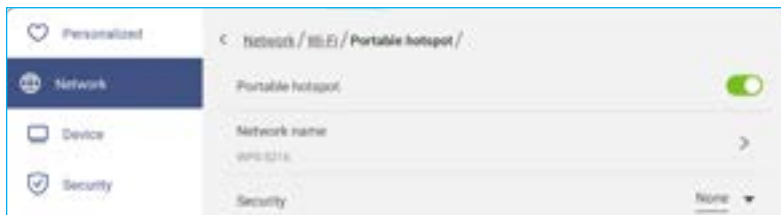

Note: For a secure connection, set the Wi-Fi encryption (Security field) as **WPA2-Personal**. Then enter the access password and tap **OK**.

BASIC OPERATIONS

- Tap **Ethernet** to configure LAN settings and view the current connection status. Enable Ethernet, then in the IP settings section select the network type between static and DHCP. If you set the network type as **Static** then enter the connection settings, such as IP address, gateway, network prefix length, and more at the prompt. Tap **OK** to save the settings.

To reset the Ethernet settings, tap **Reset**.

IMPORTANT! To connect to a wired network, make sure the IFP is connected to LAN. For more information, refer to page 27.

Note: Wi-Fi and Ethernet connections are mutually exclusive. Enabling one will disable the other.

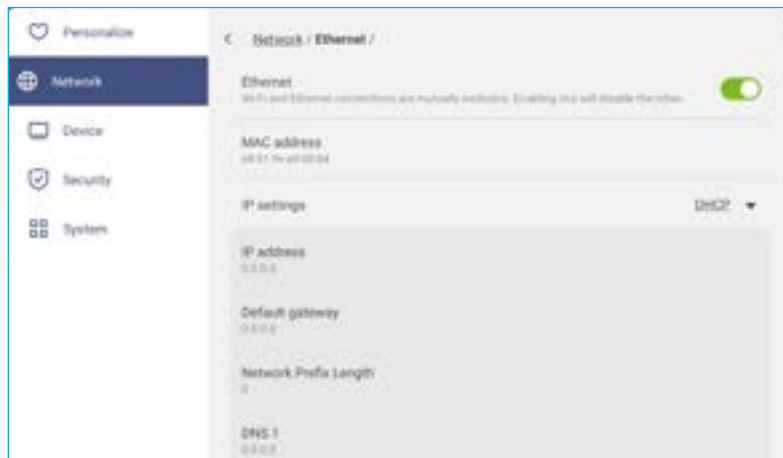

- Tap **Bluetooth** to enable Bluetooth and connect to other nearby Bluetooth devices. This interactive display supports Bluetooth version 5.x (dependent upon wireless dongle used) and can connect for example to a Bluetooth keyboard, mouse, and speaker.

Tap the following:

- **Device Name** to enter a new device name. To confirm the modification, tap **OK** at the prompt.
- In the list of *Available device*, select the device you want to connect to.

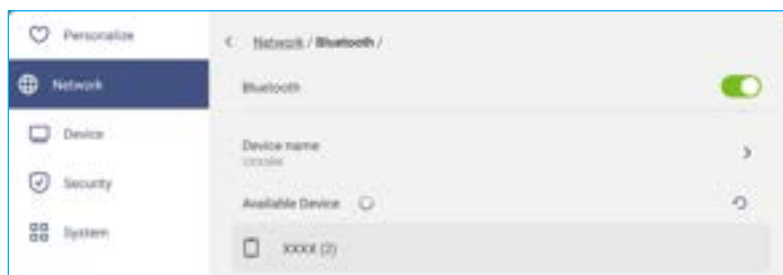

Make sure the pairing codes match on both devices and if they match, tap **Pair** to confirm.

IFP



Portable Device



Note: If the Bluetooth device is not visible in the list of available devices, make sure the device is nearby the IFP and Bluetooth is enabled. Then tap  to refresh the list.

- Tap **VPN** to add a VPN profile.
- Tap **Host name** to rename the IFP.

BASIC OPERATIONS

Configuring Device Settings

In the Settings menu, tap  to open the Device menu, then complete the following steps:



- Tap **HDMI out Encryption Setting** to enable or disable encrypting HDMI out signal with HDCP.
Note: *If the connected monitor does not support HDCP, disable HDMI out encryption function.*
- Tap **HDMI out Format** and select the format that can be output from the HDMI port.
- Tap **TypeC out Format** and select the USB type-C out format.
- Tap **Auto Source-Switching** to enable or disable switching input sources automatically.
- Tap **Device ID** to assign a new ID to the IFP. To confirm, tap **OK**.

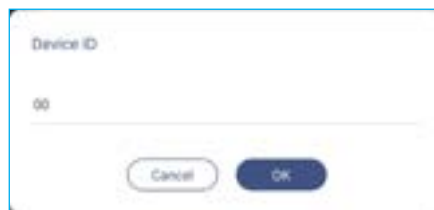

- Tap **Storage** to view storage usage.

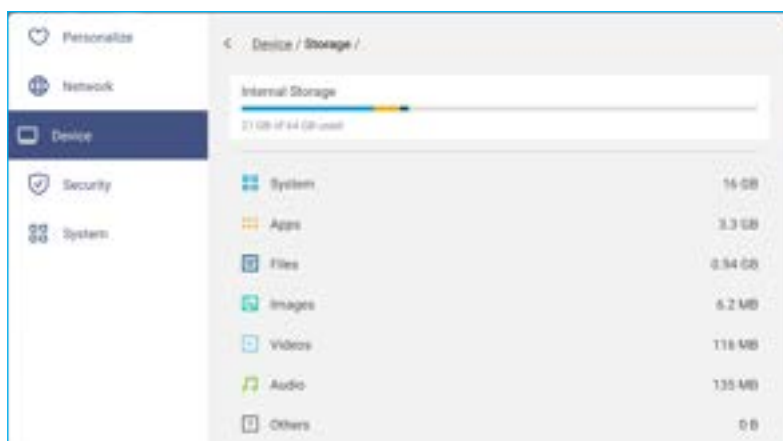

BASIC OPERATIONS

- Tap **Apps** to view apps information, disable or force stop app, view storage usage, app version, and configure permission settings.

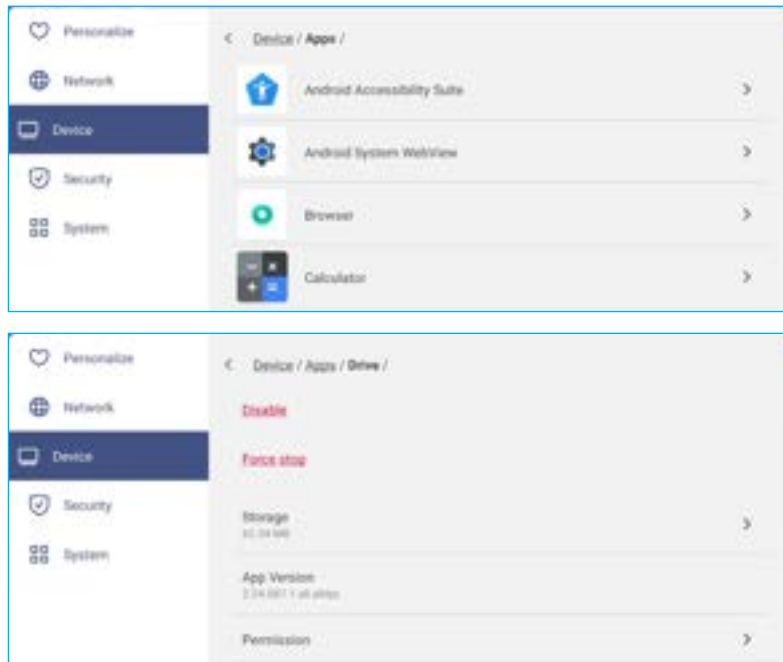

- Tap **Pen holder trigger** and select any of the following trigger actions:
 - **Auto**: When the pen is lifted, the system automatically launches the whiteboard or annotation tools. (Lifting the pen from the Home screen will open the whiteboard. Lifting the pen from any other app or input source will open the annotation tools).
 - **Whiteboard**: When the pen is lifted, the system always launches whiteboard.
 - **Annotation**: When the pen is lifted, the system always launches the annotation tools.
 - **Disabled**: Lifting the pen from the holder does NOT perform any function.
- Tap **Optoma Management Suite** to set up remote management settings. For more information, refer to page 103.
- Tap **Other Settings** to configure side toolbar, enable or disable touch sound, configure navigation bar settings, and sound input & output settings.

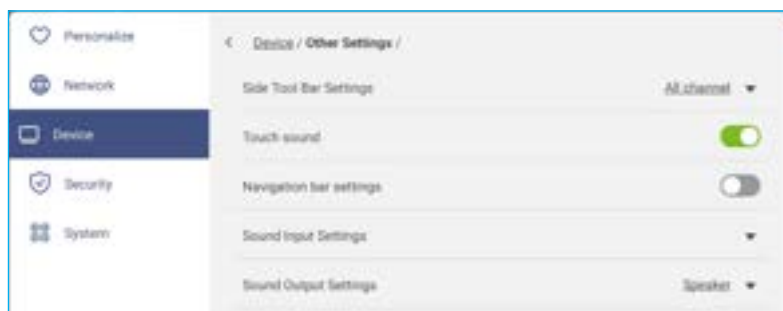

Tap any of the following:

- **Side toolbar settings** to select when the toolbar is visible: All channel, only Android, All channels except OPS, or Disable the side toolbar.
- **Touch Sound** to enable or disable audio feedback when you tap items on the screen.
- **Navigation bar settings** to enable or disable configuring the navigation bar setting.
- **Sound Input Settings/Sound Output Settings** to select the sound input and output sources respectively.

BASIC OPERATIONS

Configuring Security Settings

In the Settings menu, tap  to open the Security menu, then complete the following steps:



- Tap **Advanced Setting** to enter the advanced settings menu.

Note: The **DEBUG MENU** advanced settings can be also accessed with the Advanced Setting password set in this menu.

- a) Enter the Advanced Setting password at the prompt and tap **OK**.

Note: The default password is **1 + 2 + 3 + 4**.

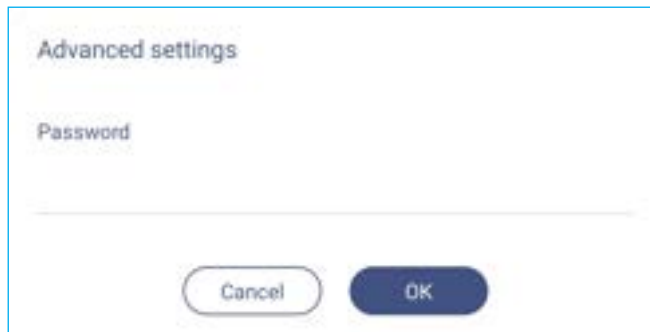

- b) Select any of the following items:

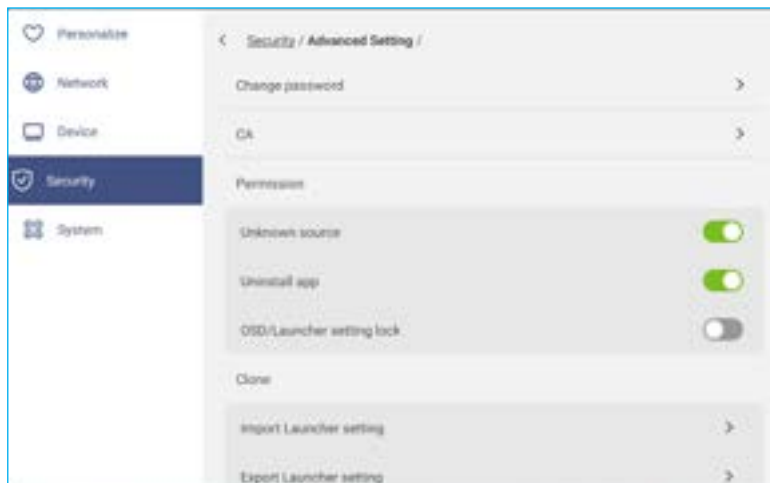

BASIC OPERATIONS

- **Change password:** Enter the current password and twice the new password. Then tap **OK** to confirm.

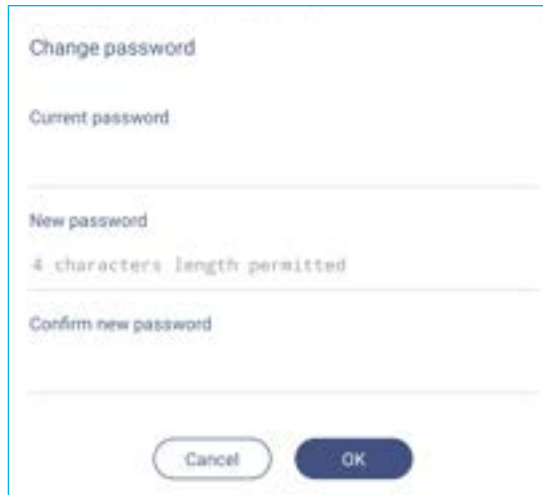

Change password

Current password

New password

4 characters length permitted

Confirm new password

Cancel OK

- **CA:** View and modify trusted CA certificates, user stored credentials, and more.
 - Tap **Trusted credentials** to view and modify trusted CA certificates.
 - Tap **User credentials** to view and modify user stored credentials.
 - Tap **Install from storage** to install credentials from the storage.
 - Tap **Clear all credentials** to remove all user credentials.
- Under Permissions, tap **Unknown source** and enable or disable installing third party software from an unknown source.
- Under Permissions, tap **Uninstall app** and enable or disable uninstalling third party software.
- Under Permissions, tap **OSD/Launcher setting lock** to lock or unlock the OSD/launcher settings.
- Under Clone, tap **Import Launcher setting** to import the launcher settings from an internal or external storage.
- Under Clone, tap **Export Launcher setting** to export the launcher settings to an internal or external storage.
- **Data Wipe:** Select to automate the removal of any user-created data that has been saved to internal storage. The available options are: Always Keep, Delete After One Day, or Delete After One Hour.

BASIC OPERATIONS

Enabling or Disabling USB Wi-Fi/USB Disk

a) Press **Input + 5 + 9 + 8 + 0** buttons on the remote control.

The Dealer Menu opens.



b) Tap **Advanced settings**, then enter the Advanced Setting password at the prompt and tap **CONFIRM**.



c) Tap <= or => next to USB WIFI Enable and select **OPEN**. Then select **CONFIRM** to enable USB WIFI. Once you tap **CONFIRM**, your device will reboot and changes will take effect.

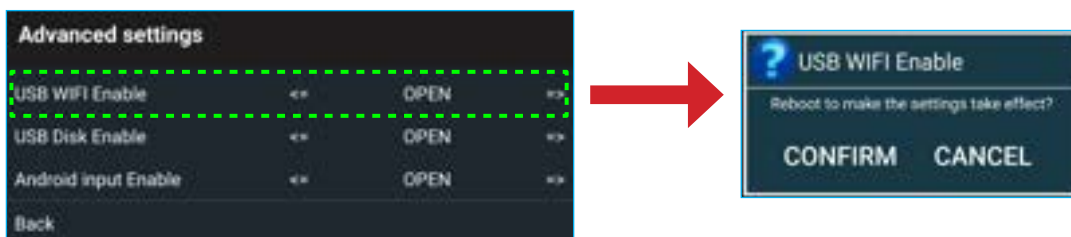

d) Tap **Exit** to exit the Dealer Menu.

BASIC OPERATIONS

Configuring System Settings

In the Settings menu, tap  to open the System menu, then complete the following steps:



- Tap **Date and Time** to configure date and time related settings. Tap any of the following:



- **Auto Date and Time** to enable or disable updating date and time automatically.
- **Time Zone** to select/change the time zone for your area.
- **Use 24-hour format (13:00)** to enable or disable displaying time in 24-hour format.
- Tap **Language** to select one of the available language options: English, Spanish, French, Italian, Dutch, Polish, Portuguese, Romanian, Russian, Swedish, Turkish, Simplified Chinese, and Traditional Chinese.
- Tap **Keyboard** to view and manage keyboards.
- Tap **Startup and Shutdown** to configure settings related to starting and shutting down the IFP. Tap any of the following:

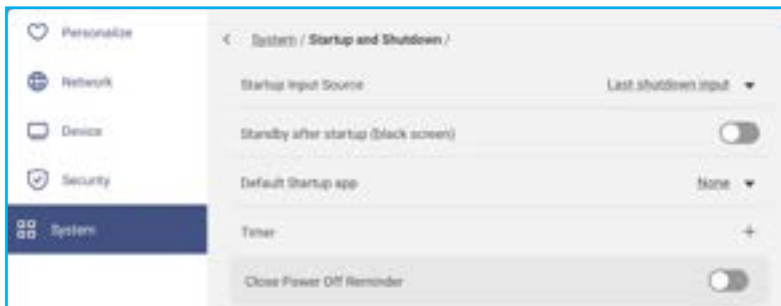

- **Startup Input Source** item to select one of the available startup input options: Last shutdown input, ANDROID, HDMI 1, HDMI 2, HDMI 3, HDMI 4, Display port, TYPEC 1, or TYPEC 2.
- **Standby after startup (black screen)** to enable or disable standby after startup.

BASIC OPERATIONS

- **Default Startup app** to select one of the available startup apps: Url Browser, Browser, Whiteboard, Display Share, or None (display the Home screen after startup).
- **Timers** ⇒ + to set a startup and shutdown timer. To create a schedule, do the following:
 - a) To enable startup timer and/or shutdown timer, select the radio button next to **Startup timer** and **Shutdown timer**.
 - b) Set the time and select the day(s) when you want the IFP to follow this startup or shutdown schedule.
 - c) Tap **Add** to save the timer.



- d) Enable (or disable) the new schedule in Timers menu.

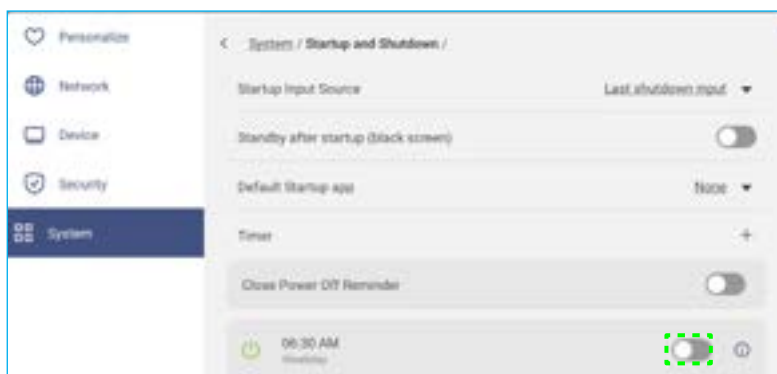

Note:

- Tap ⓘ to modify or remove the schedule.
- You can set up to 3 schedules.

- **Close power off reminder** to enable or disable closing power off reminder when the IFP is scheduled to shut down.

- Tap **Power** to configure power settings. Tap any of the following:



- **Signal Power On** to enable or disable starting up the IFP when an input signal is detected.

BASIC OPERATIONS

- **Direct Power On** to enable or disable starting up when a power source is detected.

Note: Direct power on feature aids installations that rely on power-on timers.

- **Auto Power Off** item to select one of the available time intervals in minutes to automatically power off the IFP when there is no input source found: Off (function is disabled), 1 mins, 3 mins, 5 mins, 10 mins, 15 mins, 20 mins, 25 mins, 30 mins, 35 mins, 40 mins, 45 mins, 55 mins, 60 mins, 120 mins, or 240 mins.

- **Wake on LAN** to enable or disable remotely starting up the IFP over LAN.

Note: Wake on LAN can't work and will be gray out when Power Mode (Standby) is set to **Active**.

- **Power button behavior** item to select the power button behavior. The available options: Google (press and hold the power button to talk to Google Assistant) or Optoma (shut down the IFP).

- Tap **HDMI CEC** to enable or disable any of the available options: Display on then player on, Display off then player off, Player on then display on, or Player off then display off.
- Tap **Power Mode Standby** item to select one of the available options: Eco or Active. By default, **Active** item is not visible. To enable **Active** option, do the following:

a) Press **Input + 5 + 9 + 8 + 0** buttons on the remote control.

The Dealer Menu opens.



b) Tap **OFF** next to Active Standby to toggle the Active Standby OPEN.



c) Tap **Exit** to exit the Dealer Menu.

Active option is available in System ⇒ Power Mode Standby menu.



Note:

- **OMS** and LAN control remote power on functions will only work when Power Mode Standby is set to **Active**.
- Active Standby mode consumes higher power since system only turns off backlight and mainboard is still working to listen for power on command from LAN and OMS. If you don't have remote power on requirement, we suggest using **ECO** Standby mode to save more power.
- It is also highly recommended that you switch back to **ECO** Standby mode and turn off the IFP for a period of time. It will help IFP system to release memory and CPU loading.
- Tap **Update** to configure upgrading options. Tap any of the following:

BASIC OPERATIONS



- **OTA (Over-The-Air) Software Upgrade** to enable or disable upgrading software over Internet. Enable **Check update when power on** and **Auto download** to check for firmware updates and download the updates (if available) every time the IFP is powered on and connected to the Internet. If the **Check update when power on** option is disabled, the system will not check for firmware upgrades automatically.

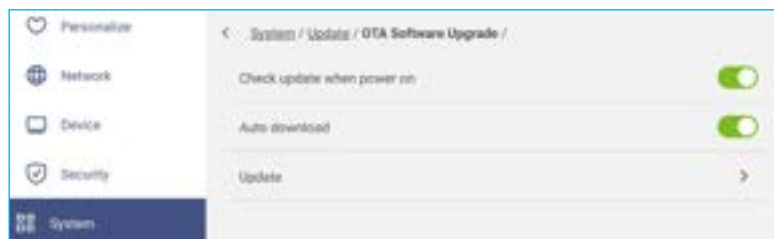

To update the system manually, tap **Update** and follow the onscreen instructions to complete the upgrade process.

Note: *Upgrading software over Internet requires network connection.*

- **USB Software Upgrade** to update the system from a USB flash disk.

Note: *To proceed with upgrading software, save the upgrade file to the USB flash disk first, then connect the disk to a USB 2.0 port on the IFP. Open Advanced Settings ⇒ System ⇒ Update ⇒ USB Software Upgrade and tap **Start** at the prompt.*

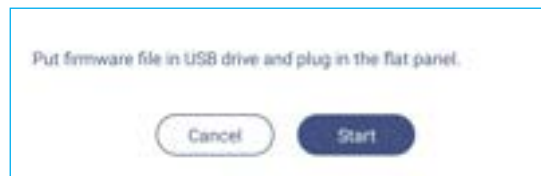

Note: *If you upgrade IFP's firmware from a USB storage, uncompress the upgrade file first and then copy the uncompressed file to the USB root directory. Make sure the USB flash disk is formatted as FAT32.*

IMPORTANT!

- *During the update process, either OTA or from a USB storage, DO NOT power off the IFP and DO NOT remove the USB dongle from the IFP. Doing so will damage the system.*
- *If you update the IFP from a USB storage then all user data saved to the IFP storage will be wiped out. If you update the IFP over Internet (OTA) then all user data remains intact.*
- Tap **Legal** to view Terms and Conditions of Use, Privacy policy, Cookie policy, and Open Source Library.



BASIC OPERATIONS

Side Toolbar

Tap > or < on the left or right side of the screen to open the side toolbar.

Note: Drag > or < up or down on the screen to relocate it.

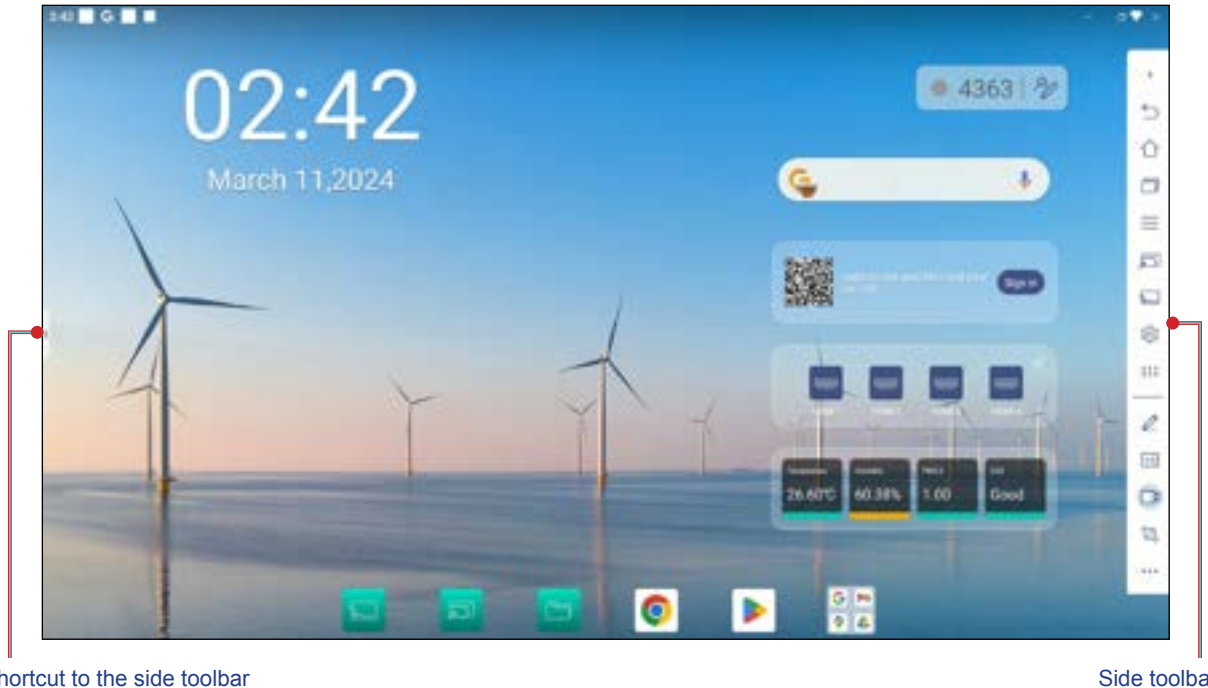

- To hide the toolbar, tap > or <.
- To return to the previous screen, tap ↶.
- To return to the Home screen, tap 🏠.
- To view recent or open tasks and apps, tap 🗄️. For more information, refer to “Viewing Recent Tasks” on page 59.
- To view the OSD menu, tap ≡. For more information, refer to “OSD Menu” on page 34.
- To open **Display Share**, tap 📺. For more information, refer to the “Display Share” section.
- To open **Whiteboard**, tap 📄. For more information, refer to the “Whiteboard” section.
- To open the Settings menu, tap ⚙️.
- To open the apps screen, tap 📱.
- To open the annotation app, tap ✎️. For more information, refer to “Annotation App” on page 60.
- To open Airshare, tap 📶. For more information, refer to “Airshare” on page 61.
- To open the screen recording tool, tap 📹. For more information, refer to page 37.
- To open the screen capture tool, tap 📷. Use this tool to capture the screen image and save it to the storage device or insert it into the whiteboard session. For more information, refer to “Screen Capture Tool” on page 66.
- To open more tools, such as **Freeze**, **Stopwatch**, **Timer**, **Spotlight**, **ScreenLock**, **PIP**, **Display center**, or **Calculator**, tap ⋮.

BASIC OPERATIONS

Viewing Recent Tasks

Tap > or <=>  to view and manage all opened apps.

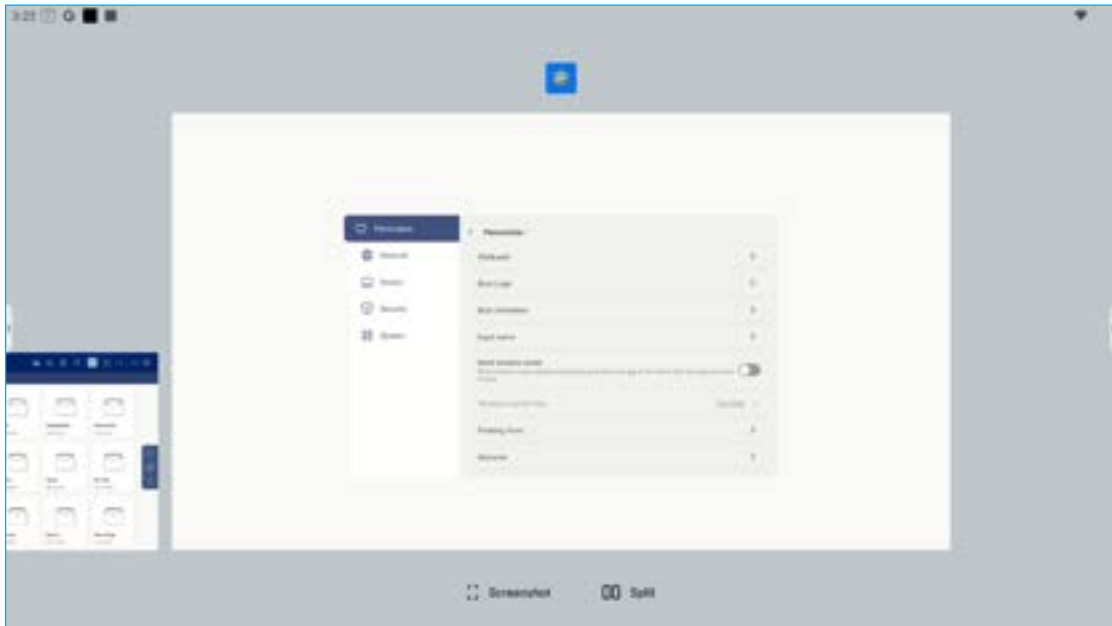

- Tap on the app you want to launch.
- To close the app, swipe the app window towards the upper edge.
- To clear the list, tap **Clear all**.
- Tap **Screenshot** to capture the screen image.
- Tap **Split** to view two apps in a split screen. Select one app first, next tap **Split**, and select the second app. To exit the split screen mode, tap on the center line of the apps and drag it to the left edge of the screen to open the right side app in a full screen or drag to the right side of the screen to open the left side app in a full screen.

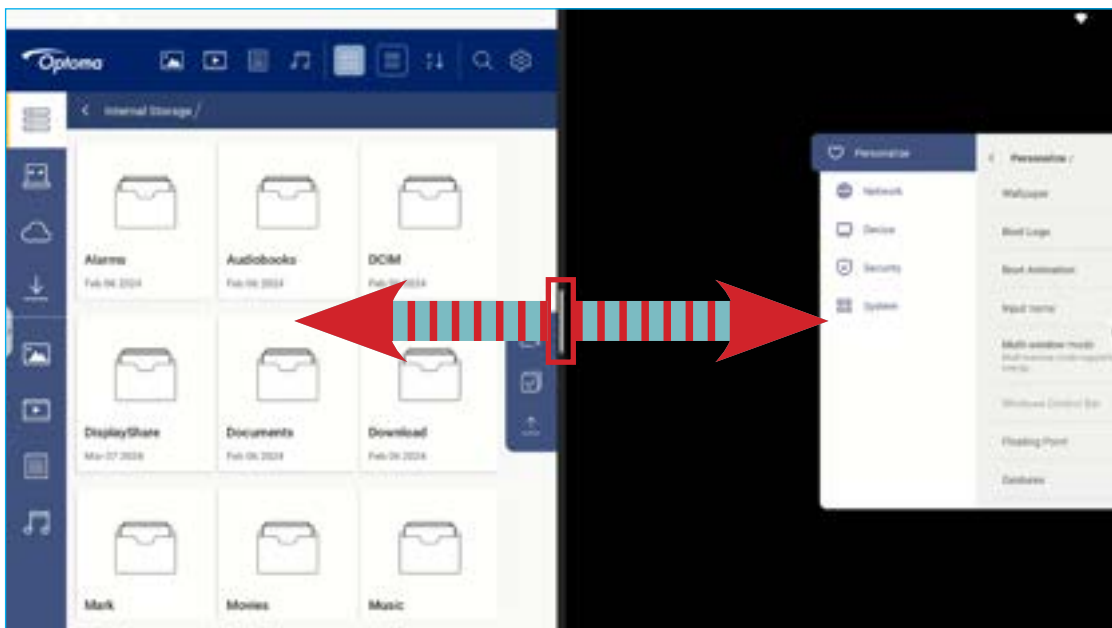

•



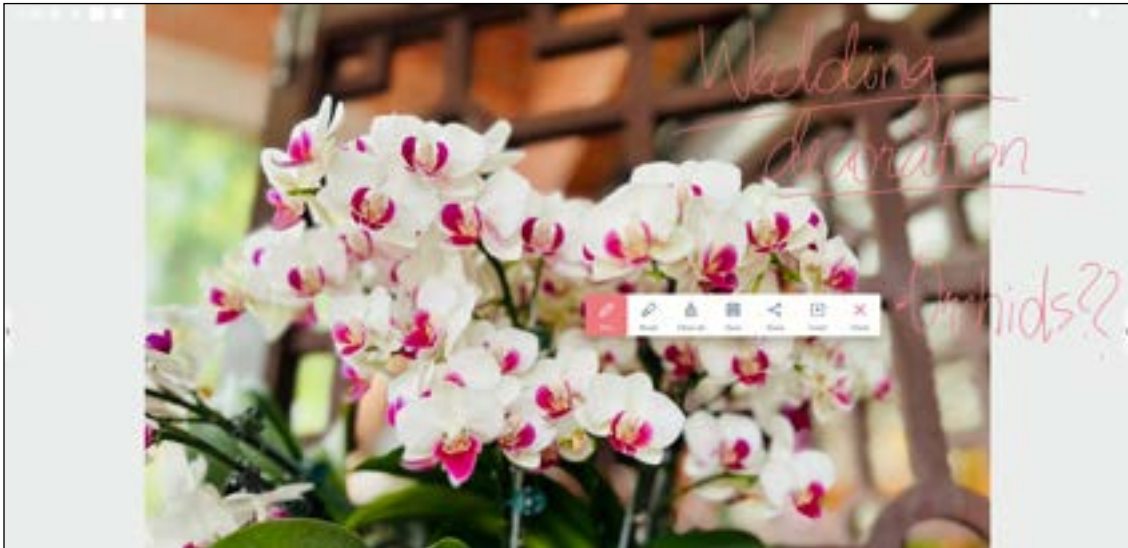

BASIC OPERATIONS

Annotation App



Tap > =>  to open the annotation app.





In this mode, you can do the following:

- Tap  to write and draw on the screen.
Note: You can change the pen color by tapping  repeatedly.
- Tap  to highlight the item on the screen.
Note: You can change the highlighter color by tapping  repeatedly.
- To erase all annotations on the screen, tap .
Note: You can also use the palm of your hand to erase the areas of your written texts or drawings.

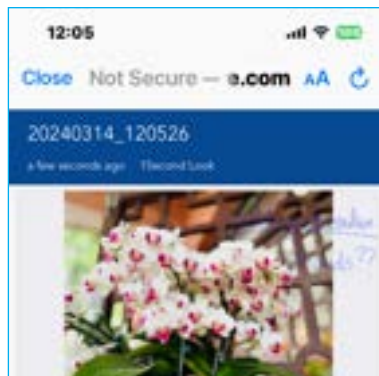

- To capture a screenshot of the entire screen, tap .
- To share the annotation to other wireless devices, tap . Make sure your wireless device is connected to the same Wi-Fi network as the IFP and then scan the QR code with your wireless device.





- Insert the annotation to the whiteboard session, tap .
- To exit the annotation mode, tap .

BASIC OPERATIONS

Airshare

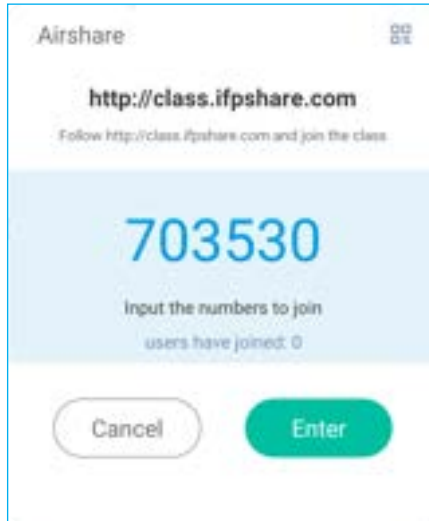
Tap > =>  to open **Airshare**. The online classroom access code and URL will be displayed on the screen.



- To display the connection QR code, tap .



To join the virtual classroom remotely, complete the following steps:

1. Connect the IFP to an available network.
2. On your mobile device, enable Wi-Fi function.

IMPORTANT! Make sure you have access to the Internet throughout the entire online session.

3. Open the classroom URL in a web browser and enter the access code or scan the access QR code. Then enter your name and tap **Enter** to join the class.



BASIC OPERATIONS

4. On the IFP, tap **Enter** to start the class session.

To participate in the class, do the following:

Launch the **Whiteboard** app. Then use the following functions:

a. Voter

1. Tap  to enter the Voter interface.
2. Select **Single choice** or **Multiple choice** to define the answer type.
3. Tap **Begin** to start answering the question.



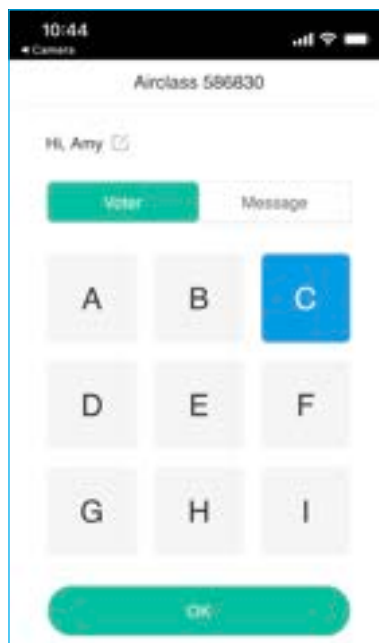

4. The participant can respond by selecting the answer on the mobile device screen and tapping **OK**.

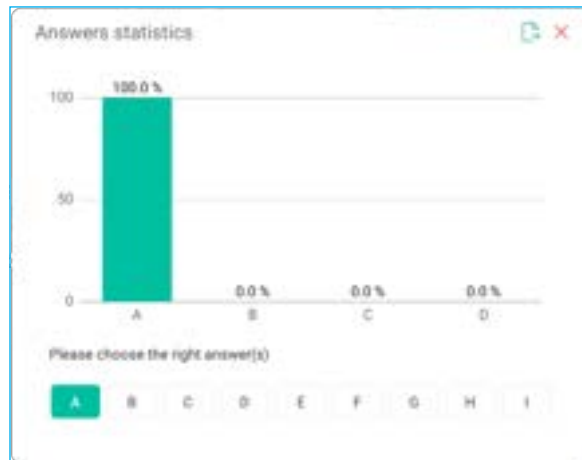

BASIC OPERATIONS

5. To close the answering session, tap **Finish**. The Answer statistics will be displayed on the screen.
6. Tap the right answer(s) on the statistics screen.



- Tap  to save and export the result.
- Tap  to close the Answer statistics page.

b. Responder

1. Tap  to enter the Responder mode. Then tap **Start** to start the answering mode.

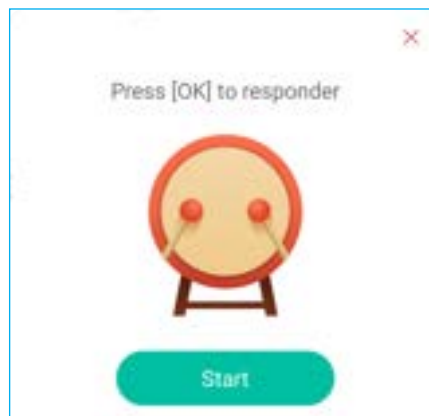

BASIC OPERATIONS

2. When the function is activated, the person who taps **Be fast** first will get the right to answer. For example, if Amy first taps **Be fast**, then she will get the right to answer the question.
 - Tap **Reset** to start the answering mode again.

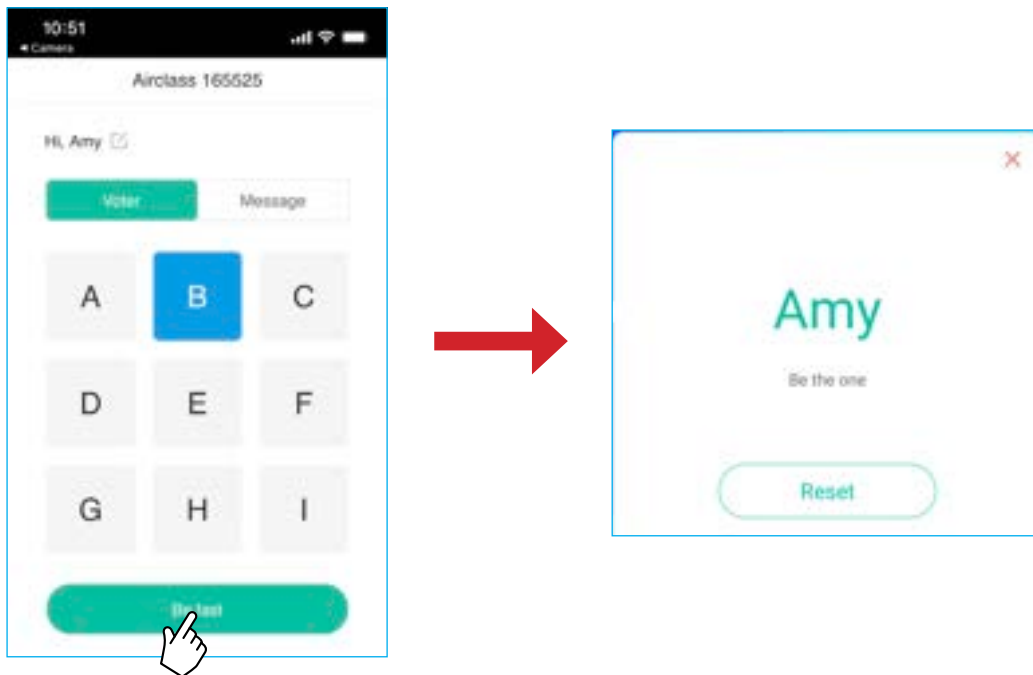

c. Selector

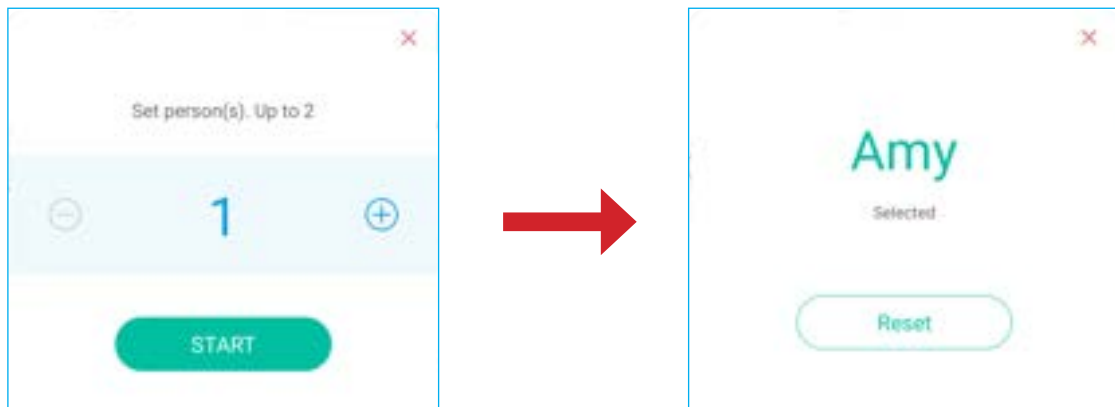

Tap  to enter the selector mode. Select the number of person(s) whom will be selected. Then tap **START**. The result is displayed on the screen.

- Tap **Reset** to select again.



BASIC OPERATIONS

d. Message

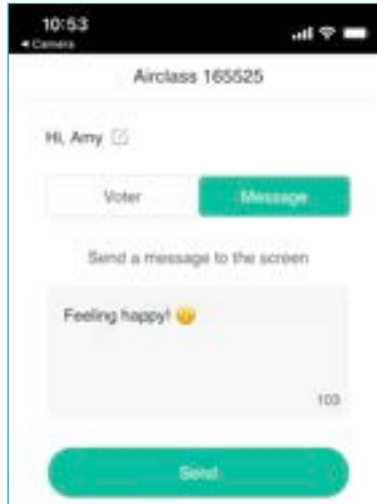

1. Make sure the message function is enabled  ⇒ .
2. On the mobile device, tap **Message** to switch to the Message screen, then enter your message in the comment text box and tap **Send**.

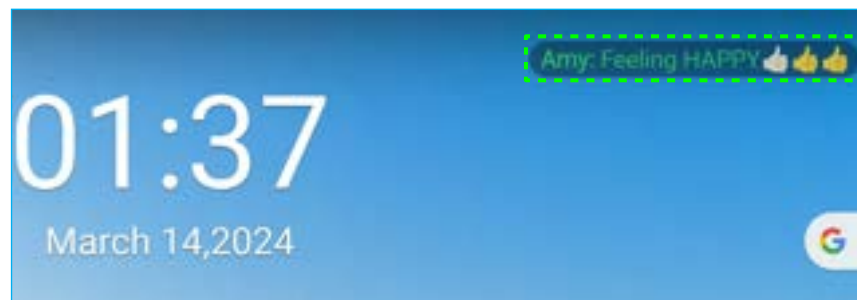

The broadcast message will appear on the IFP screen.



Note:

- Tap  to display the class access code, URL, QR code and allow more participants to join the class.
- Tap  to export the result.
- Tap  to exit **Airshare**. Confirm **Exit** at the prompt. All classroom users will be logged off.



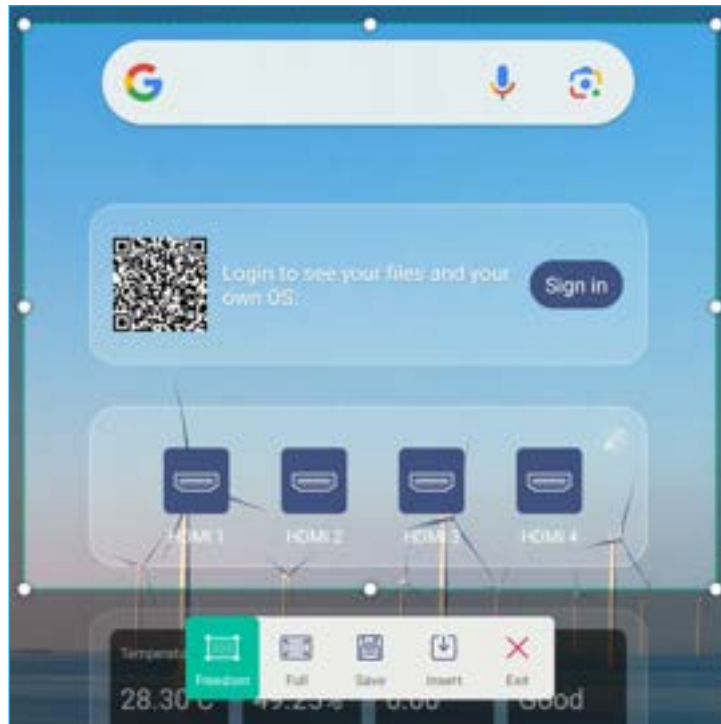

BASIC OPERATIONS

Screen Capture Tool

Tap > ⇒  to open the screen capture tool.



To capture the screen, do the following:









1. Tap either  or  to manually select the area or to capture the entire screen respectively.
2. Tap  to save the screenshot or tap  to insert the screenshot directly to the whiteboard session.
3. Tap  to exit the tool.

BASIC OPERATIONS

More Tools

Tap > => *** to access more tools such as **Freeze**, **Stopwatch**, **Timer**, **Spotlight**, **ScreenLock**, and **Calculator**.



- Tap **Freeze**  to freeze the screen. Then tap  to zoom in or tap  to zoom out. To restore the screen to its original size, tap . Finally, to exit the tool, tap .
- Tap  to use the **Stopwatch**.
- Tap  to use the **Timer**.
- Tap  to activate **Spotlight**. **Spotlight** can be used to direct the audience's focus to a specific part of the board.
- Tap  to lock the screen (**ScreenLock**). If the screen lock password is not set, you are prompted to set the password. Follow the onscreen instructions to complete the procedure.

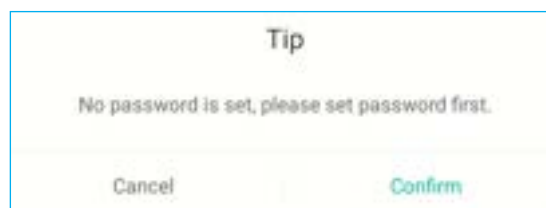



- Tap  to switch to the **PIP** mode. For more information on PIP mode, refer to page 36.

BASIC OPERATIONS

- Tap  to connect to a secondary display. Ensure to connect the other display to the HDMI out port on the IFP first and then configure the display settings. You can duplicate the display and rearrange the position.



- Tap  to use the **Calculator**.

To customize More tools icons in the side toolbar, tap $\gt \Rightarrow \dots \Rightarrow$ **Edit**. Then tap  next to the icon you want to remove from the side toolbar and tap  next to the icon you want to add to the side toolbar. You can add up to 4 icons to the side toolbar.

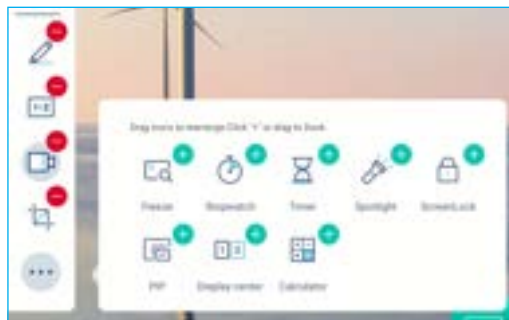







BASIC OPERATIONS

Floating Menu Toolbar

Touch and hold the screen with your two fingertips, a centimeter apart from each other. The floating menu toolbar opens.



- Tap  to return to the previous screen.
- Tap  to return to Home screen.
- Tap  to open **Whiteboard**.
- Tap  to open annotation app.
- Tap  to open the Settings menu.
- Tap  to view recent apps. Tap the app you want to switch to or tap  to close the floating menu toolbar.



- Tap  and drag the floating menu toolbar to your preferred location on the screen.

BASIC OPERATIONS

More Home Screen Features

Touch and hold on the Home screen to change the Home screen wallpaper & style, add widgets, and configure the screen settings.



- Tap **Wallpaper & style** to change the Home screen wallpaper, enable or disable dark theme, themed icons, configure accessibility, security, privacy, location, safety & emergency settings, manage passwords & accounts, digital wellbeing & parental control settings, Google services & preferences, system settings, and view device information.

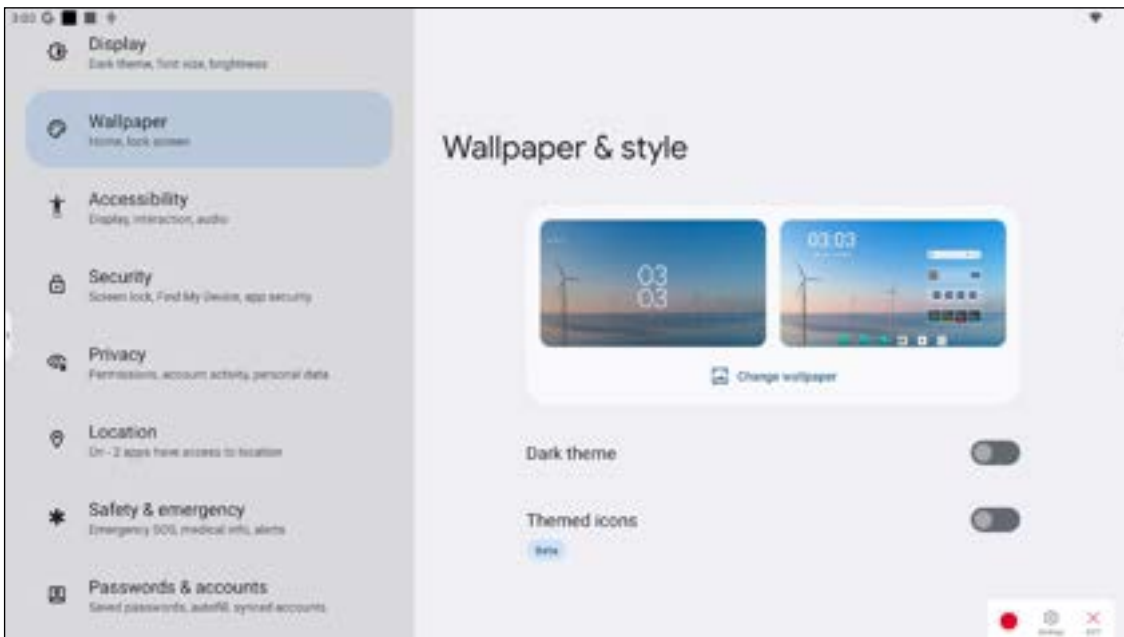

- Tap **Widgets** to add more widgets to the Home screen. You can search for a widget or select it from the list. To add the widget, touch and drag it to the Home screen.



BASIC OPERATIONS

Note: To remove the widget, touch and drag it towards the upper edge of the screen over the wording “Remove”.

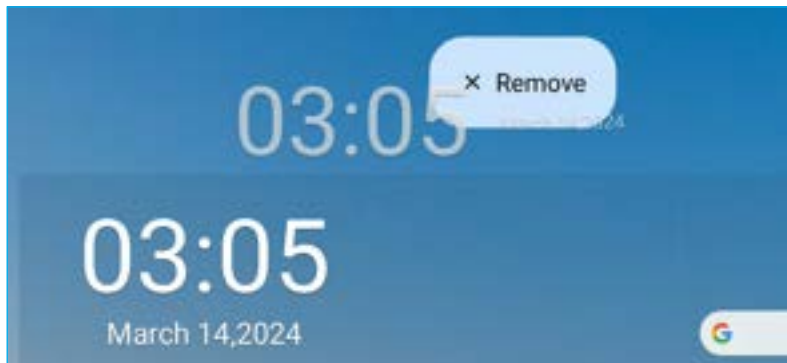

- Tap **Home settings** to enable or disable notifications dots and adding app icons to the Home screen.

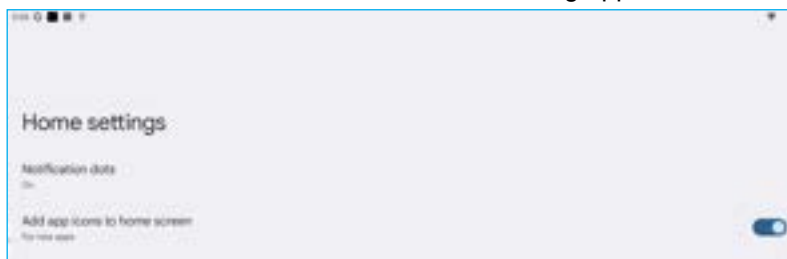

Quick Settings Panel

Swipe down from the upper edge of the screen to open the quick settings panel.

In the quick settings panel, you can adjust the screen brightness, access the basic settings, configure the account settings (👤), open the Settings menu (⚙️), power off or reboot the IFP (🔌), and read the notifications.

Note: To manage the basic settings panel, tap .

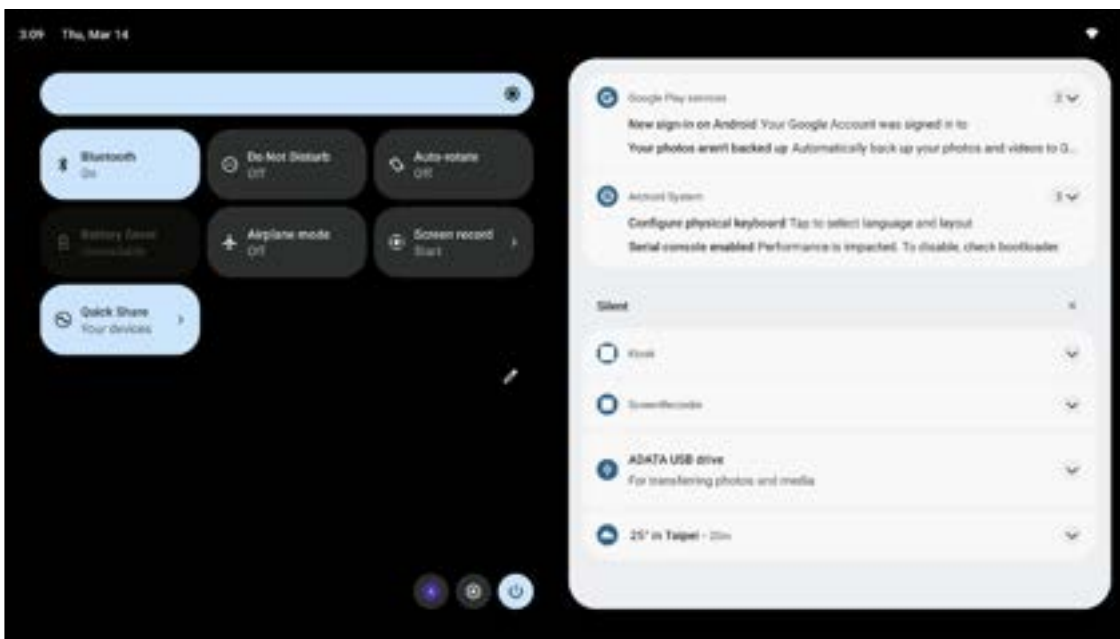

To close the quick settings panel, swipe it up towards the upper edge of the screen.

BASIC OPERATIONS

Manage the Source Shortcuts

To manage the source shortcuts on the Home screen, tap . You can add up to 4 source shortcuts. To modify the default shortcuts, first tap on the shortcut you want to remove and next tap on the shortcut you want to add. Those shortcuts that appear on the Home screen, are marked with the green circles. When finished arranging the shortcuts, tap **Save** to save the settings.

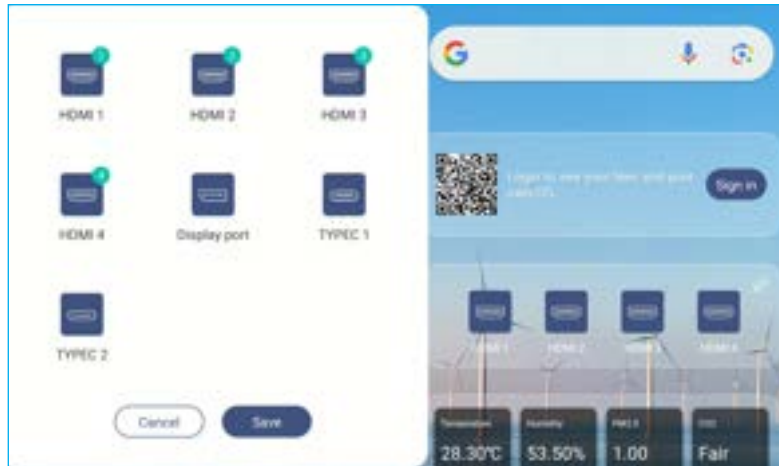

View the Sensor Panel

If the sensor box is installed and connected to the IFP, you can monitor the environment quality. To see sensor readings in a graph and export the results, tap on the sensor panel.



USING THE APPS

From the side toolbar, tap  or swipe up on the screen to view all the apps.

Note: To manually install a third party application, you have to enable the **Unknown sources** setting first in the **Security** ⇒ **Advanced Settings** menu. Refer to “Configuring Security Settings” on page 51.

You can then install the downloaded APK (Android Package) file into your system.

IMPORTANT! *Third-party Android apps can vary in quality and some may contain malicious codes, which could compromise system security and may invalidate product warranty. Optoma makes no representations regarding the quality, security or suitability of any third-party apps and their compatibility with the Optoma interactive flat panel. Optoma shall have no responsibility or liability with respect to any damage, faults, loss in functionality or security issues arising as a direct or indirect result of the installation of third-party apps on the interactive flat panel. Optoma support in rectifying any issue which may result from the installation of third-party apps will be chargeable and may be limited. Information is correct at the time of writing and is subject to change.*

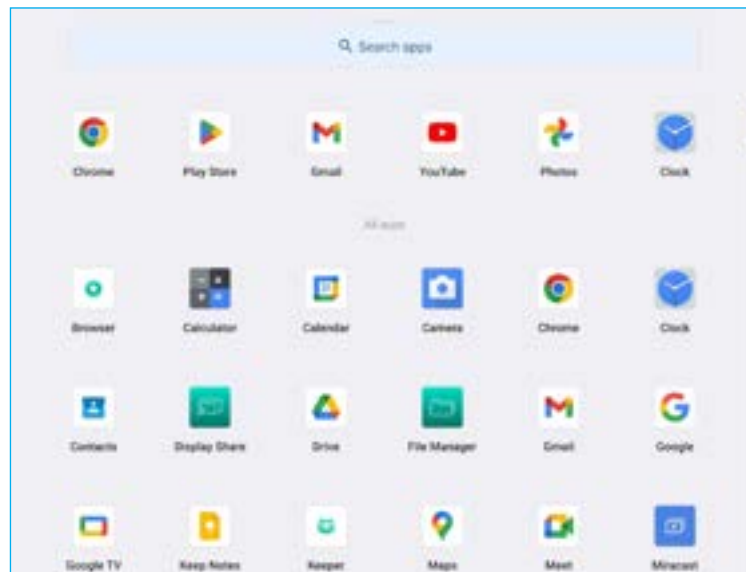



USING THE APPS

Whiteboard

Whiteboard is an online collaborative platform that can bring teams together to brainstorm, sketch and collaborate, anytime, anywhere.





Note: For more detail function introduction, please refer to <https://onlinemanual.optoma.com/whiteboard/>.

Tap  on the Home screen or  in the side toolbar to open the **Whiteboard**.









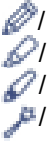

To start using the app, do the following:



1. Tap on the **Create new session** tab. Then select a background or template for your content.
 - Note:** To access your cloud sessions, login to **Whiteboard** first.
 - To open a recent session, tap on the **Home** tab and under Recent category tap on the session you want to continue.
 - To open a collaboration (saved to the cloud) or non-collaboration (saved locally) session, under Your session category, tap on the session you want to continue.
2. Tap **Create** and use any of the activities described in the table below:
 - Note:** The floating toolbar is home to many of the primary features found in the **Whiteboard** app, which are detailed here.

Item		Description
	Move the floating toolbar	Tap and drag or long-tap on the screen to move the floating toolbar to your preferred location on the screen. 
	Minimize the floating toolbar	Tap on the  icon to minimize the floating toolbar. Tap  to expand the floating toolbar.







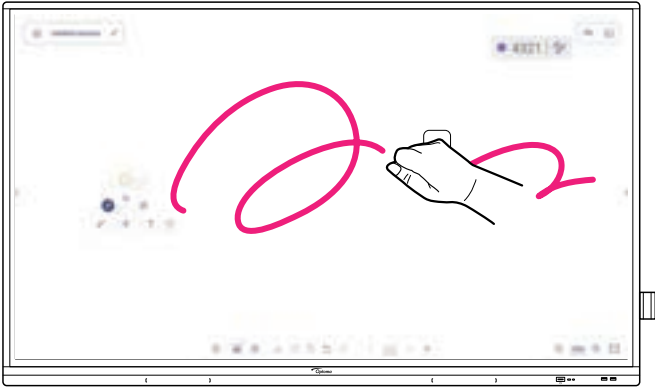













USING THE APPS

Item	Description
 <p>Pen-tip options</p>	<p>Write or draw a freeform line. Tap to select the desired line color and thickness.</p>  <p>- To show more pen-tip options, tap on the  to expand and view all available options.</p>  <p>- Tap  to modify the color palette. You can select five palette colors based on the theme or select them individually.</p>  <p>IMPORTANT! Avoid damaging the virtual whiteboard. For writing and drawing, use ONLY the supplied touch pen or your fingers.</p> <p>Note:</p> <ul style="list-style-type: none"> • Touch pen is supplied with thin tip and thick tip. Whiteboard can detect automatically which tip (/  accordingly) you are using and displays the options based on the tip thickness. • If you are using your fingers to write or draw on the virtual whiteboard then it is considered as using a “thick tip pen”.





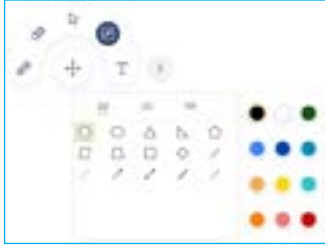

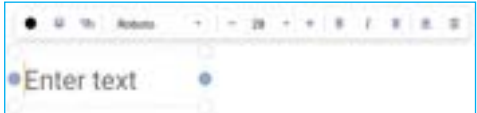













USING THE APPS

Item	Description
 Eraser	<p>Erase areas of your written texts or drawings. Select the eraser size and drag your fingers over the area you want to remove.</p>  <p>Note: You can also use the palm of your hand to erase the item on the whiteboard.</p> 





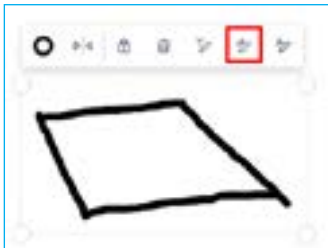



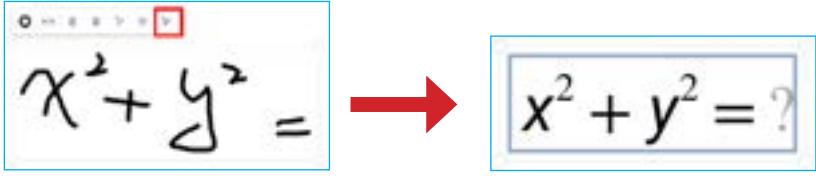

USING THE APPS

Item	Description
 Select	<p>Select an object on the whiteboard. Tap any of the following to alter the selected area:</p>  <ul style="list-style-type: none"> •  (boundary point) enlarge or shrink. •  use free rotation. •  change the color. •  arrange the object. Bring to front () or send to back (. •  rotate 90 degrees. •  assign a hyperlink. •  lock the object and location. •  delete. •  detect symbols. •  detect functions. •  cut. •  copy. •  paste.
 Geometric shape	<p>Draw a geometric shape. Tap to select the desired 2D, 3D shape with several color options, use a ruler to measure distances and draw lines, or use a protractor to measure and draw angles.</p> 
 Text editor	<p>Open the text editor and add text.</p> 





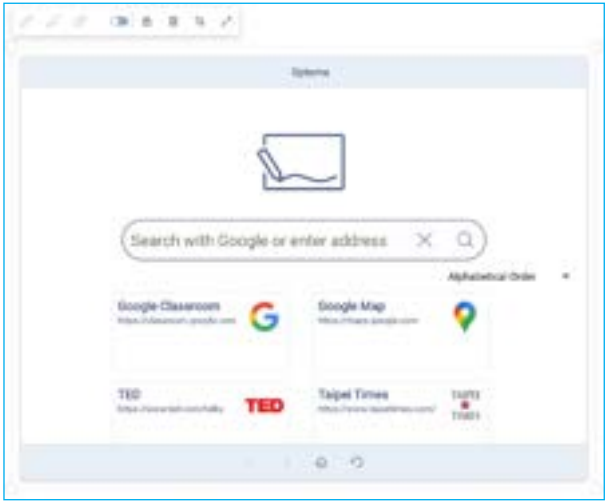

USING THE APPS

Item	Description
Automatic recognition	<p>Whiteboard can recognize your handwriting or drawing and can convert it into a digital format.</p> <ol style="list-style-type: none"> Write or draw on the screen. Use the select tool  to select the text or drawing. The following pop-up menu opens: <div data-bbox="778 495 1107 544" style="border: 1px solid black; padding: 2px; display: inline-block; margin: 5px 0;">       </div> Tap any of the following: <ul style="list-style-type: none">  change the color.  rotate 90 degrees.  lock the object and location.  delete.  detect symbols. Select the handwritten text and tap  to accept it or tap  to reject it. <div style="display: flex; justify-content: space-around; align-items: center; margin: 10px 0;"> <div data-bbox="534 918 863 1158" style="border: 1px solid black; padding: 5px;">  </div> <div data-bbox="877 1008 989 1075" style="font-size: 2em; color: red;">→</div> <div data-bbox="1023 918 1351 1243" style="border: 1px solid black; padding: 5px;"> <div style="border: 1px solid gray; padding: 5px; margin-bottom: 5px;">Good</div> <div style="border: 1px solid gray; padding: 5px; margin-bottom: 5px;">Good</div> <div style="border: 1px solid gray; padding: 5px; margin-bottom: 5px;">Goed</div> <div style="display: flex; justify-content: space-between; align-items: center;">  <div style="border: 1px dashed gray; padding: 5px; font-size: 1.5em; font-weight: bold;">Good</div>  </div> </div> </div> <ul style="list-style-type: none">  detect a geometric shape. <div style="display: flex; justify-content: space-around; align-items: center; margin: 10px 0;"> <div data-bbox="534 1299 863 1545" style="border: 1px solid black; padding: 5px;">  </div> <div data-bbox="877 1433 989 1500" style="font-size: 2em; color: red;">→</div> <div data-bbox="1023 1388 1351 1545" style="border: 1px solid black; padding: 5px;">  </div> </div>



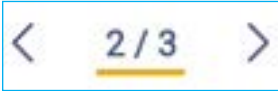











USING THE APPS

Item	Description
Automatic recognition	<ul style="list-style-type: none">  detect the function. 
 More tools	<p>Tap any of the following tools:</p>  <ul style="list-style-type: none">  search for Google images or Youtube videos and embed the results onto the whiteboard.  add a note () or multiple notes () onto the whiteboard.  embed a fully functional web browser window. You can lock the position of the browser window, capture screenshots, resize, relocate, delete it, and more.  <ul style="list-style-type: none">  embed a document camera.
	Add a page.

USING THE APPS

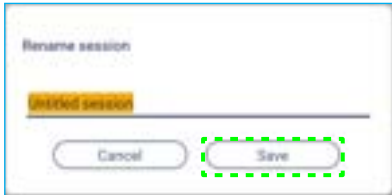

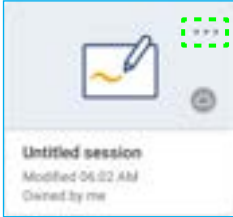





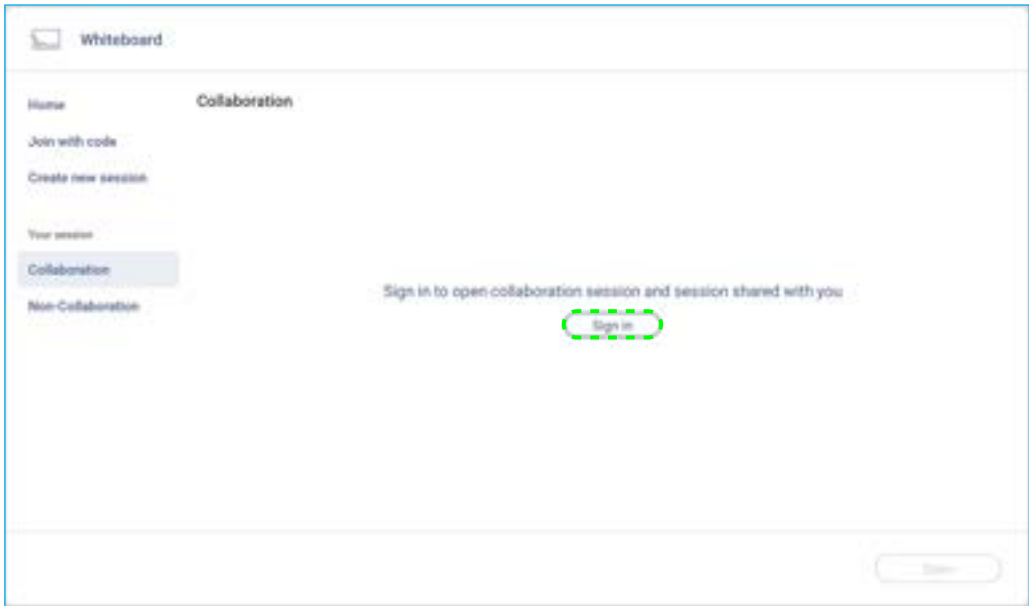

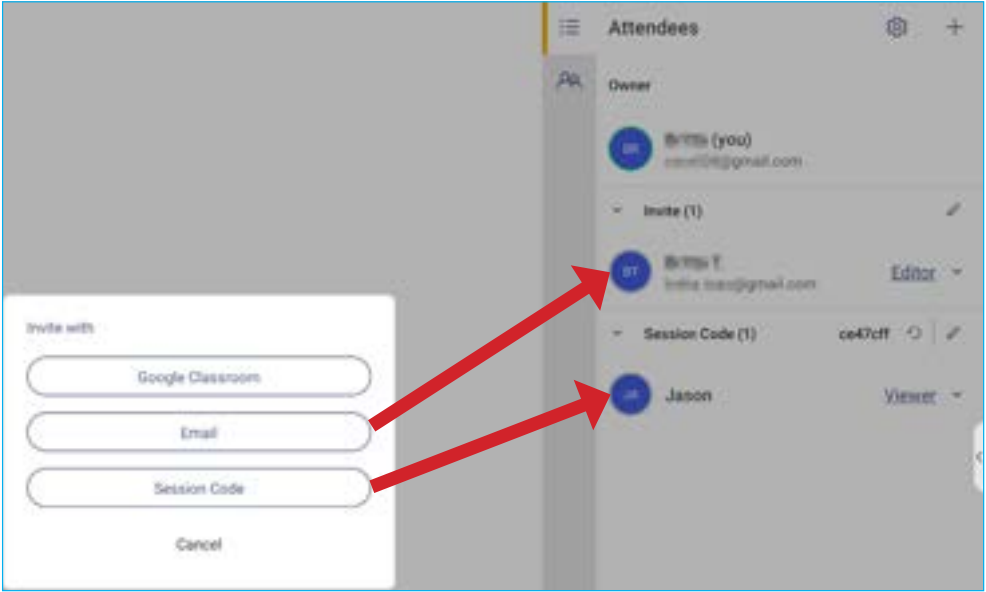

Item	Description
 Menu	<p>Tap any of the following options:</p> <ul style="list-style-type: none"> • New to create a new session. • Open to open a collaboration or non-collaboration session. • Save/Save As to save/save as the current content to collaboration or non-collaboration session. • Import to import a JPG, PNG, or PDF file. • Export to export the session as JPG, PNG, or PDF file. • Settings to open the Whiteboard Settings menu. Then enable or disable auto saving for non-collaboration session, eye protection writing mode, palm rejection, customize floating toolbar, and update software. • Tutorial to review the Whiteboard tutorial. • Share to share the whiteboard session by QR code or email. <p>Note: To share the whiteboard session by the QR code, make sure the other device is connected to the same Wi-Fi as the IFP.</p>
 Background options	<p>Select a background color (🎨) or apply a template (📄) to your session. You can also download an image to your session from a storage or upload the current screen as an image to your storage.</p>
 Page manager	<p>View and manage all pages that are involved in the current session. Tap any of the following:</p> <div data-bbox="805 1088 1083 1178" style="border: 1px solid blue; padding: 5px; margin: 10px auto; text-align: center;">  </div> <ul style="list-style-type: none"> •  to open the previous or next page. • Page number, for example 2/3 to open the page manager: <div data-bbox="429 1294 1460 1572" style="border: 1px solid blue; padding: 10px; margin: 10px auto;">  </div> <p>Tap  on the left side to add a page to the left or on the right side to add a page to the right.</p> <p>Tap  to delete the selected page.</p>

USING THE APPS

Item	Description
 Zoom	<p>Zoom in or zoom out on the screen. Then tap  to open the zoom preview window. Move the red box to the area that you want to show on the screen or tap  and use your two fingers to move the object on the screen to your preferred location. While in the preview mode, you can also zoom in and out on the object by pinching the screen.</p>  <p>Tap  to close the zoom preview window.</p>
 Delete a page	<p>Delete all items/objects you draw in current page.</p>
 Undo	<p>Undo your last action.</p>
 Redo	<p>Redo your last action.</p>
<p>Session name</p>	<p>The default session name is “Untitled session”.</p>  <p>Note: Tap  next to the session name to access the Whiteboard launcher page. To rename the session, tap  and type in a new name at the prompt. Then tap Save.</p>  <p>Note:</p> <ul style="list-style-type: none"> You can also rename the session on the Whiteboard Home tab. Select the session and then tap  ⇒ Rename. Tap Save at the prompt to save the modifications.  <ul style="list-style-type: none"> If the session is marked with the  icon then it means it is an active collaboration session and if the icon is  then it means it is a inactive collaboration session. All other sessions are non-collaboration sessions. To access collaboration sessions, make sure to be logged in to Whiteboard.

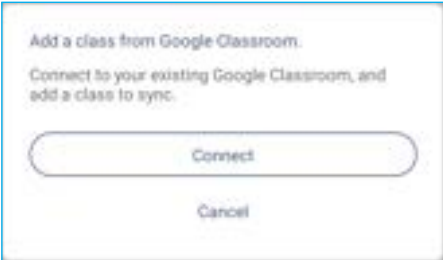

USING THE APPS

Item	Description
Sign in	<p>Sign in to Whiteboard with your Whiteboard or Google account to create or open existing collaboration sessions. Open the Collaboration tab on the Whiteboard launcher page. Then tap Sign in.</p>  <p>The screenshot shows the Whiteboard app launcher interface. At the top, there is a 'Whiteboard' header with a home icon. Below this, there are two tabs: 'Home' and 'Collaboration'. Under the 'Collaboration' tab, there are three options: 'Join with code', 'Create new session', and 'Your session'. The 'Your session' section is expanded, showing 'Collaboration' and 'Non-Collaboration' options. A central message reads 'Sign in to open collaboration session and session shared with you'. A 'Sign in' button is highlighted with a green dashed circle. At the bottom right, there is a 'Done' button.</p>

Item	Description
 Attendees management	<p>Invite attendees to join the Whiteboard session.</p> <p>On the Attendees tab , tap  and then select any of the following options:</p>  <ul style="list-style-type: none"> • Google Classroom • Email • Session Code <p>On the Attendees tab you can assign a role to the attendee (either viewer or editor), delete ( ⇒ ) attendees, renew () the session code, and configure () attendee settings.</p> <p>Tap  to access the Group tab. Then tap  and enter the group information, such as group name and attendees. Tap Save.</p>  <p>To modify group settings, tap .</p>
 Google Classroom management	<p>Tap Connect to connect to your existing Google Classroom, and add a class to sync.</p> 

USING THE APPS

Display Share





Tap  on the Home screen or  in the side toolbar to start wireless sharing and projection via Wi-Fi or LAN.

Note: For more detail function introduction, please refer to <https://onlinemanual.optoma.com/displayshare/>.

IMPORTANT!

- The IFP and your mobile device/computer must be connected to the same Wi-Fi or LAN network.
- While in use, make sure that you have access to the Internet.

Supported Operating Systems for Casting

Display Share Senders	Available Version
 Windows	Windows 8, 8.1, 10, 11 and above
 Mac	MacOS 10.12 and above
 iPhone	iOS 14 and above
 Android	Android 9.0 and above
 Chrome	Chromebook OS V74 and above

Proprietary Sharing

Features	Operation System
Web Sharing (Web Sender)	Chrome Browser
AirPlay Support	iOS 14 and above
ChromeCast	

USING THE APPS

Mobile Device

When the setup guide screen appears, scan the QR code to download and install the **Display Share** app onto your mobile device.

Note: You can also download the **Display Share** app from <https://www.optoma.com/displayshare> website.

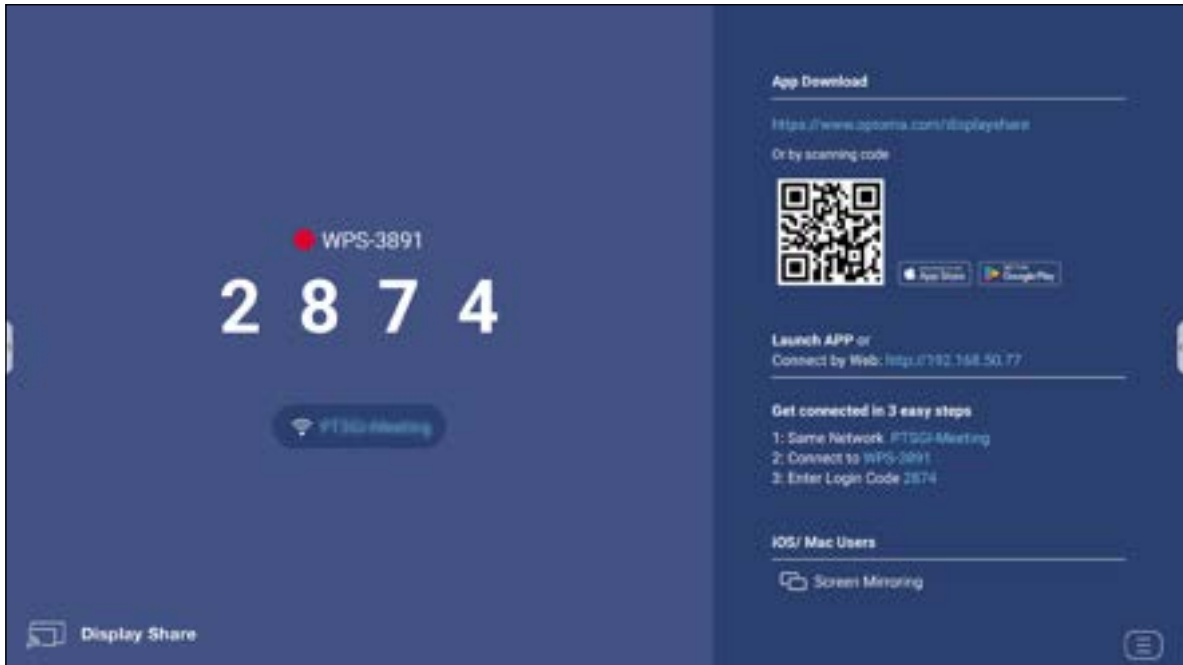

To connect to the IFP, complete the following steps:

Note: The connection steps are described based on an iOS device.

1. Launch the **Display Share**  app. Select the device and then tap **Start Broadcast**.

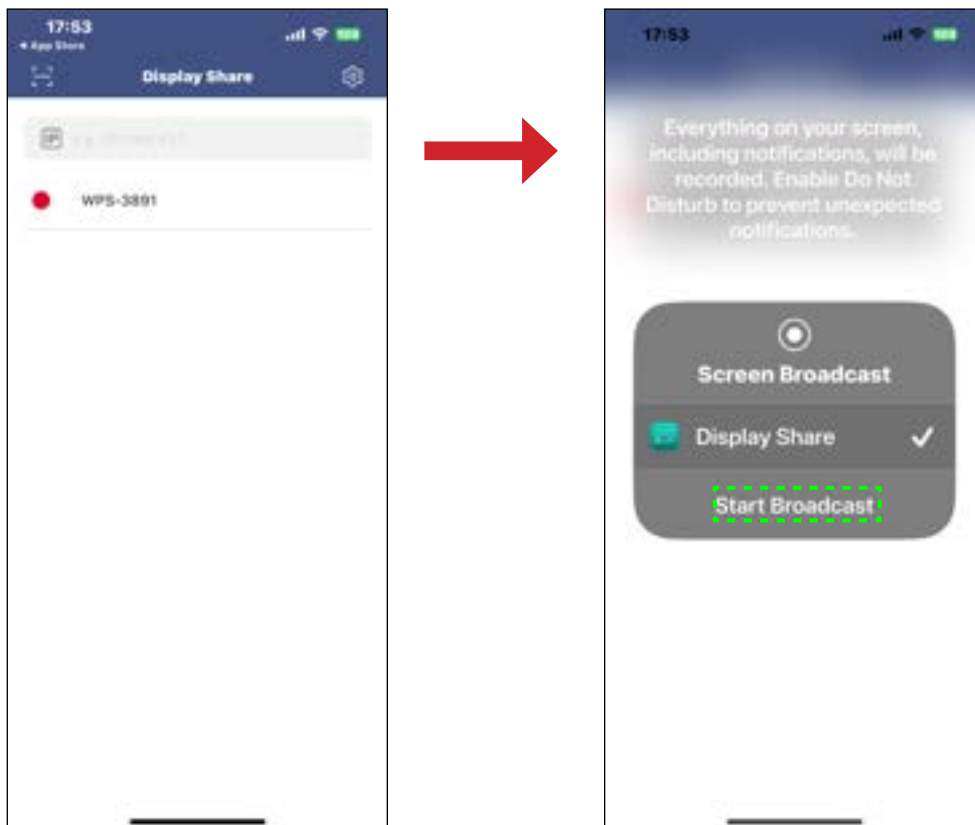

USING THE APPS

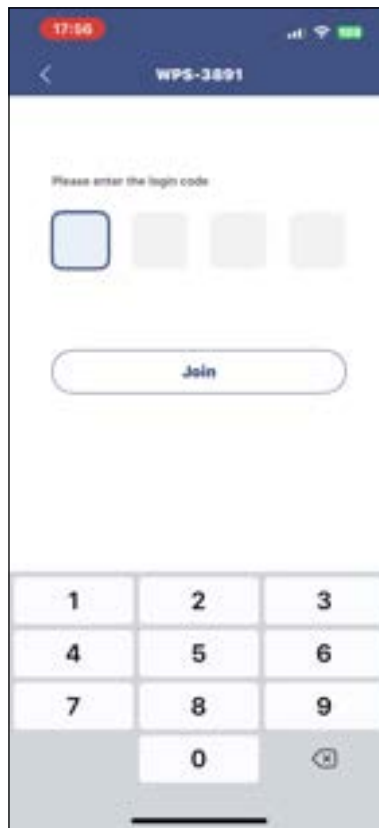

2. Enter the **login code** from the launcher screen and tap **Join**.

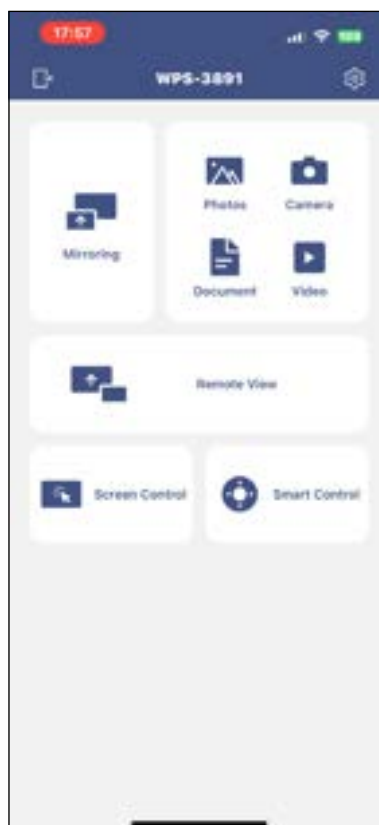

3. Tap any of the following:



USING THE APPS

- **Mirroring** to mirror your mobile device's screen to the IFP.
 - **Photos** to view and share photos.
 - **Camera** to stream your mobile device's camera to the IFP.
 - **Document** to view and share documents.
 - **Video** to view and share videos.
 - **Remote View** to mirror the IFP screen to your mobile device with annotation and image saving feature.
 - **Screen Control** to mirror the IFP screen to your mobile device. You can use your mobile device to operate the IFP.
 - **Smart Control** to use your mobile device as a remote control to control the IFP.
 - **Settings**  to modify your mobile device's user name, view the **Display Share** version, and read the Open Source License.
4. To stop the screen broadcast, tap .



Computer

You can mirror the screen of your computer via Chrome browser or **Display Share**. To use either of these options, open the browser and enter the IP address that is displayed on the launcher screen into the URL field. For example, <http://192.168.50.77> or download and install **Display Share for Windows**.

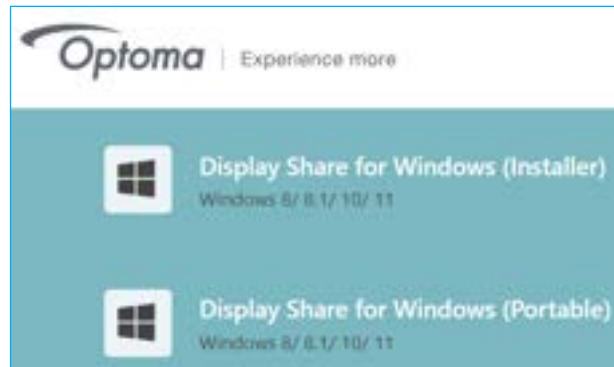

USING THE APPS

To start screen casting, download **Display Share** to your computer.

1. Launch the **Display Share** app and click on the device.
 - If the IFP is not visible in the Room List, input the IFP's IP address manually to the Input IP address field. Press **Enter** to start searching for the device.



2. Enter the login code from the launcher screen and click **Join**.



3. Click any of the following:



- **Mirroring** to mirror your computer's screen to the IFP.
- **Remote View** to mirror the IFP screen to your computer with annotation and image saving feature.
- **Settings**  to change the username, view the **Display Share** version, and read the Open Source License.

USING THE APPS

- **Moderation Mode**  to start moderator management of the screen sharing. Enter your password and click **Start**.



Note: To modify the admin password, refer to “Display Share Configuration” on page 90.

You can select up to 4 screens to display on the IFP. To exit the moderation mode, click **Leave** and then click either **Disconnect All** or **Leave the Room**.

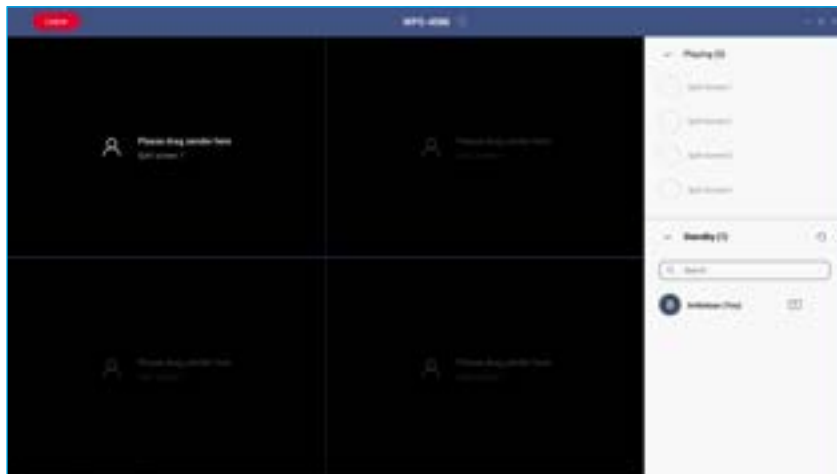

4. To exit the **Display Share** app, click .



USING THE APPS

Display Share Configuration

Tap  to open the Display Share menu.



Tap on any of the following icons to configure the **Display Share** settings:

- **Annotation** : Open the annotation tool.
- **Grouping** : Share the screen to other devices.
- **Settings** : Manage the general and moderator settings, view the **Display Share** app version, and read the Open Source License. Tap on any of the following categories to configure the settings.
 - General tab: Modify the device name, view connectivity information, select the login code renewal pattern, enable or disable the floating window and the availability of **Airplay**, **Chromecast**, and **Miracast** apps.

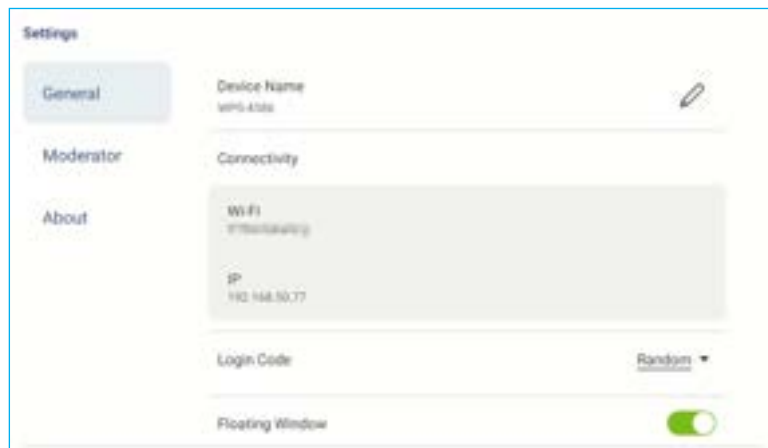

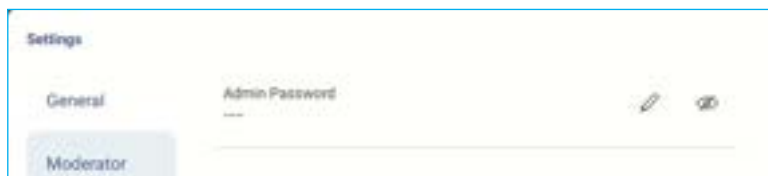

- Moderator tab: Modify the admin password.

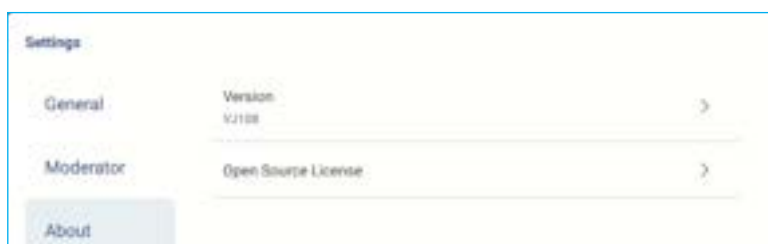

- About tab: View the **Display Share** app version and read the Open Source License.





USING THE APPS

- **End session** : End the session and disconnect all the connected devices.
- **Close** : Close the menu.

USING THE APPS







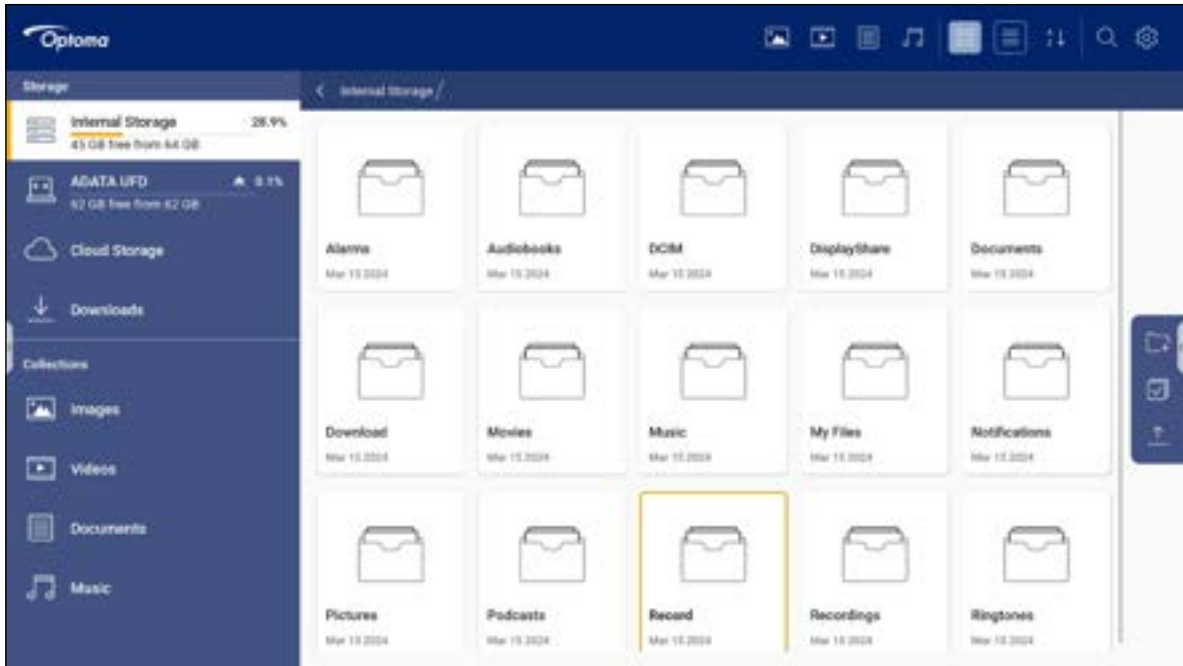



File Manager

Tap  on the Home screen or  =>  in the side toolbar.















Managing Files



Select a storage location and browse for a file or folder you want to view then tap twice on a file or folder to open. The table below will help you navigate **File Manager** and its included features.

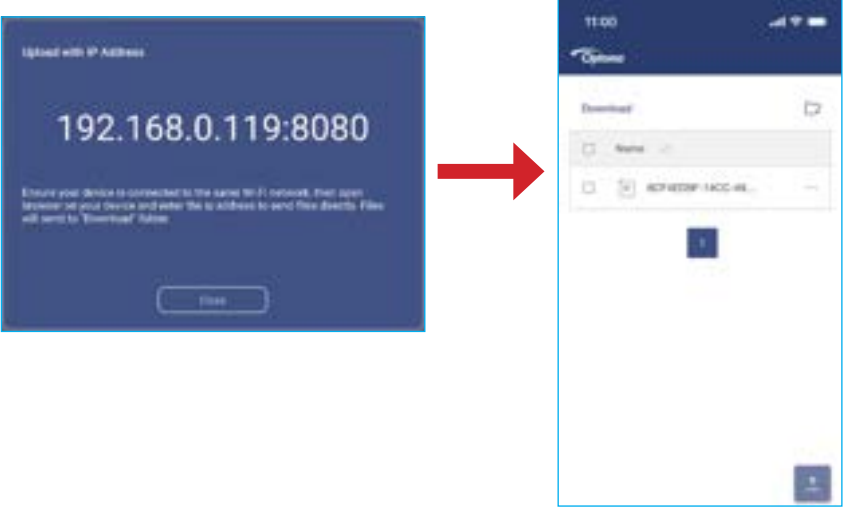

Item	Description
 Images	Display only image files in the selected storage location.
 Videos	Display only video files in the selected storage location.
 Document	Display only document files in the selected storage location.
 Music	Display only audio files in the selected storage location.
 Thumbnail view	View files and folders as thumbnails.
 List view	View files and folders as a list.
 Sort	Sort files and folders by name or by date in ascending or descending order.
 Search	Search files and folders using key words or names.
 Software version	View software version and update app (if necessary).
 New Folder	Add a new folder.

USING THE APPS

Item	Description
 Select	<p>Select files and folders. When selected, tap any of the following:</p> <ul style="list-style-type: none">  undo your last action.  check/uncheck all items.  cut and paste item(s).  copy and paste item(s).  delete item(s).  rename an item.  share an item via QR code. <p>Note: For file sharing via QR code, make sure your mobile device is connected to the same network as the IFP.</p> <div style="text-align: center;">  </div> <ul style="list-style-type: none">  compress item(s).  move/copy item(s) to another location or view item details.
 Share item(s)	<p>Share item(s) between the IFP and your mobile device over web browser.</p> <div style="text-align: center;">  </div> <p>Note:</p> <ul style="list-style-type: none"> By default, all items that you upload to the IFP are saved to Download  folder. For item(s) upload, make sure your mobile device is connected to the same network as the IFP.

USING THE APPS

Cloud Storage

Tap **File Manager**  ⇒ **Cloud Storage**  to create an account or use an existing account to access your cloud storage.

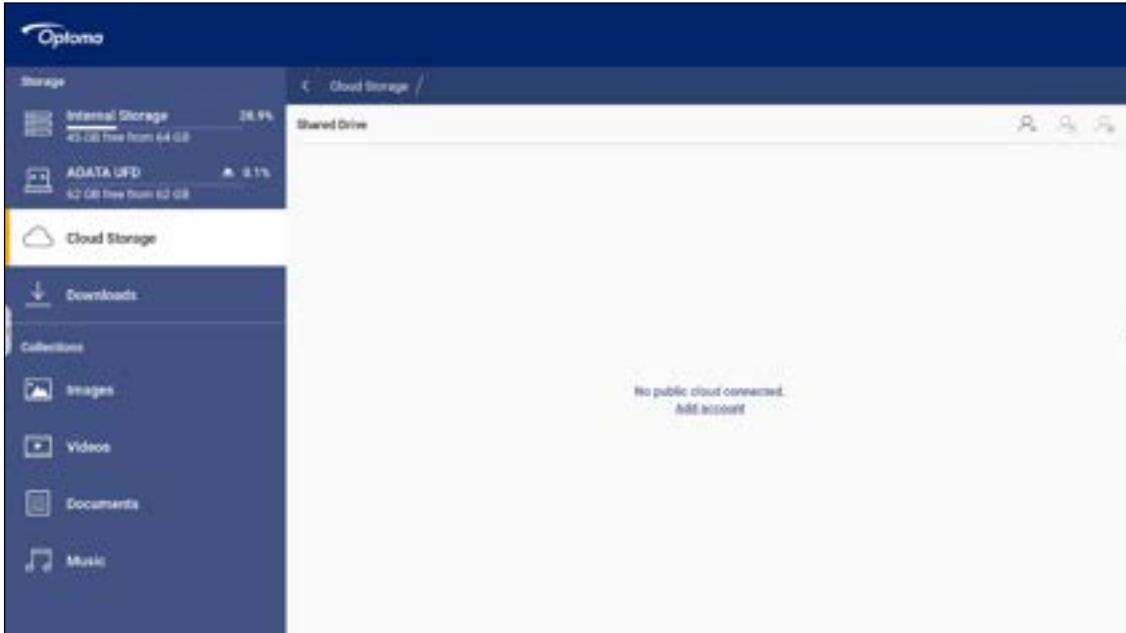

To create an account:

1. Tap  or **Add account**.
2. Select the drive type.



3. Follow on-screen instructions to create an account or sign in to your existing account.
4. After successful login, you are prompted to set a security PIN. Tap **Setup** to set the PIN or **Skip** to skip this step.

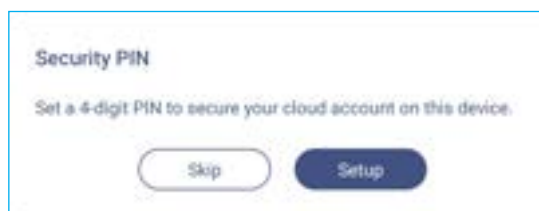



Note: PIN code is used to protect user's cloud storage from being illegally accessed. When system status changes (for example, from standby to normal, from backlight off to on), a user must key in the PIN code the set up for verification in order to access their cloud storage..

USING THE APPS

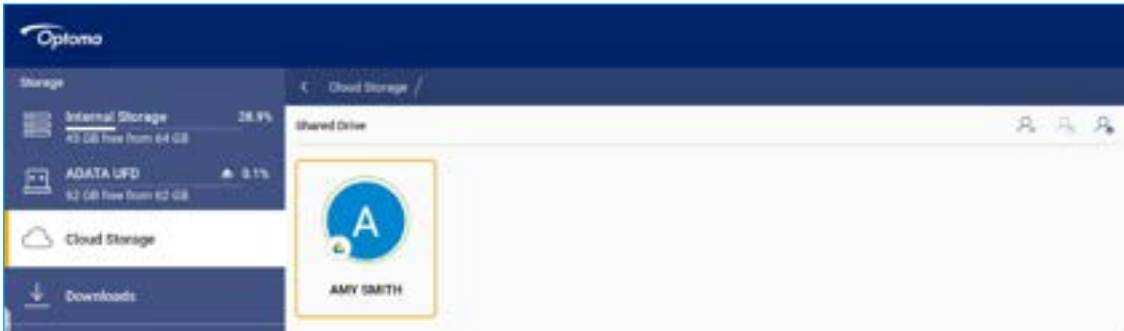
Your account will be listed in the **Cloud Storage** menu.



5. To manage your cloud storage account(s) in the **File Manager**, tap any of the following:

-  to add another cloud storage account.
-  to lock the cloud storage account.
-  to delete the cloud storage account.

Note: Locking and deleting the cloud storage account in the **File Manager** will only prevent or remove access to that cloud storage in the **File Manager** and will not lock or delete the cloud storage in its original location, for example in Google.

To add PIN security to cloud account if skipped during setup, follow these steps:

1. Select **Setup** to set the PIN.

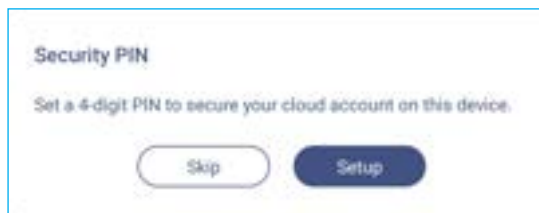

2. Enter a PIN code (4-digit number) in the *Enter a new PIN* field. Then enter again the new PIN code in the *Enter the PIN again* field.

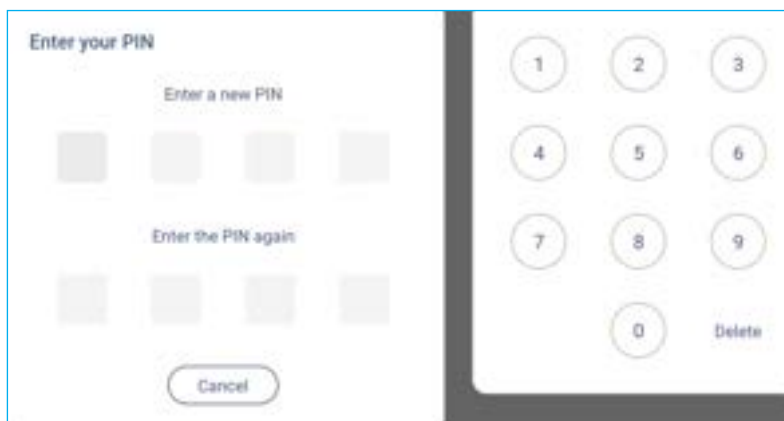

USING THE APPS

Note: You only have to enter the PIN code once after successful login.

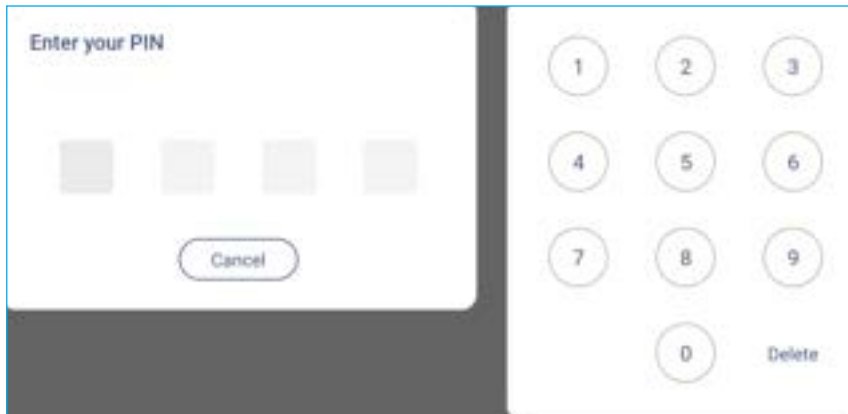

Playing Multimedia Files

Multimedia formats supported

Movie

File	Codec		
	Extension	Video	Audio
.3gp/3GP2	H.263	Mpeg1/2 Layer1/2/3, AAC-LC, PCM	Max. solution: SQCIF(128x96), QCIF(176x144), CIF(352x288), 4CIF(704x576) 30fps, 38.4Mbps
	H.264		Max. solution: 7680x4320 30fps (60fps for simple stream), 80Mbps
.avi	H.264	Mpeg1/2 Layer1/2/3, AAC-LC, PCM	Max. solution: 7680x4320 30fps, 80Mbps
	Mjpeg		Max. solution: 1920x1088 30fps, 45Mbps
.dat	mpeg1/2	Mpeg1/2 Layer1/2/3	Max. solution: 1920x1088 30fps, 38.4Mbps
.flv	H.264	Mpeg1/2 Layer1/2/3, AAC-LC, PCM	Max. solution: 7680x4320 30fps (60fps for simple stream), 80Mbps
.mkv	Mpeg-4	Mpeg1/2 Layer 2, AAC, FLAC, Vorbis	Max. solution: 1920x1088 30fps, 80Mbps
	H.264		Max. solution: 7680x4320 30fps (60fps for simple stream), 80Mbps
.mov	Mpeg-4	Mpeg1/2 Layer1/2/3, AAC-LC, PCM	Max. solution: 1920x1088 30fps, 80Mbps
	H.264		Max. solution: 7680x4320 30fps (60fps for simple stream), 80Mbps
.mp4	Mpeg-4	Mpeg1/2 Layer1/2/3, AAC-LC, PCM	Max. solution: 1920x1088 30fps, 80Mbps
	H.264		Max. solution: 7680x4320 30fps (60fps for simple stream), 80Mbps
.VOB	mpeg1/2	Mpeg1/2 Layer1/2/3	Max. solution: 1920x1088 30fps, 80Mbps
.mpg.mpeg	mpeg1/2	Mpeg1/2 Layer1/2/3, AAC-LC, PCM	Max. solution: 1920x1088 30fps, 80Mbps
.webm	vp9	Mpeg1/2 Layer1/2/3, AAC-LC, PCM, opus	Max. solution: 7680x4320 60fps, 80Mbps
	vp8		Max. solution: 1920x1088 30fps, 38.4Mbps
.ts	H.265	Mpeg1/2 Layer1/2/3, AAC-LC, PCM, opus	Max. solution: 7680x4320 60fps, 100Mbps
	mpeg1/2		Max. solution: 1920x1088 30fps, 80Mbps
	H.264		Max. solution: 7680x4320 30fps (60fps for simple stream), 80Mbps

USING THE APPS

Audio

File	Format	Audio codec	Supported range
.aac	AAC, M4A	ADIF, ATDS Header AAC-LC, AAC-ELD	Sample rate: 8KHz~48KHz Bit rate: N/A
.mpeg	MP1, MP2, MP3	MPEG1/2/2.5 Audio Layer1/2/3	Sample rate: 8KHz~48KHz Bit rate: 8Kbps~320Kbps, CBR and VBR
.flac	FLAC	Compress Level 0~8	Sample rate: 8KHz~48KHz Bit rate: N/A
.ape	Monkey's Audio	/	/
.opus	OPUS	OPUS	Sample rate: 8KHz~48KHz Bit rate: 32Kbps~9612Kbps
.mp3	MPEG Audio Layer 3	MPEG1/2 Layer3	Sample rate: 8KHz~48KHz Bit rate: 8Kbps~320Kbps
.ogg	OGG, OGA, Vorbis	Q1~Q10	Sample rate: 8KHz~48KHz Bit rate: N/A
.mid	XMF, MXMF, RTTTL, RTX, OTA, IMY	Midi Type 0 and 1, DLS version 1 and 2, XMF and Mobile XMF, RTTTL/RTX, OTA, iMelody	Sample rate: N/A Bit rate: N/A
.wav	WAV	MS-ADPCM, IMA-ADPCM, PCM	Sample rate: 8KHz~48KHz Bit rate: N/A

Photo

File	Format	Supported range	Remarks
.jpeg/jpg	JPEG	48x48 pixels to 65536x65536 pixels	(1) Not support non-interleaved Scan (2) Software support SRGB JPEG (3) Software support Adobe RGB JPEG
.png	PNG	/	/
.bmp	BMP	/	/
.gif	GIF	/	/

USING THE APPS

Playing videos

Select the video you want play and tap twice on it to start playback.



During the playback tap on the screen to open the playback control toolbar. Then tap any of the following:

Item	Description
	List Display video thumbnails.
	Rewind Rewind video.
	Previous video Skip to the previous video.
	Pause/Play toggle Tap to Pause the playback. To resume, tap .
	Next video Skip to the next video.
	Fast forward Fast forward video.
	Loop/Play once toggle Tap to play all video files in a loop or tap to play the current video file in a loop. Tap to play through all videos in the list once.
	Volume control Adjust the volume level.

Note: To stop playback, open the side toolbar and tap or press the **Back** button on the remote control. When the confirmation message appears, select **Confirm**.

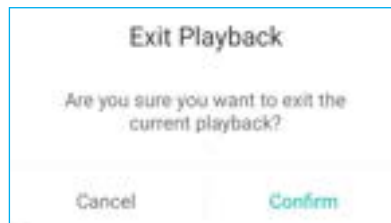







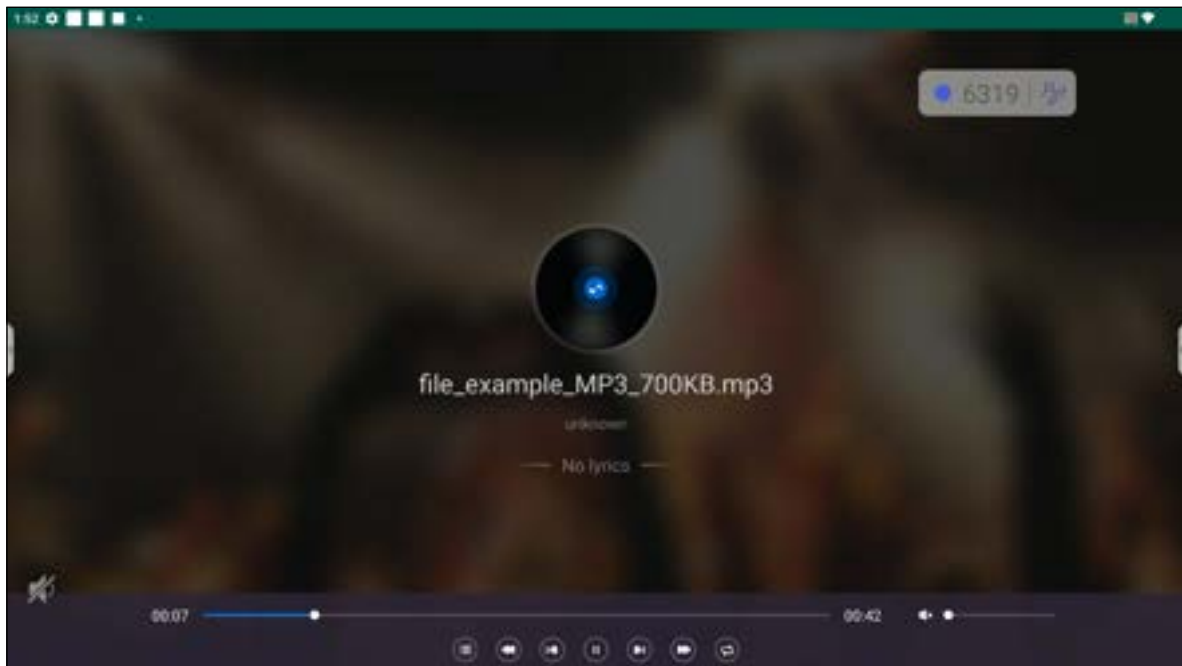





USING THE APPS

Playing music

Select the audio track you want to play and tap twice on it to start playback.



During playback tap on the screen to open the playback control toolbar. The table below explains the functions available on the playback control toolbar.

Item		Description
	List	Display track list.
	Rewind	Rewind the track.
	Previous track	Return to the previous track.
	Pause/Play toggle	Tap  to Pause playback. To resume, tap  .
	Next track	Skip to the next track.
	Fast forward	Fast forward the track.
	Loop/Play once toggle	Tap  to play all tracks in a loop or tap  to play the current track in a loop. Tap  to play through all tracks in the list once.
	Volume control	Adjust the volume level.

Note: To stop playback, open the side toolbar and tap  or press the **Back** button on the remote control. When the confirmation message appears, select **Confirm**.

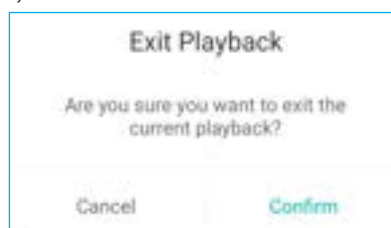





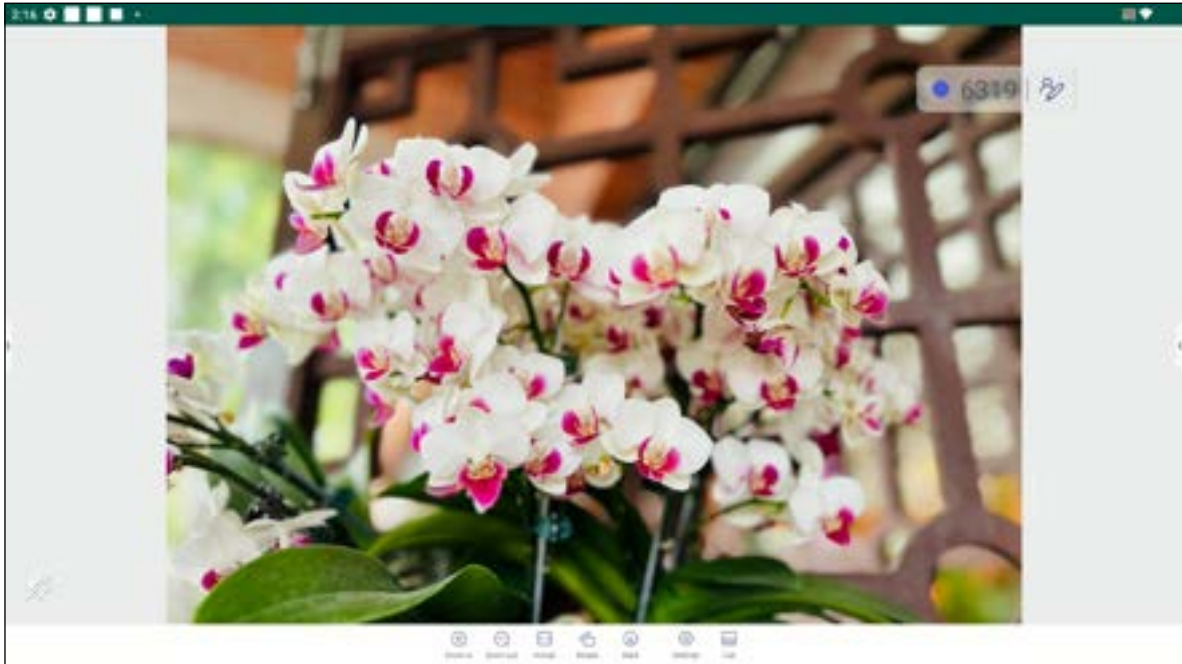

USING THE APPS

Viewing images

Select the image you want to display and tap twice to open it on the screen.



Tap on the screen to open the image control toolbar. The table below explains the functions available on the image control toolbar.

Item		Description
	Zoom in/Zoom out	Magnify the image or zoom out on the magnified image. <ul style="list-style-type: none"> As an alternative, touch the screen with your two fingers and move them apart to zoom in or together to zoom out.
	Actual	Display the image in its actual size.
	Rotate	Rotate the image clockwise.
	Mark	Annotate over the image.
	Settings	<ul style="list-style-type: none"> Configure the slideshow settings and tap Play into full-screen to start the slideshow. Tap  to stop the slideshow. Tap Set to Wallpaper to set the image as the device wallpaper.
	List	Display image list.

Note: To return to the file manager, open the side toolbar and tap  or press the **Back** button on the remote control.

USING THE APPS

Browser



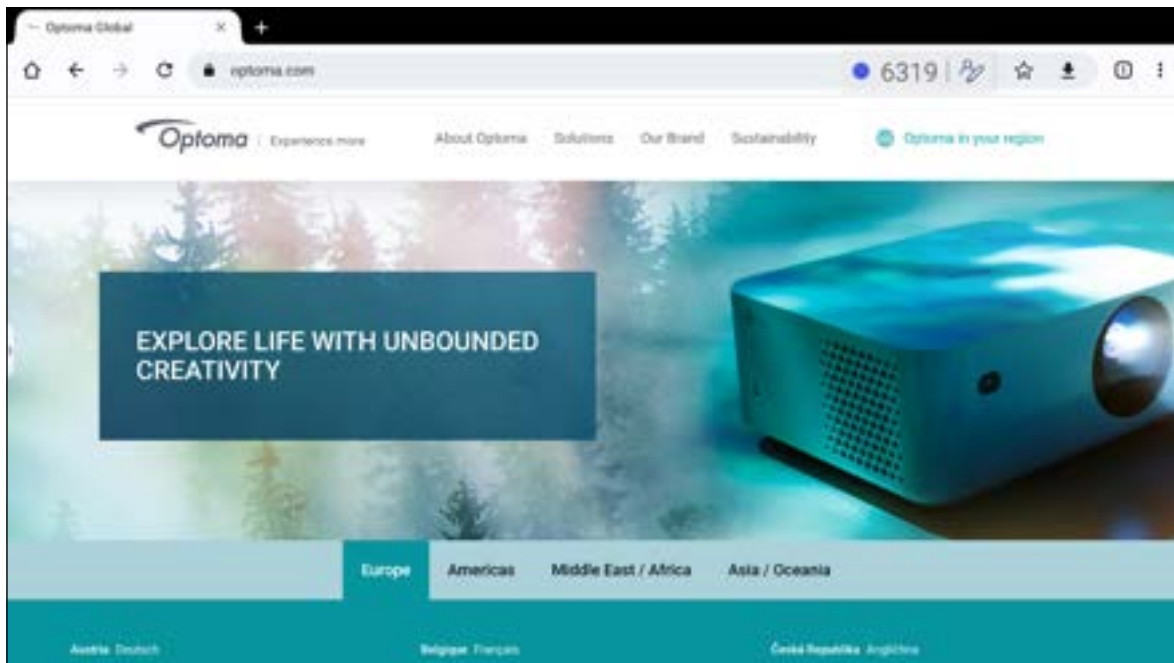

Tap **Browser** to access web pages.



USING THE APPS

Keeper

Tap **Keeper** to open the **Keeper** app and begin cleaning and optimizing the data on the IFP.

- For automatic cleaning of the memory, deleting temporary and junk files, tap **One Key Optimize**.
- For manual cleaning of the memory, tap **Clean Memory** . For manual deleting temporary and junk files, tap **Clean Trash** .
- Tap **Info**  to view system and touch panel versions.
- Tap **EXIT**  to close **Keeper**.

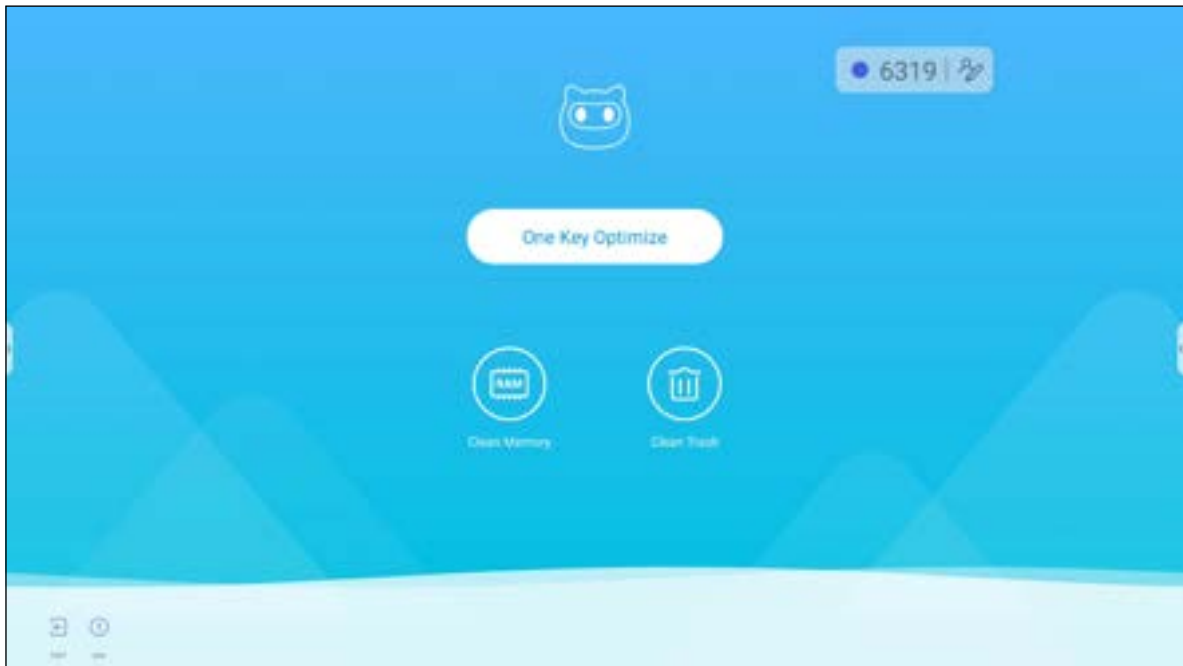

USING THE APPS

Optoma Management Suite (OMS)™

OMS is a remote management software that operates through LAN or over Internet. It simplifies the management of the IFP remotely.

Note: For more detail function introduction, please refer to <https://onlinemanual.optoma.com/OMS/>.

To start using OMS, complete the following steps:

1. Log in to OMS website: <https://oms.optoma.com/>.
2. In the Settings ⇒ Device menu, tap **Optoma Management Suite**.

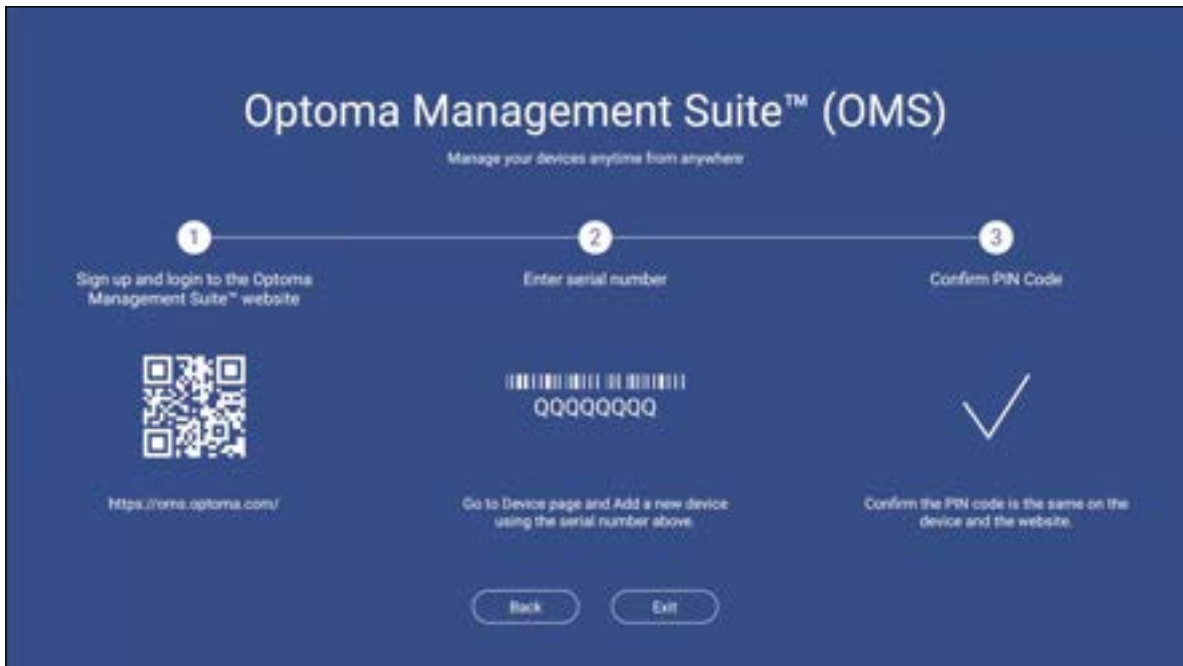

3. In the OMS, click on the **Device** category .
4. Enter the serial number from the **Optoma Management Suite** launcher page and click **Next**.

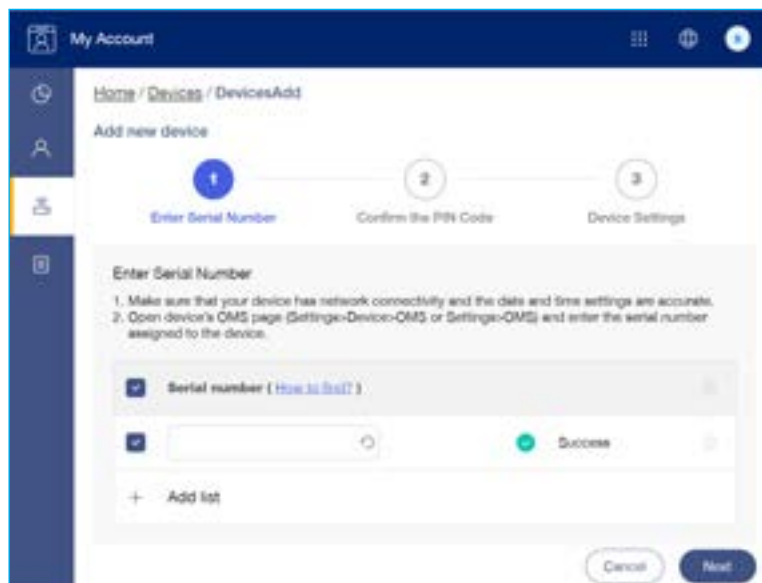

USING THE APPS

5. Confirm the pin codes on the IFP and your device. Click **Next**.

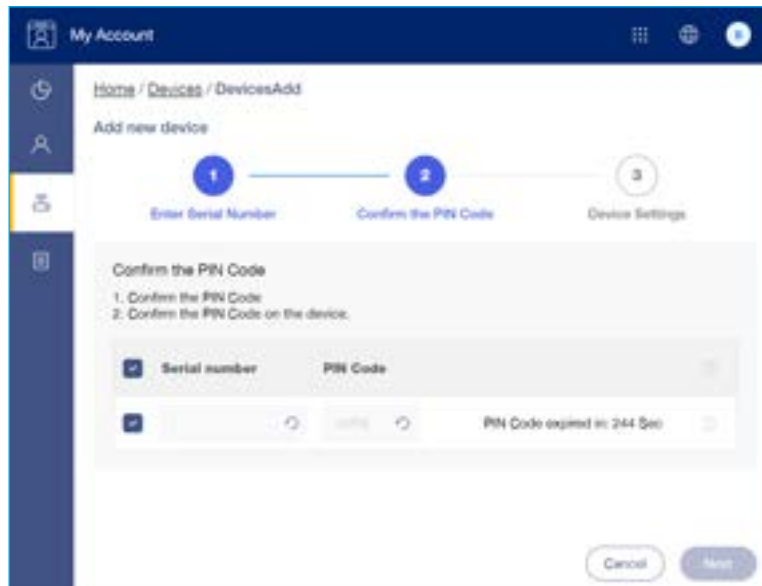

6. Enter the device name and click **Done**.

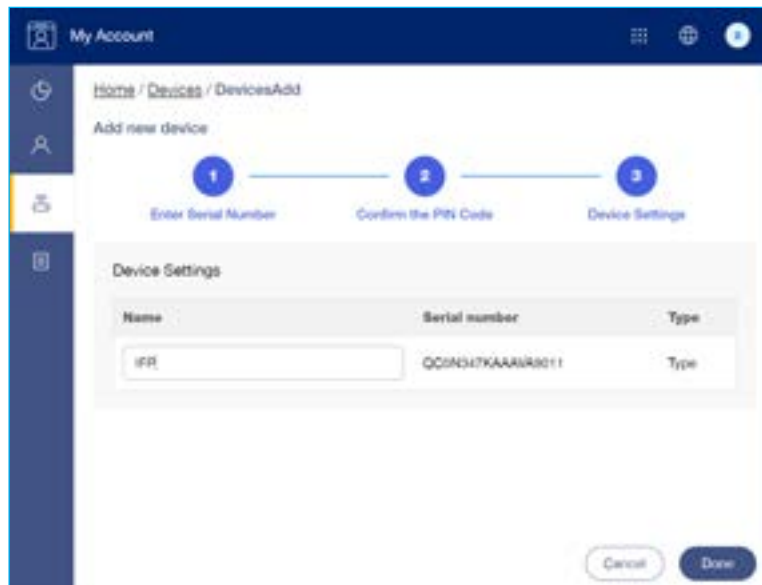

7. Select the device and then use the screen controls to display a message on the screen of the selected IFP, power on/off the IFP, enable/disable wake on LAN, select an input source, enable/disable AV mute mode, mute or unmute the IFP, monitor the device's status, usage time, mute status, temperature, and more.



Note: For enhanced device management, you can group similar devices. To create a device group, click **Add** ⇒ **Group**. Then add the selected devices to the group.

ADDITIONAL INFORMATION

Dimensions

65-inch

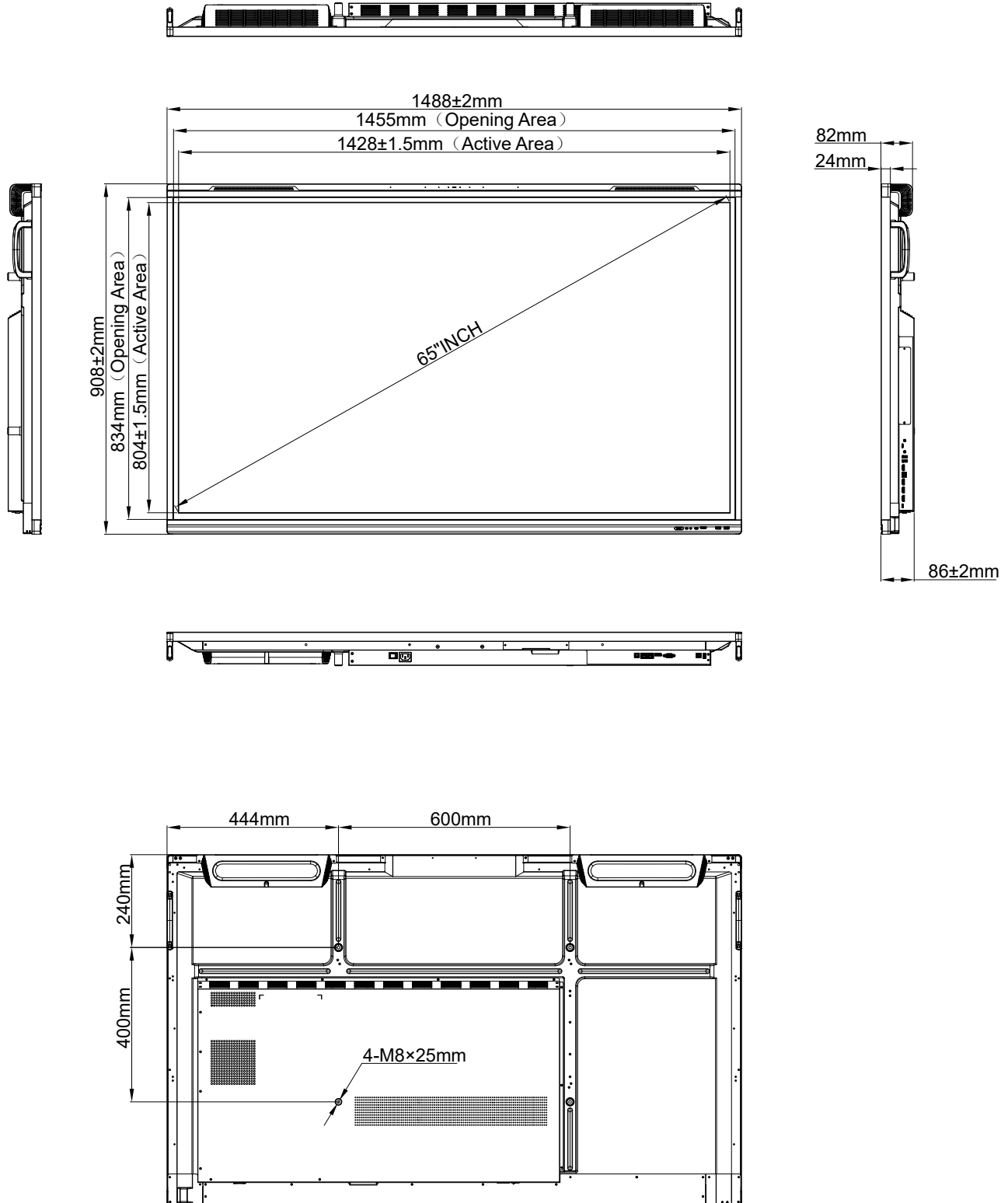

Unit: mm

ADDITIONAL INFORMATION

75-inch

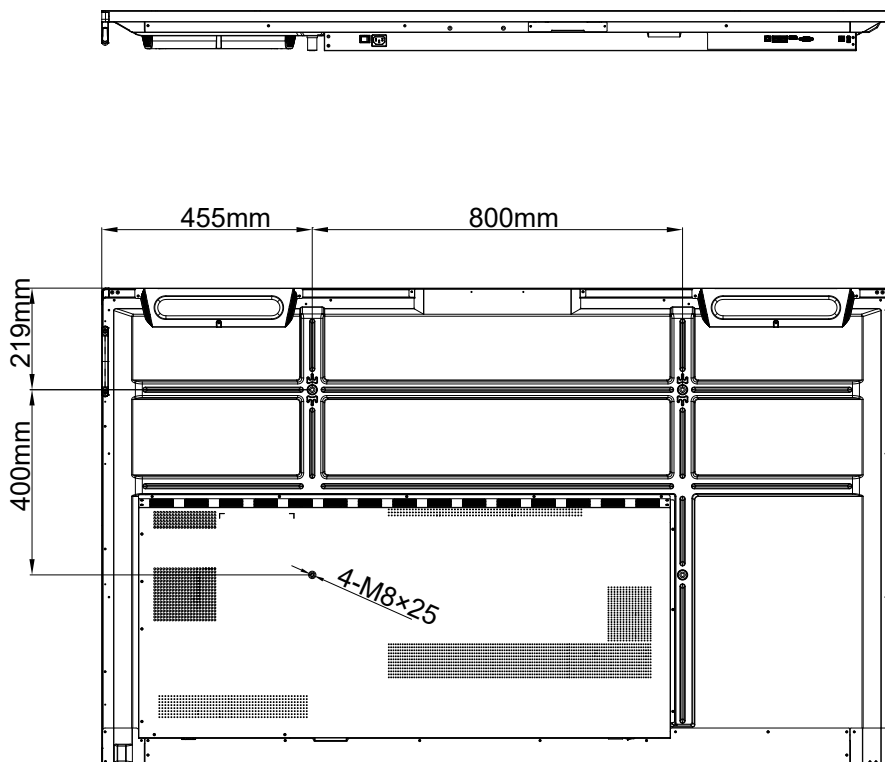
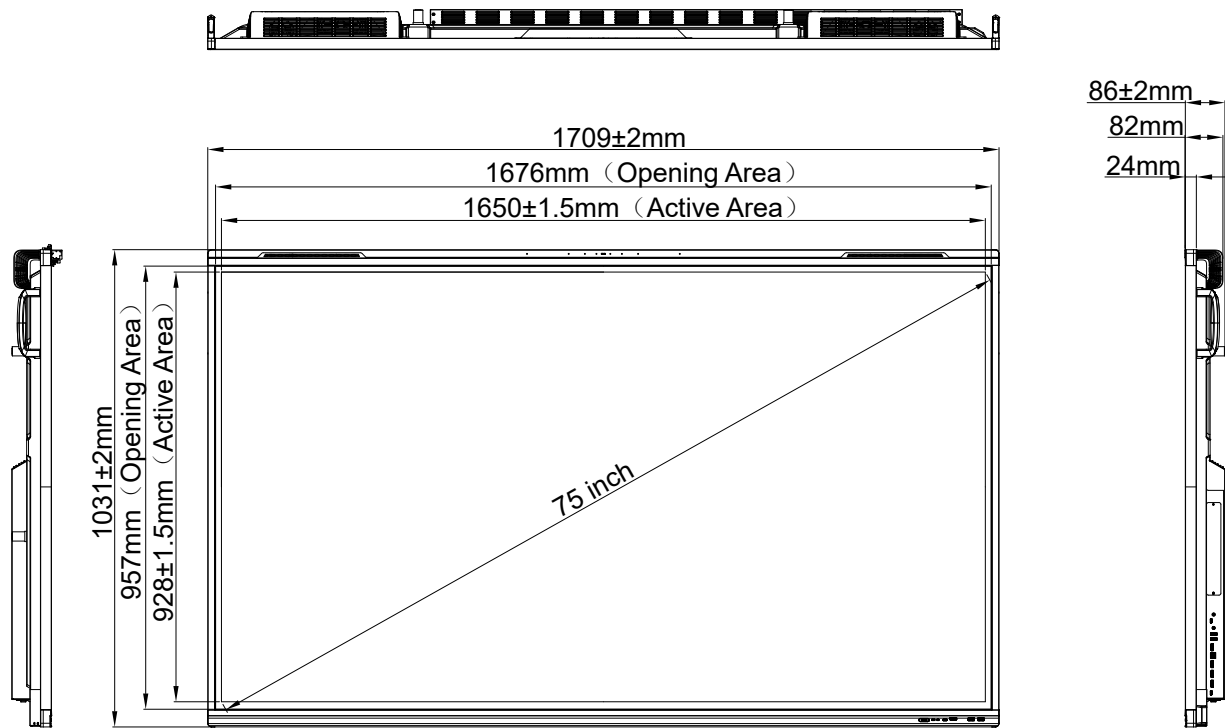

Unit: mm

ADDITIONAL INFORMATION

86-inch

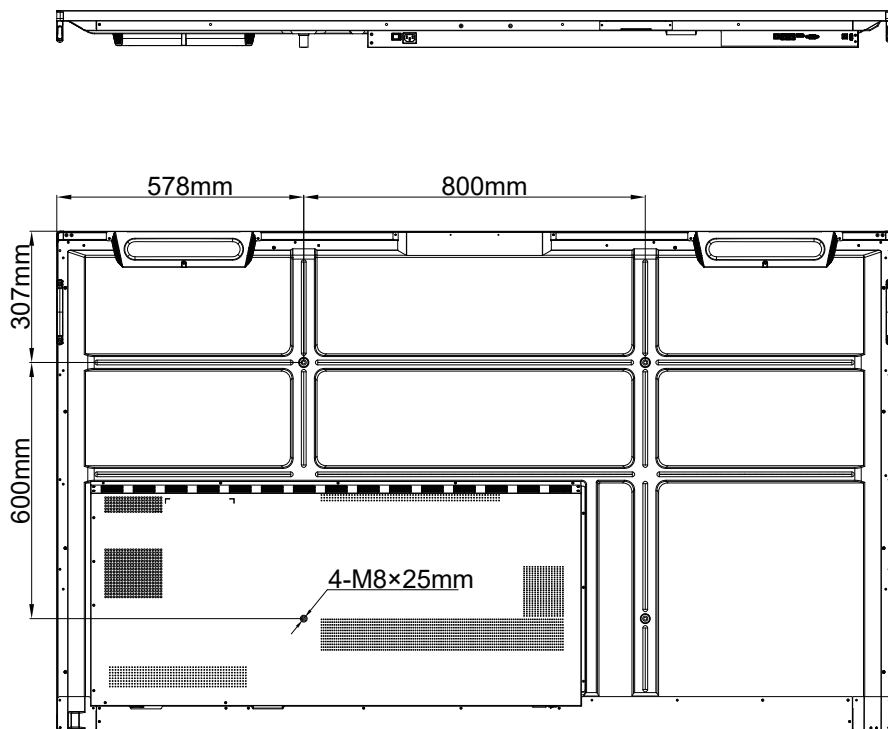
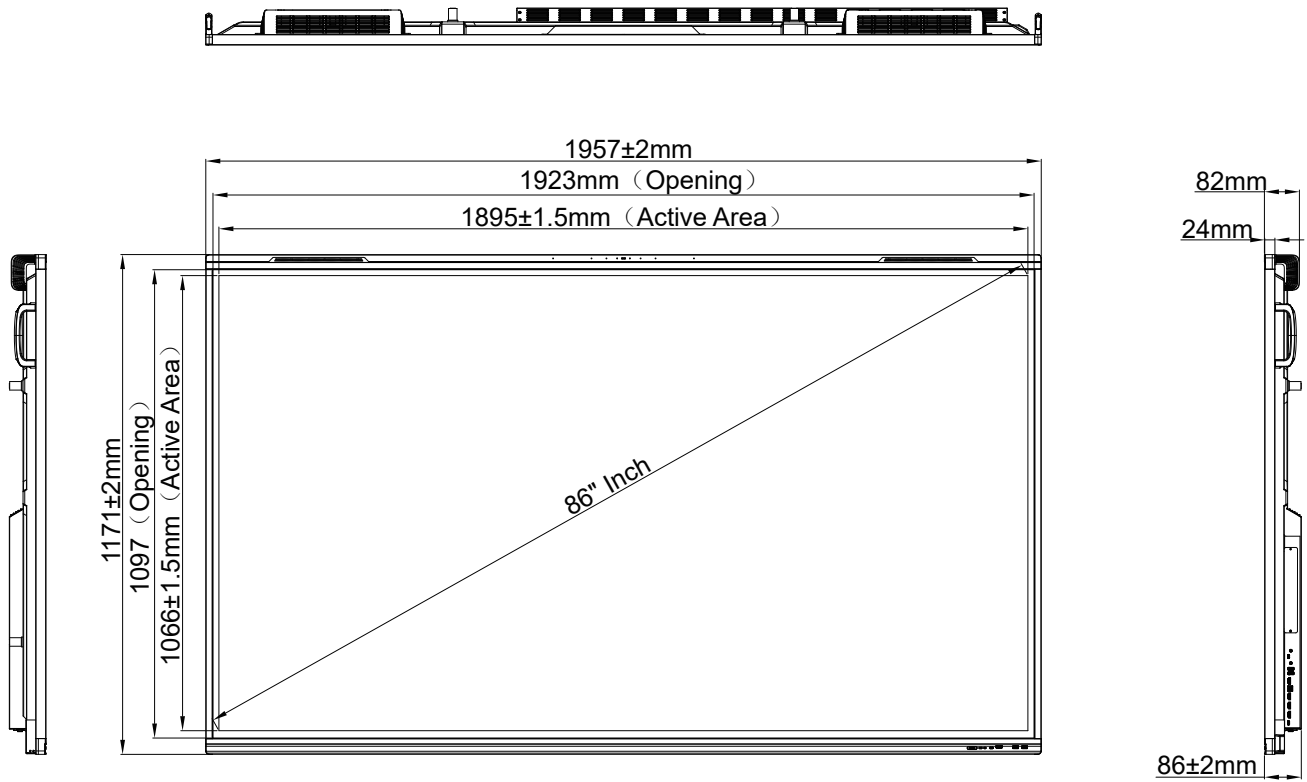

Unit: mm

ADDITIONAL INFORMATION

Supported Timing List

No.	Signal Timing Name	Reference	Clock	Hf	Vf	Input Source		
			[MHz]	[KHz]	[Hz]	VGA	HDMI1/2/3 (2.0)	Type C
1	720x400 @70Hz	IBM	28.32	31.78	70.00	Y	/	Y
2	640x480 @60Hz	VESA	25.18	37.92	59.94	Y	Y	Y
3	640x480 @72Hz	VESA	31.50	37.86	72.81	Y	/	Y
4	640x480 @75Hz	VESA	31.50	37.50	75.00	Y	/	Y
5	800x600 @56Hz	VESA	36.00	35.15	56.25	Y	/	Y
6	800x600 @60Hz	VESA	40.00	37.87	60.31	Y	Y	Y
7	800x600 @72Hz	VESA	50.00	48.07	72.18	Y	/	Y
8	800x600 @75Hz	VESA	49.50	46.87	75.00	Y	/	Y
9	832x624 @75Hz	MAC	57.28	49.72	74.55	Y	/	Y
10	1024x768 @60Hz	VESA	65.00	48.36	60.00	Y	Y	Y
11	1024x768 @70Hz	VESA	75.00	56.47	70.06	Y	/	Y
12	1024x768 @75Hz	VESA	78.75	60.02	75.02	Y	/	Y
13	1152x864 @75Hz	VESA	108.00	67.50	75.00	Y	/	Y
14	1280x768 @60Hz(RB)	CVTRB	68.25	47.39	59.99	Y	Y	Y
15	1280x768 @60Hz	CVT	79.50	47.77	59.87	Y	Y	Y
16	1280x720 @60Hz	CEA-861	74.25	44.67	60.00	Y	/	Y
17	1280x800 @60Hz	CVT	83.50	49.70	59.81	Y	Y	Y
18	1280x960 @60.000Hz	VESA	108.00	60.00	60.00	Y	Y	Y
19	1280x1024 @60Hz	VESA	108.00	63.98	60.00	Y	Y	Y
20	1360x768 @60Hz	VESA	85.50	47.71	60.01	Y	Y	Y
21	1440x900 @60Hz(RB)	CVTRB	88.75	55.46	59.90	Y	Y	Y
22	1440x900 @60Hz	CVT	106.50	55.93	59.88	Y	Y	Y
23	1600x1200 @60Hz	VESA	162.00	75.00	60.00	Y	/	Y
24	1680x1050 60Hz	CVT	146.25	65.29	59.95	Y	Y	Y
25	1920x1080 60Hz	CEA-861	148.50	67.50	60.00	Y	Y	Y
26	720(1440)x480i	CEA-861	27.00	15.73	59.94	/	Y	/
27	480p 59Hz	CEA-861	27.00	31.46	59.94	/	Y	/
28	480p 60Hz	CEA-861	27.02	31.50	60.00	/	Y	/
29	720(1440)x576i	CEA-861	27.00	15.62	50.00	/	Y	/
30	576p	CEA-861	27.00	31.25	50.00	/	Y	/
31	720p 60Hz	CEA-861	74.25	45.00	60.00	/	Y	/
32	720p 59Hz	CEA-861	74.17	44.95	59.94	/	Y	/
33	720p 50Hz	CEA-861	74.25	37.50	50.00	/	Y	/
34	1080i 60Hz	CEA-861	74.25	33.75	60.00	/	Y	/

ADDITIONAL INFORMATION

No.	Signal Timing Name	Reference	Clock	Hf	Vf	Input Source		
			[MHz]	[KHz]	[Hz]	VGA	HDMI1/2/3 (2.0)	Type C
35	1080i 59Hz	CEA-861	74.17	33.71	59.94	/	Y	/
36	1080i 50Hz	CEA-861	74.25	28.12	50.00	/	Y	/
37	1080p 60Hz	CEA-861	148.25	67.50	60.00	/	Y	/
38	1080p 59Hz	CEA-861	148.35	67.44	59.94	/	Y	/
39	1080p 50Hz	CEA-861	148.50	56.25	50.00	/	Y	/
40	1080p 30Hz	CEA-861	74.25	33.75	30.00	/	Y	/
41	1080p 29Hz	CEA-861	74.17	33.71	29.97	/	Y	/
42	1080p 25Hz	CEA-861	74.25	28.12	25.00	/	Y	/
43	1080p 24Hz	CEA-861	74.25	27.00	24.00	/	Y	/
44	1080p 23Hz	CEA-861	74.17	26.97	23.97	/	Y	/
45	3840x2160 60Hz	CEA-861	594.00	135.00	60.00	/	Y	Y
46	3840x2160 50Hz	CEA-861	594.00	112.50	50.00	/	Y	Y
47	3840x2160 30Hz	CEA-861	297.00	67.50	29.97	/	Y	Y
48	3840x2160 25Hz	CEA-861	297.00	56.25	25.00	/	Y	Y
49	3840x2160 24Hz	CEA-861	297.00	54.00	23.98	/	Y	Y
50	4096x2160 24Hz	CEA-861	297.00	54.00	24.00	/	Y	Y

ADDITIONAL INFORMATION

RS232 Protocol Function List

Note: IFP supports RS232 and RJ45 (port 23) control command.

RS232 Pin Assignments

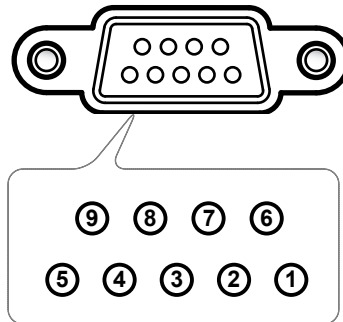

Pin No.	Spec. (from IFP side)
1	N/A
2	TXD
3	RXD
4	N/A
5	GND
6	N/A
7	N/A
8	N/A

RS232 RJ45 Control Connection

RS232 Settings	
Baud Rate	9600
Data Bits	8
Parity	None
Stop Bits	1
Flow Control	None

LAN Control Settings	
IP	Machine IP
Port	4023

~	X	X	X	X	X	X	X	CR
Lead Code	Device ID (where 01 indicates Device ID = 01)		Command ID		Space	Variable	Carriage return	

ADDITIONAL INFORMATION

SET Command

Type	Category	Parameter	CMD		Hex Code CMD	Response	
						Success	Failed
SET	Power	Power off	~xx00 n	n=0	7E 30 30 30 30 20 30 0d	P	F
		Power on	~xx00 n	n=1	7E 30 30 30 30 20 31 0d	P	F
		Restart	~xx00 n	n=3	7E 30 30 30 30 20 33 0d	P	F
	Power Mode (standby)	Eco.	~xx114 n	n=0	7E 30 30 31 31 34 20 30 0d	P	F
		Active		n=1	7E 30 30 31 31 34 20 31 0d	P	F
	Treble	0 ~ 100	~xx95 n	n=0-100	7E 30 30 39 35 20 30 0d to 7E 30 30 39 35 20 31 30 30 0d	P	F
	Bass	0 ~ 100	~xx96 n	n=0-100	7E 30 30 39 36 20 30 0d to 7E 30 30 39 36 20 31 30 30 0d	P	F
	Balance	0 ~ 100	~xx99 n	n=50-50	7E 30 30 39 39 20 30 0d to 7E 30 30 39 39 20 31 30 30 0d	P	F
	Contrast	0 ~ 100	~xx22 n	n=0-100	7E 30 30 32 32 20 30 0d to 7E 30 30 32 32 20 31 30 30 0d	P	F
	Brightness	0 ~ 100	~xx21 n	n=0-100	7E 30 30 32 31 20 30 0d to 7E 30 30 32 31 20 31 30 30 0d	P	F
	Sound Mode	Standard	~xx252 n	n=1	7E 30 30 32 35 32 20 31 0d	P	F
		Meeting		n=4	7E 30 30 32 35 32 20 34 0d	P	F
		User		n=2	7E 30 30 32 35 32 20 32 0d	P	F
		Classroom		n=3	7E 30 30 32 35 32 20 33 0d	P	F
		Movie		n=5	7E 30 30 32 35 32 20 35 0d	P	F
	Volume	0 ~ 100	~xx81 n	n=0-100	7E 30 30 38 31 20 30 0d to 7E 30 30 38 31 20 31 30 30 0d	P	F
	Video Mute	Off	~xx13 n	n=0	7E 30 30 31 33 20 30 0d	P	F
		On		n=1	7E 30 30 31 33 20 31 0d	P	F
	Mute	Off	~xx80 n	n=0	7E 30 30 38 30 20 30 0d	P	F
		On		n=1	7E 30 30 38 30 20 31 0d	P	F
	Input Source	HDMI1	~xx12 n	n=1	7E 30 30 31 32 20 31 0d	P	F
		HDMI2		n=15	7E 30 30 31 32 20 31 35 0d	P	F
		HDMI3		n=16	7E 30 30 31 32 20 31 36 0d	P	F
		USB Type C1		n=27	7E 30 30 31 32 20 32 37 0d	P	F
		USB Type C2		n=30	7E 30 30 31 32 20 32 37 0d	P	F
		HDMI4		n=29	7E 30 30 31 32 20 32 39 1d	P	F
		DisplayPort		n=20	7E 30 30 31 32 20 32 30 0d	P	F
		Solot in PC		n=25	7E 30 30 31 32 20 32 35 0d	P	F
		Android		n=24	7E 30 30 31 32 20 32 34 0d	P	F
	Aspect Ratio	4:3	~xx60 n	n=1	7E 30 30 36 30 20 31 0d	P	F
16:9		n=2		7E 30 30 36 30 20 32 0d	P	F	
PTP		n=14		7E 30 30 36 30 20 31 34 0d	P	F	
Language	English	~xx70 n	n=1	7E 30 30 37 30 20 31 0d	P	F	
	Français		n=3	7E 30 30 37 30 20 33 0d	P	F	

ADDITIONAL INFORMATION

Type	Category	Parameter	CMD		Hex Code CMD	Response	
						Success	Failed
SET	Language	Español	~xx70 n	n=5	7E 30 30 37 30 20 35 0d	P	F
		Traditional Chinese		n=13	7E 30 30 37 30 20 31 33 0d	P	F
		Simplified Chinese		n=14	7E 30 30 37 30 20 31 34 0d	P	F
		Português		n=6	7E 30 30 37 30 20 36 0d	P	F
		German		n=2	7E 30 30 37 30 20 32 0d	P	F
		Dutch		n=8	7E 30 30 37 30 20 38 0d	P	F
		Polish		n=7	7E 30 30 37 30 20 37 0d	P	F
		Russia		n=17	7E 30 30 37 30 20 31 37 0d	P	F
		Czech		n=19	7E 30 30 37 30 20 31 39 0d	P	F
		Danish		n=24	7E 30 30 37 30 20 32 34 0d	P	F
		Swedish		n=9	7E 30 30 37 30 20 39 0d	P	F
		Italian		n=4	7E 30 30 37 30 20 34 0d	P	F
		Turkish		n=22	7E 30 30 37 30 20 32 32 0d	P	F
		Arabic		n=20	7E 30 30 37 30 20 32 30 0d	P	F
		Romanian		n=27	7E 30 30 37 30 20 32 37 0d	P	F
		Hungarian		n=18	7E 30 30 37 30 20 31 38 0d	P	F
		Finnish		n=11	7E 30 30 37 30 20 31 31 0d	P	F
		Norge		n=10	7E 30 30 37 30 20 31 30 0d	P	F
	Picture Mode	Presentation	~xx20 n	n=1	7E 30 30 32 30 20 31 0d	P	F
		Bright		n=2	7E 30 30 32 30 20 32 0d	P	F
		Cinema		n=3	7E 30 30 32 30 20 33 0d	P	F
		DICOM SIM.		n=13	7E 30 30 32 30 21 33 0d	P	F
		User		n=5	7E 30 30 32 30 20 35 0d	P	F
		HDR		n=21	7E 30 30 32 30 20 32 31 0d	P	F
	Color	0 ~ 100	~xx45 n	n=0-100	7E 30 30 34 35 20 30 0d to 7E 30 30 34 35 20 31 30 30 0d	P	F
	Backlight	0 ~ 100	~xx251 n	n=0-100	7E 30 30 32 35 31 20 30 0d to 7E 30 30 32 35 31 20 31 30 30 0d	P	F
	Color Temp	Cool	~xx36 n	n=2	7E 30 30 33 36 20 32 0d	P	F
		Standard		n=1	7E 30 30 33 36 20 31 0d	P	F
		Warm		n=4	7E 30 30 33 36 20 34 0d	P	F
	Freeze	Unfreeze	~xx04 n	n=0	7E 30 30 30 34 20 30 0d	P	F
		Freeze		n=1	7E 30 30 30 34 20 31 0d	P	F
	Pixel shift interval (min)	Off	~xx250 n	n=0	7E 30 30 32 35 30 20 30 0d	P	F
2		n=2		7E 30 30 32 35 30 20 32 0d	P	F	
3		n=3		7E 30 30 32 35 30 20 33 0d	P	F	
5		n=5		7E 30 30 32 35 30 20 35 0d	P	F	
30		n=30		7E 30 30 32 35 30 20 33 30 0d	P	F	
60		n=60		7E 30 30 32 35 30 20 36 30 0d	P	F	
Remote control command	Vol +	~xx140 n	n=17	7E 30 30 31 34 30 20 31 37 0d	P	F	

ADDITIONAL INFORMATION

Type	Category	Parameter	CMD		Hex Code CMD	Response	
						Success	Failed
SET	Remote control command	Vol -	~xx140 n	n=18	7E 30 30 31 34 30 20 31 38 0d	P	F
		Remote UP		n=10	7E 30 30 31 34 30 20 31 30 0d	P	F
		Remote DOWN		n=14	7E 30 30 31 34 30 20 31 34 0d	P	F
		Remote LEFT		n=11	7E 30 30 31 34 30 20 31 31 0d	P	F
		Remote RIGHT		n=13	7E 30 30 31 34 30 20 31 33 0d	P	F
		Remote OK		n=12	7E 30 30 31 34 30 20 31 32 0d	P	F
		Remote Menu Key		n=20	7E 30 30 31 34 30 20 32 30 0d	P	F
		Remote Input source		n=47	7E 30 30 31 34 30 20 34 37 0d	P	F
		Remote Exit		n=74	7E 30 30 31 34 30 20 37 34 0d	P	F
	Display message on the OSD		~xx210	nn.....n	7E 30 30 32 31 30 20 nn...n od	P	F
	Reset To Default		~xx112	n=1	7E 30 30 31 31 32 20 31 od	P	F
OSD lock	OSD lock On with password	~xx239 1 ~nnnn	~mm =0000(a=7E 303030 30)-9999(a=7E 39393939)	7E 30 30 32 33 39 20 31 20 a 0d	P	F	
	OSD lock Off with password	~xx239 2 ~nnnn	~mm =0000(a=7E 303030 30)-9999(a=7E 39393939)	7E 30 30 32 33 39 20 32 20 a 0d	P	F	

ADDITIONAL INFORMATION

GET Command

Type	Category	CMD		Hex Code CMD	Response		
					Success	Parameter	Failed
GET	Power	~xx124 n	n=1	7E 30 30 31 32 34 20 31 0D	Ok0	Power off	F
					OK1	Power on	F
	Contrast	~xx126 n	n=1	7E 30 30 31 32 36 20 31 0D	OK0-100	0-100	F
	Brightness	~xx125 n	n=1	7E 30 30 31 32 35 20 31 0D	OK0-100	0-100	F
	Volume	~xx120 n	n=1	7E 30 30 31 32 30 20 31 0D	OK0-100	0-100	F
	Video Mute	~xx363 n	n=1	7E 30 30 33 36 33 20 31 0D	OK0	Off	F
					OK1	On	F
	Mute	~xx356 n	n=1	7E 30 30 33 35 36 20 31 0D	OK0	Off	F
					OK1	On	F
	Sound Mode	~xx139	n=1	7E 30 30 31 33 39 20 31 0D	OK1	Standard	F
					OK2	User	F
					OK3	Classroom	F
					OK4	Meeting	F
					OK5	Movie	F
	Input Source	~xx121 n	n=1	7E 30 30 31 32 31 20 31 0D	OK7	HDMI1	F
					OK8	HDMI2	F
					OK9	HDMI3	F
					OK25	HDMI4	F
					OK23	USB Type C 1	F
					OK2	VGA	F
					OK20	Android	F
					OK21	Slot in PC	F
	OK26	USB Type C 2	F				
	Aspect Ratio	~xx127 n	n=1	7E 30 30 31 32 37 20 31 0D	OK1	4:3	F
					OK2	16:9	F
					OK14	PTP	F
	Picture Mode	~xx123 n	n=1	7E 30 30 31 32 33 20 31 0D	OK1	Presentation	F
					OK2	Bright	F
					OK3	Cinema	F
					OK5	User	F
					OK10	DICOM SIM.	F
	Color Temp	~xx128 n	n=1	7E 30 30 31 32 38 20 31 0D	OK21	HDR	F
OK1					Cool	F	
OK0					Standard	F	
WLAN status	~xx451 n	n=1	7E 30 30 34 35 31 20 31 0D	OK3	Warm	F	
				OK0	Disconnected	F	
WLAN Mac address	~xx555 n	n=2	7E 30 30 35 35 35 20 32 0D	OK1	Connected	F	
				Oknn:nn:nn:nn:nn:nn	Mac Address	F	

ADDITIONAL INFORMATION

Type	Category	CMD		Hex Code CMD	Response		
					Success	Parameter	Failed
GET	WLAN IP address	~xx451 n	n=2	7E 30 30 34 35 31 20 32 0D	Oknnn:nnn:nnn:nnn	IP address	F
	LAN status	~xx87 n	n=1	7E 30 30 38 37 20 31 0D	OK0	Disconnected	F
					OK1	Connected	F
	LAN Mac address	~xx555 n	n=1	7E 30 30 35 35 35 20 31 0D	Oknn:nn:nn:nn:nn	Mac Address	F
	LAN IP address	~xx87 n	n=3	7E 30 30 38 37 20 33 0D	Oknnn:nnn:nnn:nnn	IP address	F
	FW version	~xx122 n	n=1	7E 30 30 31 32 32 20 31 0D	Oknnnnnnnnnnnnnnn (ex. 20190926164814)	FW version	F
	Usage hour	~xx108 n	n=1	7E 30 30 31 30 38 20 31 0D	Oknnnnn	Suage hours	F
	Device type	~xx149 n	n=1	7E 30 30 31 34 39 20 31 0D	OK2	Device type = IFP	F
	Information string	~xx150 n	n=1	7E 30 30 31 35 30 20 31 0D	OKabbbbbccdddee (Note*1)		F
			n=2	7E 30 30 31 35 30 20 32 0D	Oknnn	Device native resolution	F
			n=3	7E 30 30 31 35 30 20 33 0D	Oknnn (ex. OKHDMI1)	Input source	F
			n=4	7E 30 30 31 35 30 20 34 0D	Oknnn (ex. OK1920x1080)	Source resolutuion	F
			n=16	7E 30 30 31 35 30 20 31 36 0D	OK0	Power mode (standby) = Eco.	F
					OK1	Power mode (standby) = Active	F
			n=17	7E 30 30 31 35 30 20 31 37 0D	OK0	DHCP = Off	F
					OK1	DHCP = On	F
	n=18	7E 30 30 31 35 30 20 31 38 0D	Oknnn (ex. OK48)	System temperature	F		
	n=19	7E 30 30 31 35 30 20 31 39 0D	Oknnn (ex. OK60Hz)	Source refresh rate	F		
	Regulatory Model name	~xx151 n	n=3	7E 30 30 31 35 31 20 33 0d	Oknnn (ex. SLUGRK)	Regulatory model name (will provide when kick off)	F
System Auto send	Standby Mode			INFO0			
	Warming up			INFO1			
	Cooling down			INFO2			
	Over temperature			INFO7			
GET	OSD lock	~xx229 n	n=1	7E 30 30 32 32 39 20 31 0D	OK0	OSD lock = Off	F
					OK1	OSD lock = On	F
	SN	~XX353 n	n=1	7E 30 30 33 35 33 20 31 0D	Okaaaaaaaa aaaaaaaa	a= serial number string	F

Note: (*1)

Power	Running Time	Input Source	Firmware Version	Display Mode
--------------	---------------------	---------------------	-------------------------	---------------------

ADDITIONAL INFORMATION

<ul style="list-style-type: none"> • <i>a=0 Power Off</i> • <i>a=1 Power On</i> 	<i>Usage hours = nnnnn</i>	<ul style="list-style-type: none"> • <i>cc=02 VGA1</i> • <i>cc=08 HDMI2</i> • <i>cc=10 Component</i> • <i>cc=14 HDMI3</i> • <i>cc=15 DisplayPort</i> • <i>cc=18 Android</i> • <i>cc=19 Slot in PC</i> • <i>cc=21 USB Type C1</i> • <i>cc=24 HDMI4</i> • <i>cc=25 USB type C2</i> 	<i>###</i>	<ul style="list-style-type: none"> • <i>ee=01 Presentation</i> • <i>ee=02 Bright</i> • <i>ee=05 User</i> • <i>ee=21 HDR</i> • <i>ee=03 Cinema</i> • <i>ee=10 DICOM SIM.</i>
---	----------------------------	--	------------	---

LED Indicator

Power LED Color & Behavior	Status
Solid Red	Standby mode
Solid White	Power on
Flash Red then Blue continuously	Backlight off

ADDITIONAL INFORMATION

Troubleshooting

If you experience a problem with your device, please refer to the following information. If a problem persists, please contact your local reseller or service center.



No picture or sound.

- Make sure all signal and power connections are properly connected.
- Make sure the correct input mode is selected. Refer to the “Shortcut Menu” section.
- Make sure the IFP is not turned off.
- Turn off the mute function.
- Make sure the volume is not set to the minimum level.



The IFP automatically shuts down.

- Check whether there is a sudden power outage.
- Make sure the power cord is not disconnected.



The touch panel does not respond to touch

- Make sure the screen is not exposed to direct sunlight or other direct light that may be impeding the IR functionality.
- For the external device connection, make sure the USB cable is properly connected to either the Touch USB port or the USB-C port on the IFP.



If the remote control does not work

- Check that the operating angle of the remote control is pointed within $\pm 30^\circ$ to the IR receiver on the IFP.
- Make sure there are no obstructions between the remote control and the IFP. The distance between the remote control and the IR sensor window should not be longer than 8 meters (~26 feet).
- Make sure batteries are inserted correctly and replace the batteries if they are depleted. Refer to the “Installing/Replacing the Remote Control Batteries” on page 21.

ADDITIONAL INFORMATION

Maintenance

Proper routine maintenance can help with early fault detection and keep the IFP looking like new.

IMPORTANT! *Before cleaning and performing any maintenance task, make sure to unplug the power cord from the power outlet to prevent electric shock.*

Cleaning the Screen

- When the screen requires cleaning, please unplug the power cord first.
- Please use a soft, dust-free, dry cloth to wipe the screen.
- Do not use water or a spray cleaner to clean the IFP.
- Please contact the service center for internal cleaning of the IFP.

Clean the Front Frame

Use a dry, soft, lint-free cloth to wipe the front frame.



ADDITIONAL INFORMATION

Optoma Global Offices

For service or support, please contact your local office.



USA

Optoma Technology, Inc.
47697 Westinghouse Drive.
Fremont, Ca 94539

 888-289-6786
 510-996-4794
 services@optoma.com



Canada

Optoma Technology, Inc.
47697 Westinghouse Drive.
Fremont, Ca 94539

 888-289-6786
 510-996-4794
 services@optoma.com

Latin America

Optoma Technology, Inc.
47697 Westinghouse Drive.
Fremont, Ca 94539

 888-289-6786
 510-996-4794
 services@optoma.com



Europe

1 Bourne End Mills
Hemel Hempstead
Hertfordshire
HP1 2UJ
United Kingdom
www.optoma.eu
Service Tel : +44 (0)1923 691865

 +44 (0) 1923 691 800
 +44 (0) 1923 691 888
 service@tsc-europe.com



Benelux BV

Optoma Benelux BV
Europalaan 770 D
1363BM Almere
The Netherlands
www.optoma.nl

 +31 (0) 36 8200 250
 +31 (0) 36 548 9052



France

Bâtiment E
81-83 avenue Edouard Vaillant
92100 Boulogne Billancourt, France

 +33 1 41 46 12 20
 +33 1 41 46 94 35
 savoptoma@optoma.fr



Spain

C/ José Hierro, 36 Of. 1C 28529 Rivas
Vaciamadrid, Spain

 +34 91 499 06 06
 +34 91 670 08 32



Deutschland

Optoma Deutschland GmbH
Am Nordpark 3
41069 Mönchengladbach
Deutschland

 +49 (0) 2161 68643 0
 +49 (0) 2161 68643 99
 info@optoma.de

Scandinavia

Postboks 9515 Åskollen
Kniveveien 29
Drammen
3036
Norway

 +47 32 98 89 90
 +47 32 98 89 99
 info@optoma.no

Korea

<https://www.optoma.com/kr/>

Japan



<https://jp.optoma.com/>

Taiwan

<https://www.optoma.com/tw/>

China

Room 2001, 20F, Building 4,
No.1398 Kaixuan Road,
Changning District
Shanghai, 200052, China

 +86-21-62947376
 +86-21-62947375
www.optoma.com.cn

Australia

<https://www.optoma.com/au/>

