

RRDJCD400W

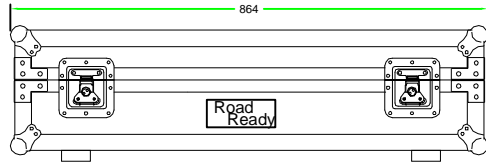

BACK VIEW

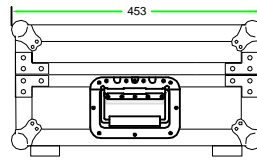

RIGHT VIEW

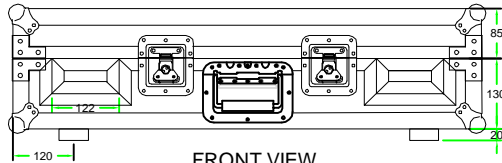

FRONT VIEW

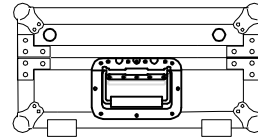

LEFT VIEW

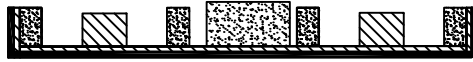

A-A VIEW

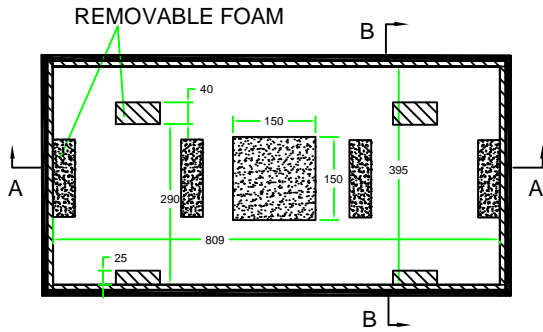

TOP VIEW OF COVER

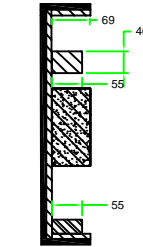

B-B VIEW

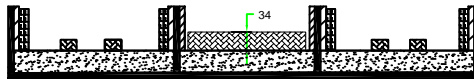

C-C VIEW

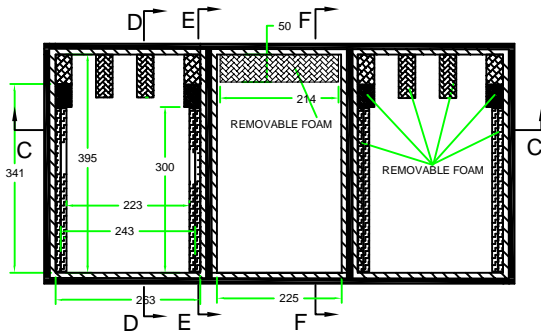

TOP VIEW OF BASE

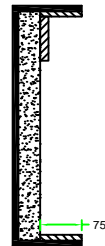

D-D VIEW

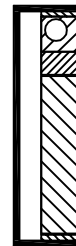

E-E VIEW

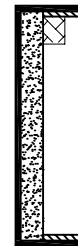

F-F VIEW

Signature of Approval

Printed Name

2009-02-05