



GUIL®

BANDS & ORCHESTRAS BANDAS Y ORQUESTAS 2020



www.guil.es
MADE IN SPAIN

GUIL - YOUR EUROPEAN STAGING MANUFACTURER



P.I. La Creu C/ Ismael Tomás Alacreu, 28-30
C.P.46250 - L'ALCÚDIA (VALENCIA) SPAIN

GUIL - TU FABRICANTE EUROPEO DE ESCENARIOS

Tel. +34 962996500
Fax. +34 962540833

info@guil.es
sales@guil.es



SOPORTES DE TECLADO

KEYBOARD STANDS

Ref. **ST-100**



Ref. **ST-101**



Ref. **ST-120**



Ref. **ST-113**



*1



Ref. **STA-06**



Ref. **STA-05**



Ref. **ST-114**



Ref. **ST-115**



CARROS PARA PIANO

PIANO CARTS

Ref. **CP-01**



Ref. **CP-03**



Ref. **CP-04**



SOPORTES DE PERCUSIÓN

PERCUSSION STANDS



Ref. **XL-01**



Ref. **BM-02**



Ref. **SR-01**



Ref. **PT-01**





Ref. **GT-13**



Ref. **GT-11**



Ref. **GT-12**



Ref. **CT-01**



Ref. **CLL-01**



Ref. **GT-02**



Ref. **GT-06**



Ref. **GT-04**



Ref. **GT-24**



Ref. **RP-01**



Ref. **TR-02**



Ref. **SX-04**



Ref. **FG-02**



Ref. **FG-01**



Ref. **AT-02**



Ref. **AT-12**



Articulación reforzada
Reinforced articulation



Ref. **AT-08**



Ref. **AT-14**



Ref. **LP-01**

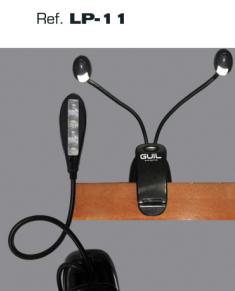

Ref. **LP-11**



Ref. **AT-10**



Ref. **AT-20**



Ref. **AT-13**



Articulación reforzada
Reinforced articulation

TARIMAS DE DIRECTOR CONDUCTOR'S PLATFORMS

- > Estructura de ALUMINIO
- > Incluyen quitamiedos
- > Madera 100% Abedul
- > 1 Pata con nivelador (5 mm)

- > ALUMINIUM Framework
- > Safety Rail included
- > 100% Birch plywood panel
- > 1 Leg with leveller (5 mm)

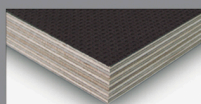

- Ref. **TMD-09** (1 x 1 m)
- Ref. **TMD-10** (1,2 x 1 m)
- Ref. **TMD-11** (1 x 1 m) Con embellecedor de madera. *With wooden skirting.*
- Ref. **TMD-12** (1,2 x 1 m) Con embellecedor de madera. *With wooden skirting.*

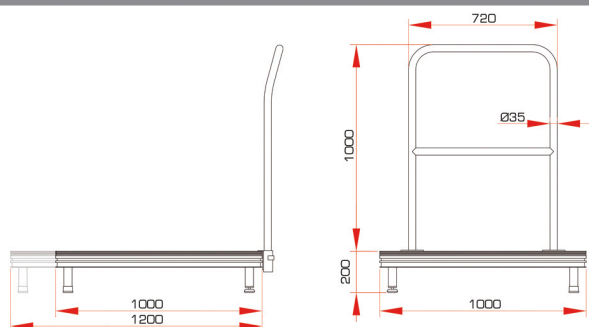

GRADAS PARA CORO

GUIL fabrica módulos rectangulares y trapezoidales para hacer gradas de coro; pudiéndose combinar entre sí para ofrecer a los coristas múltiples opciones y formas (lineales, curvas, en arco, de herradura,...). Nota: Fabricación de medidas especiales bajo petición. Todos nuestros módulos se pueden utilizar en exteriores e interiores, y la altura puede ser fija o regulable para una mayor flexibilidad. Están fabricados en aluminio, con panel contrachapado fenólico con acabado antideslizante (tablero de madera 100% abedul).

Soluciones prácticas, resistentes y seguras, de rápido y sencillo montaje.

CHORAL RISERS

GUIL manufactures choral riser elements with different designs to offer choirs multiple riser options and shapes (straight, curved, winged, horseshoe arrangement, etc.). We make different shapes & sizes on request. All our choral risers can be used outdoors and can be height adjustable for great design flexibility. They are manufactured in aluminium, making them sturdy but lightweight, and we use a non-slip, water resistant, 100% birch phenolic plywood panels which not only means they can be used for outdoor events but these features make them extremely durable.

Practical, durable and safe solutions, with a quick and easy set-up.

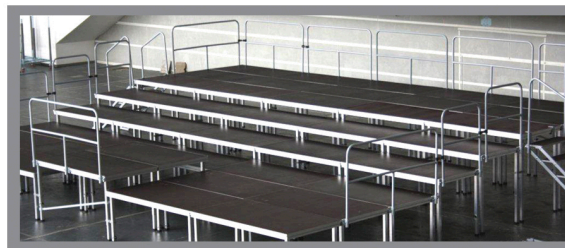

GUIL

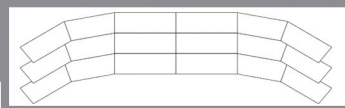

Ref. **GR** Módulos RECTÁNGULARES para hacer gradas de coro.
Medidas estándar: 2 x 0,5 m y 1,5 x 0,5 m
RECTANGULAR shaped module to make choral risers.
Standard dimensions: 2 x 0.5 m and 1.5 x 0.5 m

Ref. **GRT-1** Módulo TRAPEZOIDAL para hacer gradas de coro
TRAPEZIUM shaped module to make choral risers

- > Estructura de ALUMINIO
- > Madera 100% Abedul
- > Superficie antideslizante
- > Alturas fijas y regulables
- > Rápido y sencillo montaje
- > Fabricación a medida
- > Uso en interiores y exteriores

- > ALUMINIUM Framework
- > 100% Birch plywood panel
- > Non-slip surface
- > Adjustable & fixed heights
- > Fast & easy assembly
- > Custom sizes on request
- > INDOOR & OUTDOOR USE

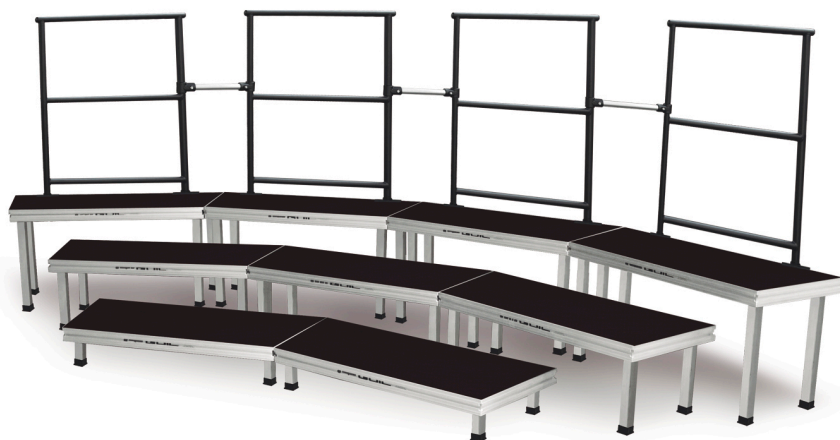
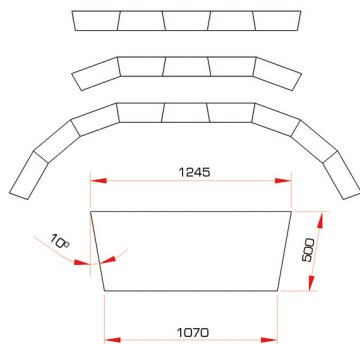



Ref. **SL-02**



Ref. **SL-11**



Ref. **SL-12**



Ref. **SL-14**



Ref. **SL-15**



Ref. **BQ-01**



Ref. **BQ-02**



Ref. **BQ-04**



Ref. **BQ-05**



Ref. **BQ-05 +**
Ref. **SL-R/1**



Ref. **SL-07**
*1



Ref. **SL-08**
*1



Ref. **SL-25**



Ref. **SL-25 +**
Ref. **SL-R/1**





Ref. **SLL-03**
*2 *3



100% ESTABILIDAD
100% STABILITY



Ref. **SLL-02**
*2 *3



Ref. **SLL-01**
*2 *3



Ref. **SL-20**
*2



Ref. **SL-51**
*4 *5



Ref. **SL-50**
*4 *6



Ref. **SL-40**
*4 *5



Ref. **SL-60**
*4 *6



Ref. **SL-61**
*6

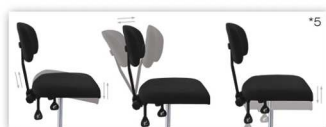

PIES DE MICRO MICROPHONE STANDS

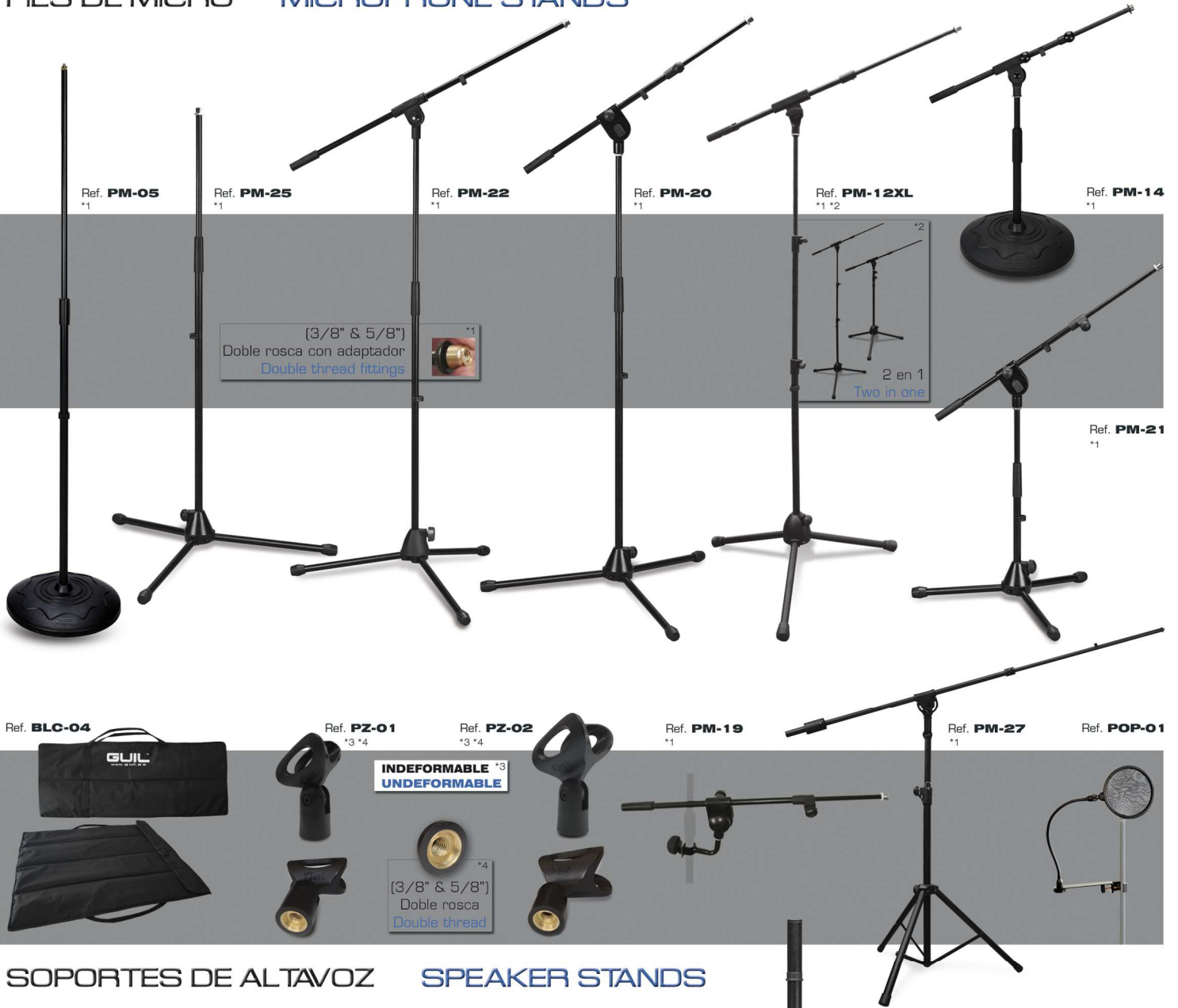

SOPORTES DE ALTAVOZ SPEAKER STANDS

