

DECO22

DECO series aluminium square trusses

ISO DIN 4113 and TÜV certified.

Made of 35mm aluminium alloy (AL 6060-T diameter 35 mm, thickness 1.6 mm).

This is the series you need for your shop, exhibition stand or decorations.

This structure is supplied with :

- 1 x connection kit per bar
- 1 x 2-direction angle connection kit
- 2 x 3-4 direction angle connection kit

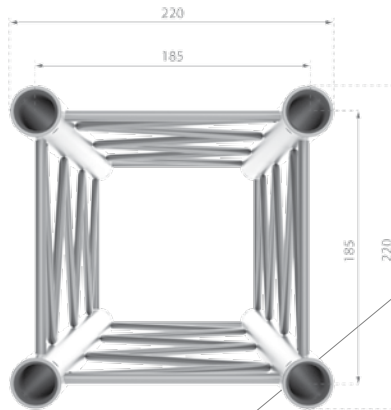

160

DECO220-PT50

ref 10218

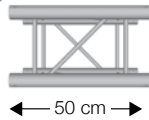

DECO220-PT100

ref 10219

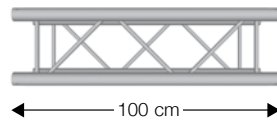

DECO220-PT200

ref 10220

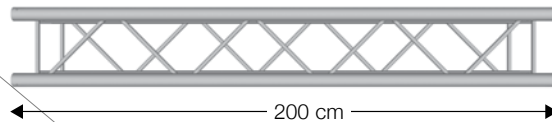





LENGTH (M)		1	2	3	4	5	6
Max load (center) (kg)		257,67	198,02	160,79	135,35	116,86	102,81
Distortion (mm)		0,1	0,8	2,2	4,4	7,4	11,3
Max distributed load (kg/m)		420	208	137,33	99,24	65,20	45,94
Distortion (mm)		0,1	1,1	3,5	8,1	13	19

Table loads indicate the maximum load-bearing capacity between two fixation points. Centered and distributed loads cannot be cumulated. Talk to a qualified engineer for more information.



ANGLE CONNECTION KITS

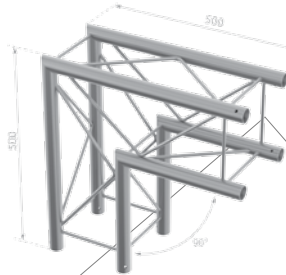
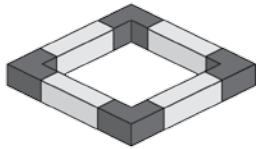

+ 220 mm angle
+ 2x90° directions

DECO22Q-AG01

ref 10221

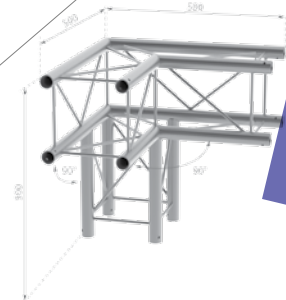
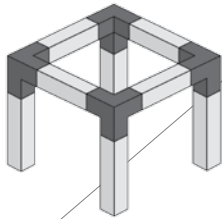

+ 220 mm angle
+ 3 directions
+ 3x90° side-oriented directions

DECO22Q-AG02

ref 10222

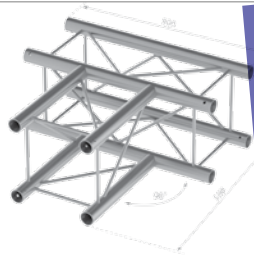
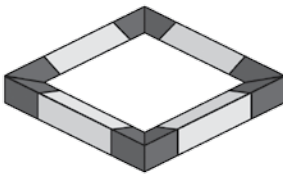

+ 220 mm angle
+ 3 directions
+ 3x90° horizontal directions

DECO22Q-AG03

ref 10223

DECO22 ACCESSORIES

1. DECO22Q-MCKIT

4 connectors, 8 safety pins and 8 pins kit
ref 10224

1.



2. DECO22Q-EM-B1

Baseplate with fasteners for DECOqua series
ref 10225

2.



3. DECO22-CLAV

Pin for DECO series conical connectors
ref 10227

3.



4. DECO22-MANCH

Conical connector for Déco series structures
ref 10226

4.



5. DECO22-GOUP

Safety pin for Déco series
ref 10228

5.



6. DECO22-1/2MANCH

M8 conical half-connector for 35mm tube
ref 10332

6.



NEW