



VEXO115A

15" high performance 2-way active loudspeaker

Highlights:

- Compatible with AUDAC Touch™
- Dante™ expansion port
- Advanced DSP and loudspeaker management
- DuraCoat™ texture paintwork
- High sound pressure levels with tight driver response
- Compatible with TouchLink™
- Ball impact resistance
- Horizontal and vertical mounting
- User friendly mounting
- -90° to +35° inclination
- WaveDynamics™ supported

The VEXO series are compact high performance 2-way active loudspeakers and come in 3 different models, each of them with different sizes and performances meeting the requirements of every application. The low-frequency transducer, which is made out of high-quality materials, is combined with a 1.7" voice coil compression driver, enabling high sound pressure levels and a tight driver response with a rotatable 90° x 70° coverage pattern for a wide range of applications.

Thanks to the unique driver composition, the VEXO115A delivers a clear and natural sound with an RMS power of 500 Watts and a maximum power of 2000 Watt. The frequency response ($\pm 3\text{dB}$) starts from 50Hz up to 20 kHz and the sensitivity (1W/1m) reaches 100dB while a maximum continuous sound pressure level from 127dB can be achieved.

The construction of the cabinets is made of 12mm plywood with a polyurethane coating, making them resistant to any impact. The front side of the cabinet is finished with a powder-coated steel grill with acoustical foam. A recessed carry handle on the rear side makes carrying easy. Positioning and suspension of the speaker are easily achieved by using the standard 35 mm pole adapter on the bottom and the M10 rigging points. Two speaker connectors provide reliable connections with easy link-through to cabinets.

The optional Clever U bracket allows mounting the high power 2-way cabinet both horizontally and vertically. An inclination of -90° to +35° ensures an optimal positioning.

The optional MBK bracket even allows mounting the VEXO series to the ceiling which gives the opportunity to install the loudspeaker cleanly in any environment. By installing the optional ANI44XT Dante™ audio network interface in the active loudspeaker, the VEXO series can be integrated into any Dante enabled AV network and transfer digital audio with any compatible solution on the market.

The VEXO115A features the unique WaveDynamics™ innovation. Due to this DSP processor, the audio control and processing technology enable any user to effortless control the most advanced acoustic configurations.

The integrated DSP allows pre-sets for full-range, satellite and custom configurations and can be loaded via the USB slot on

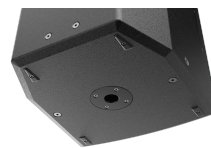

Certification:



the back of the device. The AUDAC Touch™ application allows to equalize and create personalised presets and control the equipped VEXO loudspeakers. When installing the ANI44XT, all personalised presets and settings can be adjusted from anywhere at any time.

Impedance:



Applications:

- Education
- Sport facilities
- Clubs
- Concert venues

System specifications:

Speaker type			2-way
Max. Power			2000 W
RMS Power			500 W
Impedance			8 Ω
Sensitivity (1W/1m)			100 dB
Sound Pressure (Max. W/1m)			127 dB
Frequency	Response (± 3 dB)	50 Hz - 20 kHz	
Crossover	Type	Active	
Dispersion	Horizontal	90°	
	Vertical	70°	
Drivers	HF	Compression driver with 1.7" VC and 1" throat	
	LF	15" (3" VC)	
Connectors	Remote control	RJ45	
	Input	2 x Combo XLR / 6.3 mm jack	
		3-pin Euro Terminal Block (Pitch - 3.81 mm)	
		3-Pin terminal block (linkthrough)	
Inputs		XLR male (linkthrough)	
		USB port	
		RJ45 (Ethernet)	
Power	Consumption	Standby	3.2 W
		Idle	22.5 W

Product Features:

Dimensions		429 x 690 x 450 mm (W x H x D)
Weight		28.3 kg
Construction		12 mm high-quality plywood
Finish	Cabinet finishing	Polyurethane coating
Front finish		Powder coated steel grill with acoustical foam
Mounting & handling	Rigging points	10 x M10
	Stand fitting	35 mm pole adapter on bottom
	Carry handles	On top
Powerdrive mount		Powerdrive type 100 (127 x 70 mm)
Colours		Black & White
Accessories	Optional	ANI44XT - Dante™ audio network interface

PRELIMINARY

Acoustical data graphs:

Horizontal Polars:

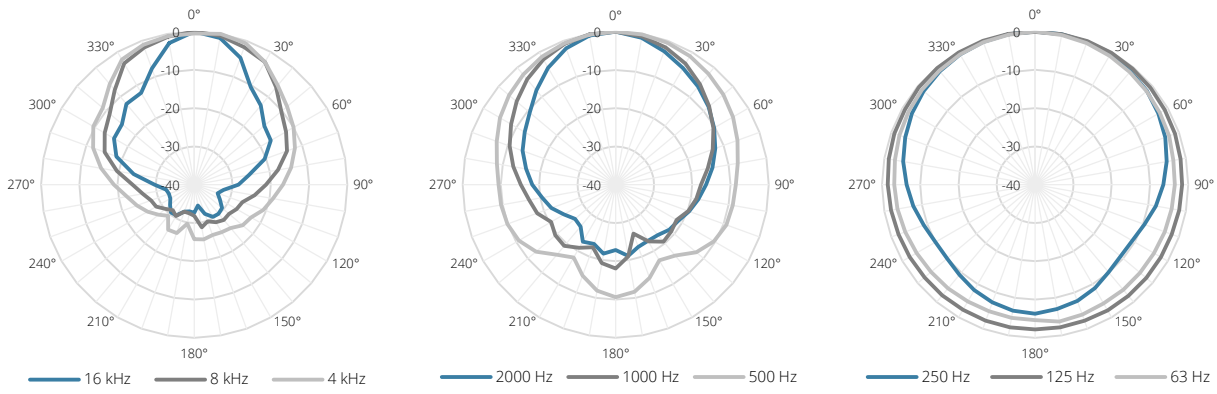

Vertical Polars:

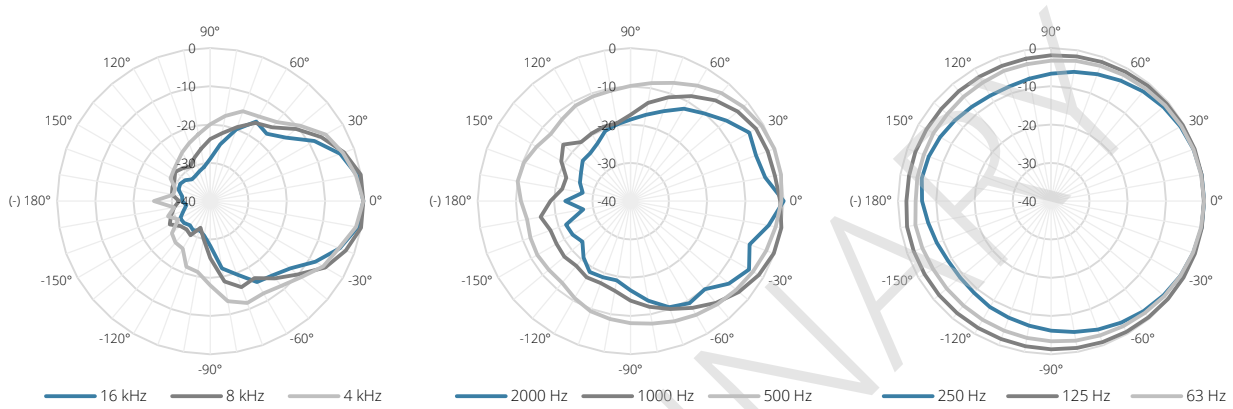

Sensitivity:

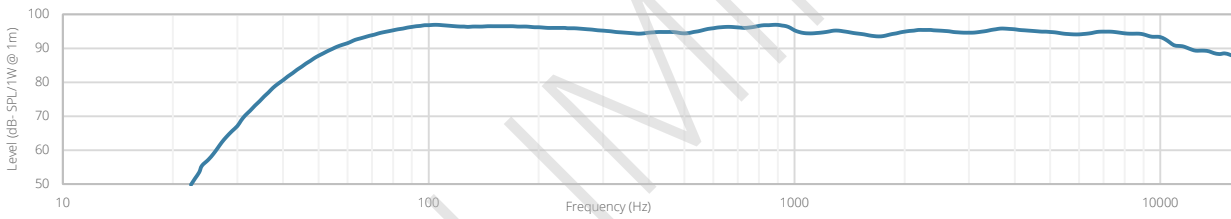

Beamwidth (-3dB):

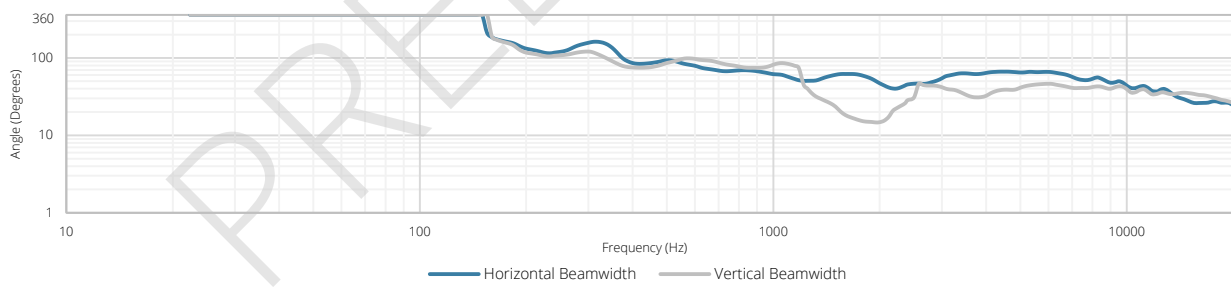

Directivity index:

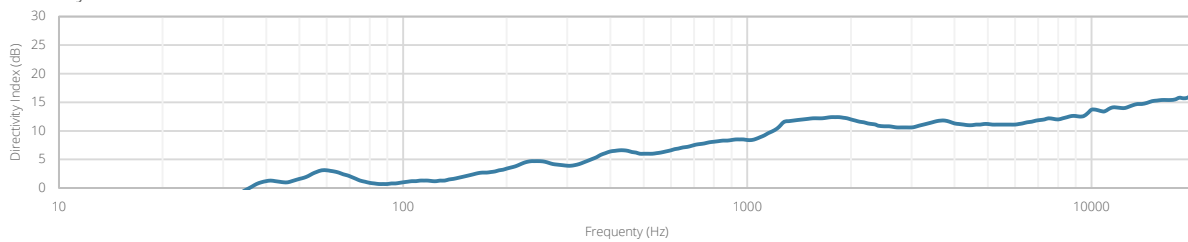

AUDAC-VEXO115(A)

2-Way 15" active speaker cabinet

PRELIMINARY

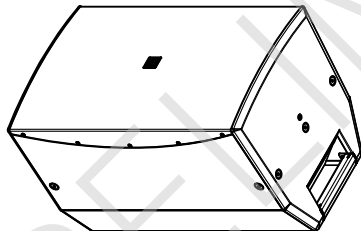
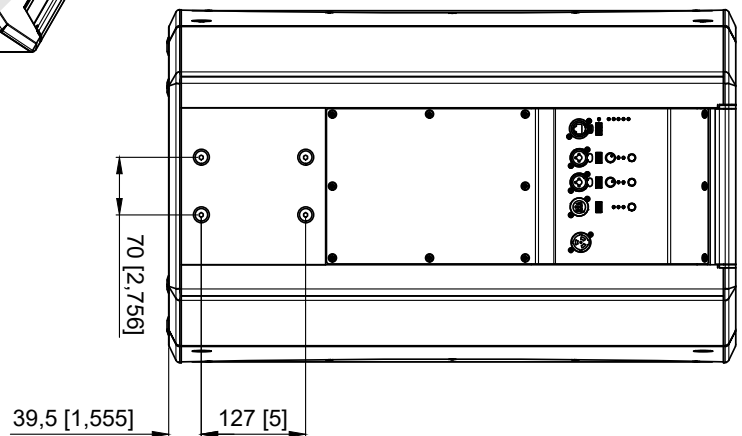
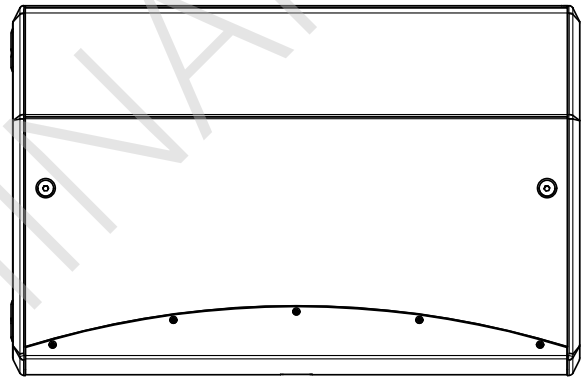
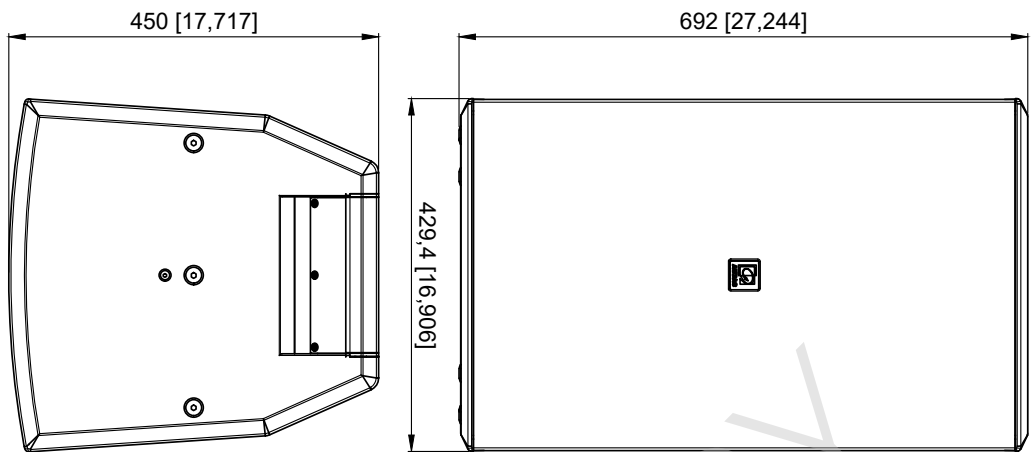

VEXO115A		Product description	
ACTIVE HIGH PERFORMANCE LOUDSPEAKER - 15"/2WAY - 500W RMS			
MM [INCH]	Weight	Outer dimensions (w x h x d)	Unit height
28,9 kg 63,7 lbs	429 x 692 x 450 mm 16,906 x 27,244 x 17,717 "	N/A	