

## 10. Maintenance and cleaning

It is absolutely essential that the fixture is kept clean and that dust, dirt and smoke-fluid residues must not build up on or within the fixture. Otherwise, the fixture's light-output will be significantly reduced. Regular cleaning will not only ensure the maximum light-output, but will also allow the fixture to function reliably throughout its life. A soft lint-free cloth moistened with any good glass cleaning fluid is recommended, under no circumstances should alcohol or solvents be used!

**DANGER !**  
**Disconnect from the mains before starting any maintenance work**

The front objective lens will require weekly cleaning as smoke-fluid tends to building up residues, reducing the light-output very quickly. The cooling-fans should be cleaned monthly.

The interior of the fixture should be cleaned at least annually using a vacuum-cleaner or an air-jet. Dichroic colour filters. Remove dust and dirt from the fans and cooling vents using a soft brush and vacuum-cleaner.

Important! Check the air filters periodically and clean before they become clogged!

Clean two air filters placed in the fixture's covers and two in the fixture base. Use a vacuum cleaner, compressed air or you can wash them and put back dry.

After replacing the air filters, reset the elapsed time counter in the menu "Information" (Information--->Air Filters--->Elapsed Time).

Replacing the fuse. Before replacing the fuse, unplug mains lead.

- 1) Remove the fuse holder on the rear panel of the base with a fitting screwdriver from the housing (anti-clockwise).
- 2) Remove the old fuse from the fuse holder.
- 3) Install the new fuse in the fuse holder (only the same type and rating).
- 4) Replace the fuseholder in the housing and fix it.

### Wireless function

1. Choose the wireless DMX on the light display  
"SET" → "Signal setting" → "Wireless DMX" (ULd showed on display)
  2. Wireless transmitter transmits signal, press "UP" and "ENTER" button at the same time on the light display until you see the indicator flashing yellow
  3. Pairing signal in transmitter, would see indicator flashing green on the light display
2. In the Use mode, Description of Status Indicator:

Protocol	Action	Status Description
W-DMXReceive Protocol	White	Connection is not Established
	Red	Deleting Connection
	Red(Fast-Flash)	Connection is Lost
	Green(Fast-Flash)	Connecting to Transmitter
	Green(Slow-Flash)	Connected, Without DMX Signal
	Green	Connected, Receiving DMX Signal



## FOS IQ Par IP65 Lime

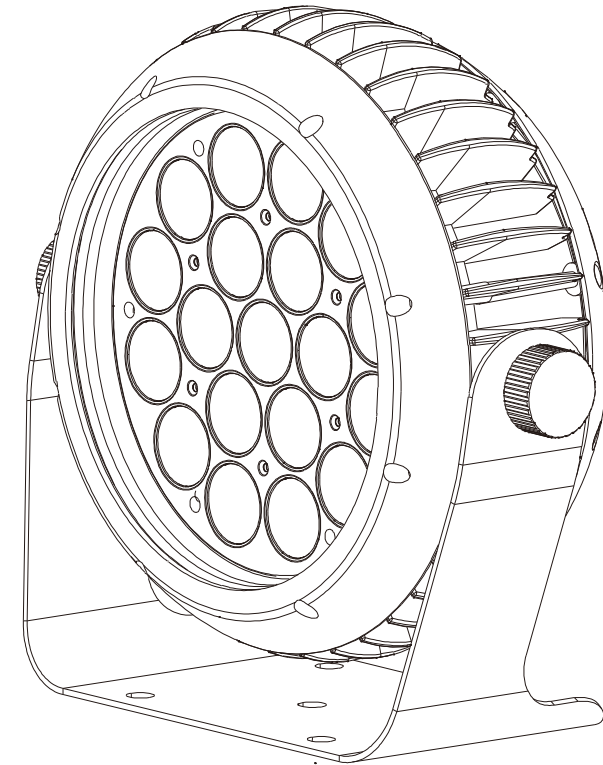

Version 1.0

# USER MANUAL

- Be sure to read the USER MANUAL carefully before using this product.
- Be sure to keep the USER MANUAL properly for future needs.
- Use this product correctly when you can fully understand the User Manual

## 1.Safety instructions

Thank you for choosing our FOS IQ Par IP65 Lime. for your own safety, please read this user manual carefully

### BEFORE YOU INITIAL START - UP!

**CAUTION!**  
**Be careful with your operations.**  
**With a high voltage you can suffer a dangerous electric shock when touching the wires!**

This device has left our premises in absolutely perfect condition. In order to maintain this condition and to ensure a safe operation, it is absolutely necessary for the user to follow the safety instructions and warning notes written in this manual.

**CAUTION!**  
**Keep this device away from rain and moisture!**  
**Unplug mains lead before opening the housing!**

### Important:

The manufacturer will not accept liability for any resulting damages caused by the non-observance of this manual or any unauthorized modification to the device.

Please consider that damages caused by manual modifications to the device are not subject to warranty.

During the operation the housing becomes hot). Allow the fixture to cool approximately 20 minutes prior to manipulate with it.

Make sure that the available voltage is not higher than stated on the rear panel.

**WARNING!** This unit does not contain an ON/OFF switch. Always disconnect power input cable to completely remove power from unit when not in use or before cleaning or servicing the fixture.

Make sure that the power-cord is never crimped or damaged by sharp edges. Check the device and the power-cord from time to time.

Always disconnect from the mains, when the device is not in use or before cleaning it. Only handle the power-cord by the plug. Never pull out the plug by tugging the power cord.

This device falls under protection class I. Therefore it is essential to connect the yellow/green conductor to earth.

The electric connection, repairs and servicing must be carried out by a qualified employee.

Do not connect this device to a dimmer pack.

Do not switch the fixture on and off in short intervals as this would reduce the lamp's life.

During the initial start-up some smoke or smell may arise. This is a normal process and does not necessarily mean that the device is defective.

Do not touch the device's housing bare hands during its operation (housing becomes hot)!

For replacement use lamps and fuses of same type and rating only.

**CAUTION ! EYE DAMAGES !**  
**Avoid looking directly into the light source**  
**(meant especially for epileptics) !**

20	8	76..105	3500K - 5000K
		106..135	5000K - 5500K
		136..165	5500K - 6000K
		166..195	6000K - 6500K
		196..225	6500K - 7000K
		226..255	7000K - 8000K
21	9		<b>Macro RUN</b>
		0..15	No function
		16..31	Macro Run 1
		32..47	Macro Run 2
		48..63	Macro Run 3
		64..79	Macro Run 4
		80..95	Macro Run 5
		96..111	Macro Run 6
		112..127	Macro Run 7
		128..143	Macro Run 8
		144..159	Macro Sound 1
		160..175	Macro Sound 2
		176..191	Macro Sound 3
		192..207	Macro Sound 4
208..223	Macro Sound 5		
224..239	Macro Sound 6		
240..255	Macro Sound 7		
22	10		<b>Macro Speed</b>
		0..255	Macro Speed from Slow To Fast

14			<b>Lime2</b>
		0..255	0-100% Lime2 dimmer from dark to bright
15			<b>Red3</b>
		0..255	0-100% Red3 dimmer from dark to bright
16			<b>Green3</b>
		0..255	0-100% Green3 dimmer from dark to bright
17			<b>Blue3</b>
		0..255	0-100% Blue3 dimmer from dark to bright
18			<b>Lime3</b>
		0..255	0-100% Lime3 dimmer from dark to bright
19	7		<b>Macro Color</b>
		0..15	No Function
		16..31	Red
		32..47	Green
		48..63	Blue
		64..79	Lime
		80..95	Red+Green
		96..111	Red+Blue
		112..127	Red+Lime
		128..143	Green+Blue
		144..159	Green+Lime
		160..175	Blue+Lime
		176..191	R+G+B
		192..207	R+G+B+L
		208..212	2700K
		213..217	3200K
		218..222	3500K
		223..227	5000K
		228..232	5500K
		233..237	6000K
238..242	6500K		
243..247	7000K		
248..255	8000K		
20	8		<b>Color Temp</b>
		0..15	No Function
		16..45	Below 3200K
		46..75	3200K - 3500K

## 2.UNPACKING

Please carefully unpack it when you receive the fixture and check whether it is damaged during the transportation. And please check whether the following items are included inside the box:

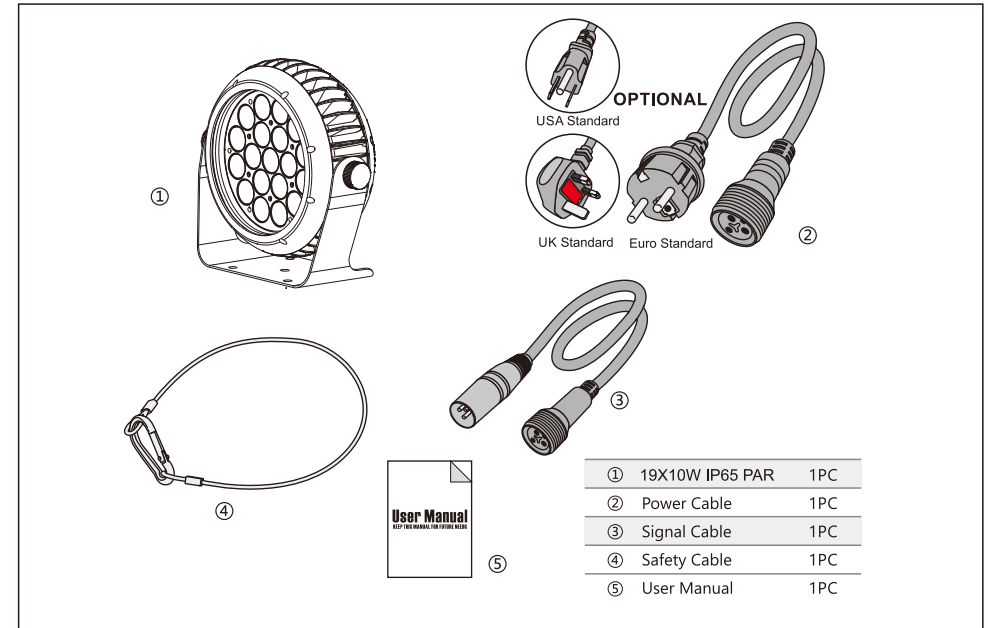

The FOS IQ Par IP65 Lime is made of a new type of high temperature strength of engineering plastics and cast aluminum casing with nice outlook . The fixture is designed and manufactured strictly following CE standards, complying with international standard DMX512 protocol. It's available independently controlled and linkable with each other for operation. And it is applicable for large-scale live performances, theater, studio, nightclubs and discos.

This manual covers the important information on installation and applications. Meanwhile, please keep this manual well for future needs.

### 3. TECHNICAL INFORMATION

#### Features

- 19\*12W 4-in-1 LEDs (RGBL)
- 50,000 hours lifespan and low power consumption
- High light output with even color mixing
- 26 degree beam angle
- 0-100% Smooth LED dimmer
- Flicker free control system for TV production and film
- High efficiency LED shutter with variable speed
- Strobe effect with 1-25T/s and pulse effect
- Built-in default programs
- Macro effects
- 22/10 DMX channels USITT MDX-512
- 4-Button LED display control menu DMX512, master-slave and sound activated controllable or auto
- Noise free efficient aluminum cooling system
- IP65 protection rating
- IP rated power connector IN/OUT
- IP rated 3-pin DMX connectors IN/OUT
- 35°C~45°C ambient temperature
- Dual mounting brackets for installation/floor stand
- WDMX operations
- 3 pixels rings

#### Specifications

- Input Voltage:** AC90-260V 50/60Hz
- LED Quantities:** 19PCS 4-IN-1 12W LEDs
- Control Signal:** DMX512, master-slave and sound activated or auto operation
- Control Channel:** 22/10 DMX Channels USITT DMX-512
- Power Consumption:** 200W
- Dimensions:** 155(D)\*299(W)\*279(H)mm
- Packing Dimensions:** 370(D)\*335(W)\*245(H)mm
- Net Weight:** 4.65kg
- Gross Weight:** 5.65kg

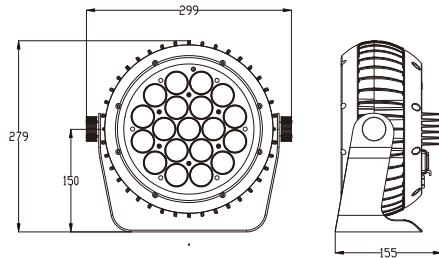

### 9. DMX PROTOCOL

Mode/Channel		Value	Function
CH22	CH10		
1	1		<b>Dimmer</b>
		0..255	Dimmer 0%...100%
2	2		<b>Shutter</b>
		0..31	Shutter closed
		32..63	shutter open
		64..95	Strobe effect slow to fast
		96..127	shutter open
		128..159	Pulse-effect in sequences slow to fast
		160..191	shutter open
		192..223	Random strobe effect slow to fast
		224..255	shutter open
3	3		<b>Red</b>
		0..255	0-100% Red dimmer from dark to bright
4	4		<b>Green</b>
		0..255	0-100% Green dimmer from dark to bright
5	5		<b>Blue</b>
		0..255	0-100% Blue dimmer from dark to bright
6	6		<b>Lime</b>
		0..255	0-100% Lime dimmer from dark to bright
7			<b>Red1</b>
		0..255	0-100% Red1 dimmer from dark to bright
8			<b>Green1</b>
		0..255	0-100% Green1 dimmer from dark to bright
9			<b>Blue1</b>
		0..255	0-100% Blue1 dimmer from dark to bright
10			<b>Lime1</b>
		0..255	0-100% Lime1 dimmer from dark to bright
11			<b>Red2</b>
		0..255	0-100% Red2 dimmer from dark to bright
12			<b>Green2</b>
		0..255	0-100% Green2 dimmer from dark to bright
13			<b>Blue2</b>
		0..255	0-100% Blue2 dimmer from dark to bright

### 8.MENU OPERATIONS

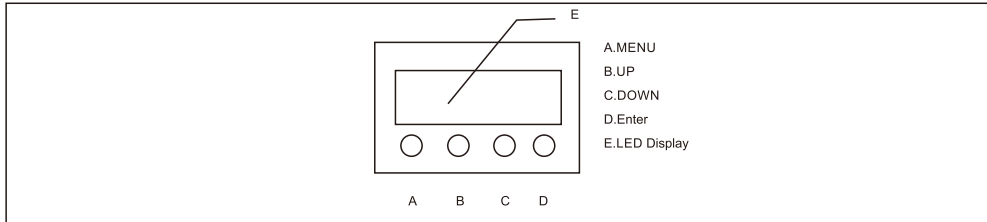

MODE	ADDR	VALU	A001 ~ AXXX (AXXX)	DMX address setting	
		SLAV		Slave setting	
	AUTO	IP1~8	ALON / (AU-A)	SP_1~ SP_5 (SPEED)	Auto alone
			MAST / (AU-M)	SP_1~ SP_5 (SPEED)	Auto Master
SOUN	IP1~7	ALON (SO-A)		Sound alone	
		MAST (SO-M)		Sound master	
SET	MIC	M-XX		Mic sensitivity setting	
	LODA	ON/OFF		Reset default	
	VER	V-2.0		Software version	
	CALI	Code (088)		Calibration code	
		CH03—CH06		Calibration channel	
	Signal Set	Wire DMX Wireless DMX Act WDMX & Out		Wire DMX Wireless DMX Act WDMX & Out	
DMX	MOD1		22CH		
	MOD2		10CH		
REST	ON/OFF		Total reset		
MANU	STROBE		000-255	Manual control-strobe	
	DIMMER		000-255	Manual control-dimmer	
	RED		000-255	Manual control-red	
	GREEN		000-255	Manual control-green	
	BLUE		000-255	Manual control-blue	
TEMP	LIME		000-255	Manual control-lime	
	TXXX			Temperature	

### 4. PHOTOMETRIC DATA

Photometric Beam Angle Data

		LUX		
		1M	3M	5M
26°	R	7589	864	311
	G	7320	905	325
	B	10256	1271	434
	L	7100	850	294
RGBL		33400	3739	1377

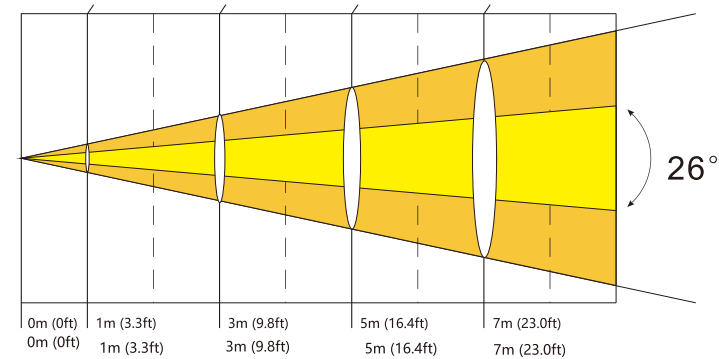

### 5. OPERATION INSTRUCTIONS

- The FOS IQ Par IP65 Lime is for beam effect for on-site decoration purpose.
- Don't turn on the fixture if it's been through severe temperature difference like after transportation because it might damage the light due to the environment changes. So make sure to operate the fixture until it is in normal temperature.
- This light should be keep away from strong shaking during any transportation or movement.
- Don't pull up the light by only the head, or it might cause damages to the mechanical parts.
- Don't expose the fixture in overheat, moisture or environment with too much dust when installing it. And don't lay any power cables on the floor. Or it might cause electronic shock to the people.
- Make sure the installation place is in good safety condition before installing the fixture.
- Make sure to put the safety chain and check whether the screws are screwed properly when installing the fixture.
- Make sure the lens are in good condition. It's recommended to replace the units if there are any damages or severe scratch.
- Make sure the fixture is operated by qualified personnel who knows the fixture before using.
- Keep the original packages if any second shipment is needed.
- Don't try to change the fixtures without any instruction by the manufacturer or the appointed

## 6. INSTALLATIONS

### Cautions:

For added protection mount the fixtures in areas outside walking paths, seating areas, or in areas where the fixture might be reached by unauthorized personnel.

Before mounting the fixture to any surface, make sure that the installation area can hold a minimum point load of 10 times the device's weight.

Fixture installation must always be secured with a secondary safety attachment, such as an appropriate safety cable.

Never stand directly below the device when mounting, removing, or servicing the fixture.

from a ceiling, or set on a flat level surface (see illustration below). Be sure this fixture is kept at least 0.5m (1.5 ft) away from any flammable materials (decoration etc.).

Always use and install the supplied safety cable as a safety measure to prevent accidental damage and/or injury in the event the clamp fails.

### Mounting points:

Overhead mounting requires extensive experience, including amongst others calculating working load limits, a fine knowledge of the installation material being used, and periodic safety inspection of all installation material and the fixture. If you lack these qualifications, do not attempt the installation yourself. Improper installation can result in bodily injury.

Be sure to complete all rigging and installation procedures before connecting the main power cord to the appropriate wall outlet.

### Clamp Mounting:

FOS IQ Par IP65 Lime provides a unique mounting bracket assembly that integrates the bottom of the base, and the safety cable rigging point in one unit (see the illustration below). When mounting this fixture to truss be sure to secure an appropriately rated clamp to the included omega bracket using a M10 screw fitted through the center hole of the "Hanging Kit". As an added safety measure be sure to attached at least one properly rated safety cable to the fixture using one of the safety cable rigging points integrated in the base assembly.

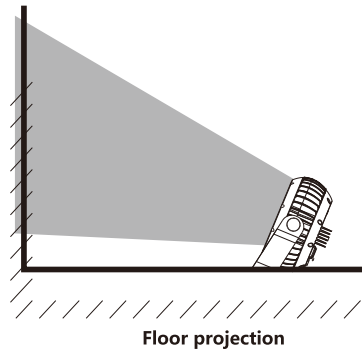
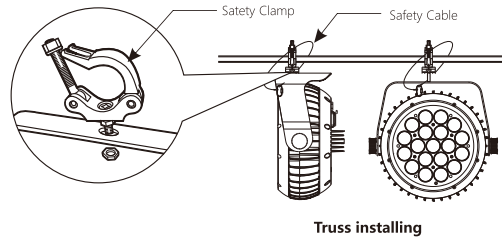

## 7. CONTROL CONNECTION

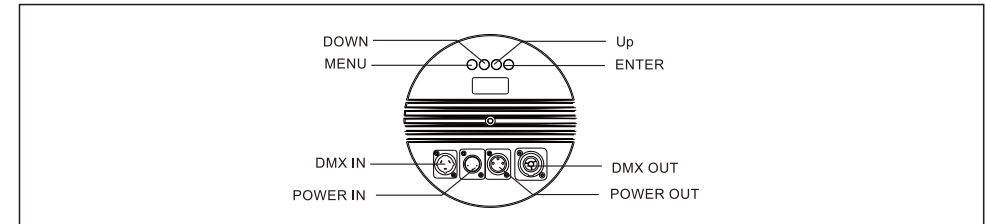

Connect the provided XLR cable to the female 3-pin XLR output of your controller and the other side to the male 3-pin XLR input of the moving head. You can chain multiple Moving head together through serial linking. The cable needed should be two core, screened cable with XLR input and output connectors. Please refer to the diagram below. DMX-512 connection with DMX terminator.

For installations where the DMX cable has to run a long distance or is in an electrically noisy environment, such as in a discotheque, it is recommended to use a DMX terminator. This helps in preventing corruption of the digital control signal by electrical noise. The DMX terminator is simply an XLR plug with a 3 resistor connected between pins 2 and 3, which is then plugged into the output XLR socket of the last fixture in the chain. Please see illustrations below.

