

RRPLASAM60/63C

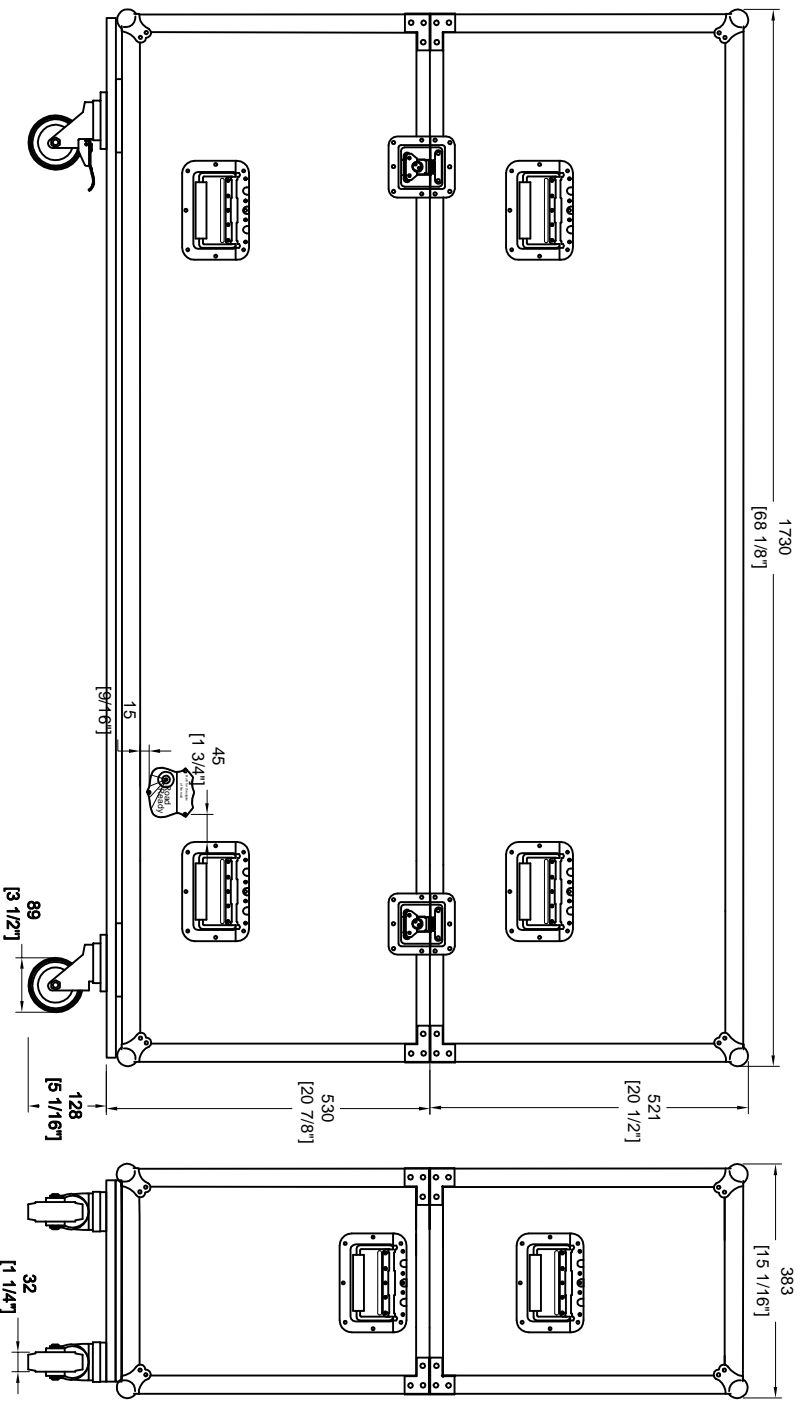

FRONT/BACK VIEW

LEFT/RIGHT VIEW

TOP VIEW



BY: **ROAD READY CASES**
 SKU: RRPLASAM60/63C
 UPC: NA
 APPROVAL SIGNATURE: _____ DATE: _____

DRAWING DATE: 06 / 17 / 2013 SCALE: 1:12 DRAWING NUMBER: 1/3 REVISION: NA

RRPLASAM60/63C

top and sides lined w/ 10mm EVA foam

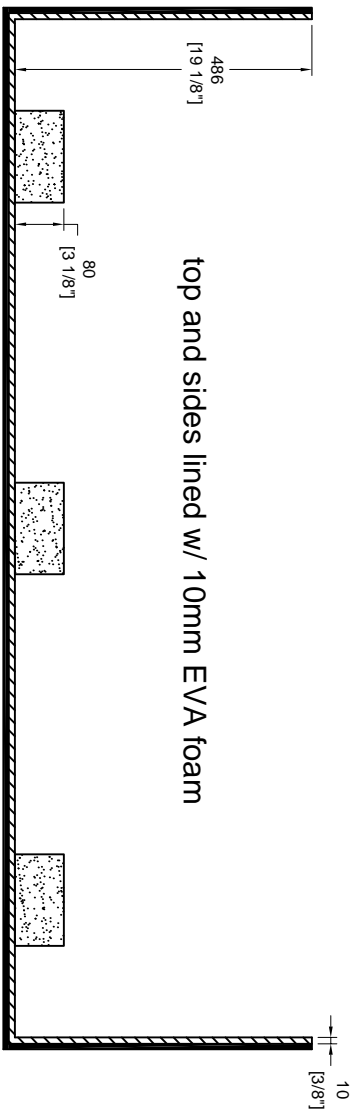

A-A VIEW

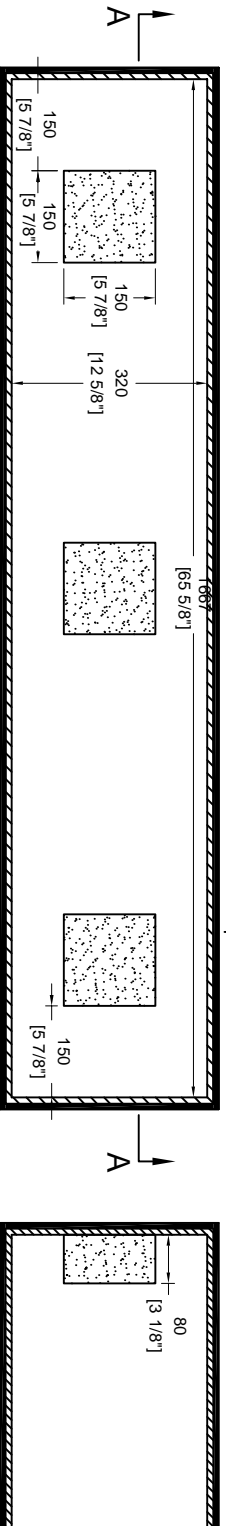

TOP VIEW OF COVER

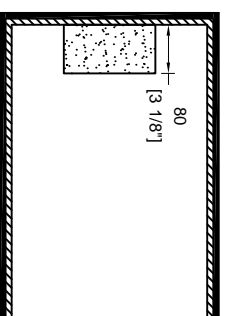

B-B VIEW



SKU: RRPLASAM60/63C	BY:	ROAD READY CASES		
UPC: NA				
APPROVAL SIGNATURE:	DATE:			
DRAWING DATE: 06 / 17 / 2013	SCALE: 1:12	DRAWING NUMBER: 2/3	REVISION: NA	

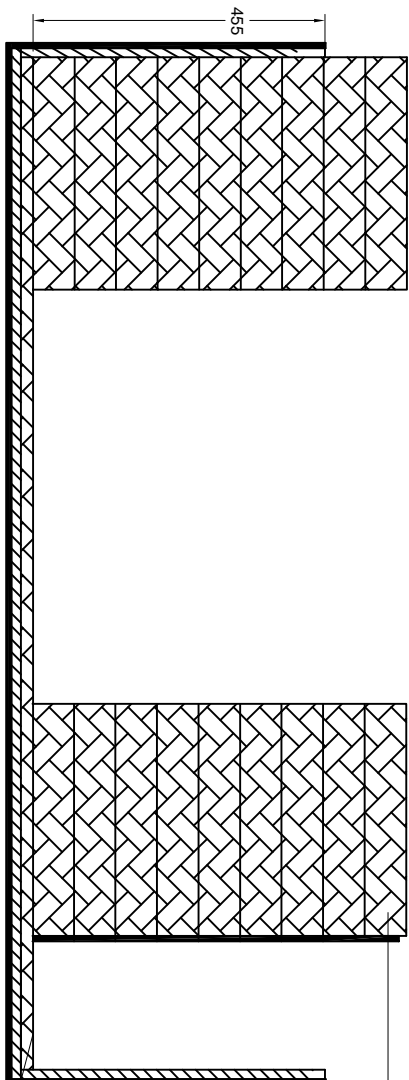

pearl foam block

RRPLASAM60/63C

C-C VIEW

bottom lined w/ 15mm EVA foam and then 20mm pearl foam+capet, sides w/ 15mm EVA foam

removable painting dot panel

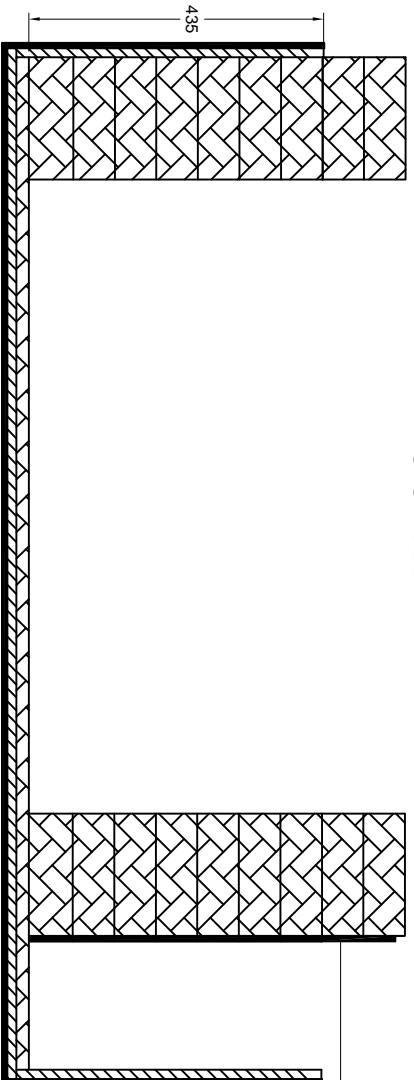

E-E VIEW

D slots with painting dot

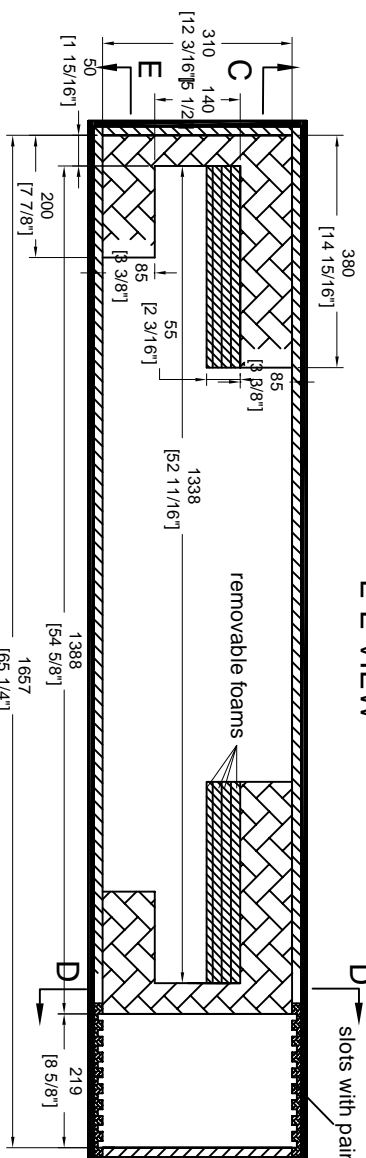

TOP VIEW OF BASE

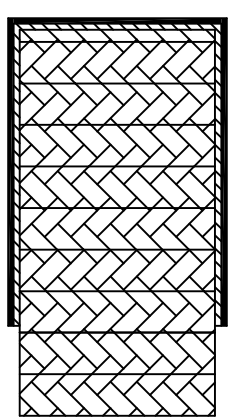

D-D VIEW



SKU: RRPLASAM60/63C	BY:	ROAD READY CASES		
UPC: NA		DATE:		
APPROVAL SIGNATURE:		DRAWING DATE:	SCALE:	DRAWING NUMBER:
		06 / 17 / 2013	1:12	3/3
				REVISION:
				NA