

RRL15

w/ 9mm plywood and small corners

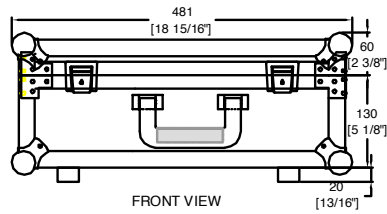

FRONT VIEW

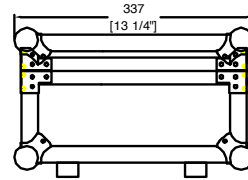

LEFT VIEW

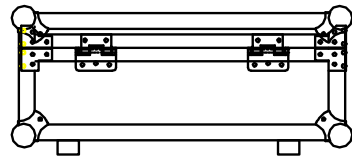

BACK VIEW

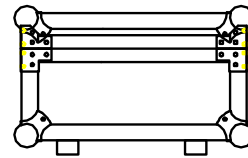

RIGHT VIEW

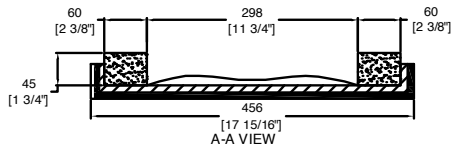

A-A VIEW

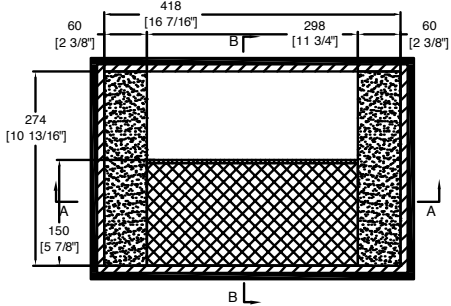
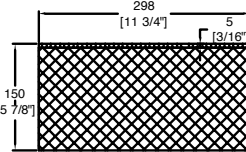

TOP VIEW OF COVER

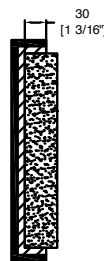

B-B VIEW

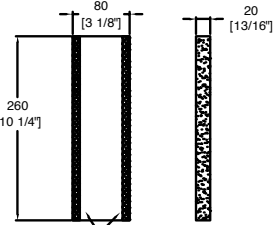

20mm thick soft foam 80*260 mm (x2pcs)

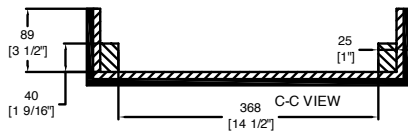

C-C VIEW

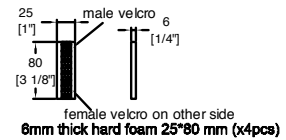

6mm thick hard foam 25*80 mm (x4pcs)

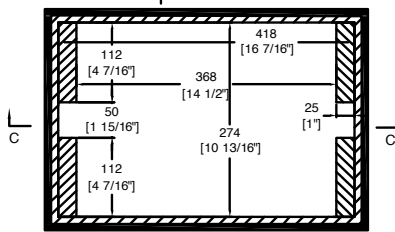

TOP VIEW OF BASE

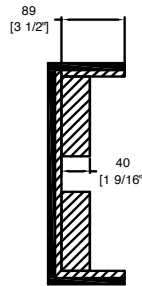

D-D VIEW

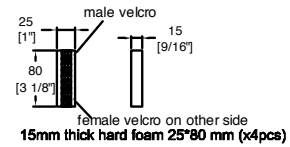

15mm thick hard foam 25*80 mm (x4pcs)

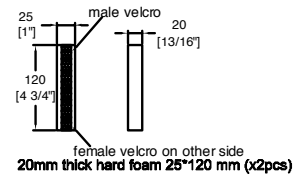

20mm thick hard foam 25*120 mm (x2pcs)

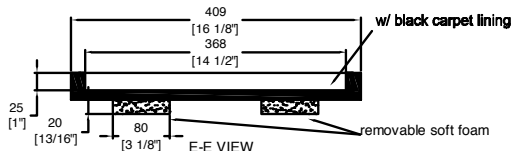

E-E VIEW

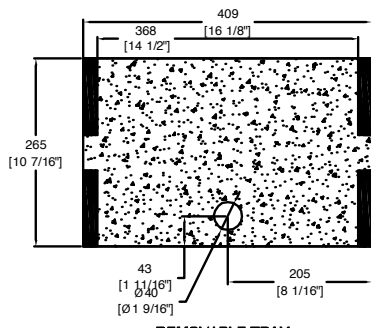

REMOVABLE TRAY

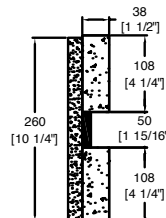

F-F VIEW

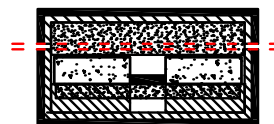

CROSS SECTION