



Catalog 2019

Flightcases
Stages
Textiles



Road Ready Cases - Catalog 2019 - v1

Subject to misprints, errors and technical modifications - No liability accepted • www.roadreadycases.be
All prices are Tax 21% included • Prices from 01/07/2019 (are subject to change)



Heavy ball-corners, stackable on one side, but always with 6 strong rivets per ball-corner.



The dj coffins are equipped with a hatch for easy cable access, as well as a cabletrap.



Solid wheel boards, always with 4 rotating casters of which 2 have brakes.



The DJ cases have removable front panels which allow the use of slot-in cd players.

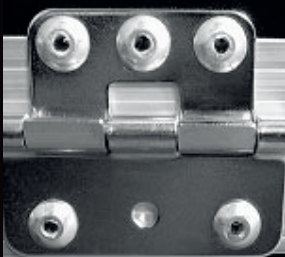

Take-apart hinges, for completely removing the lids. With years of durability.



The perfect chromed butterfly catch plays a big part in the quality of the case.



Pick and Fit foam in a number of utility cases allow for self-adjusting of the inside shape.



Fully incorporated and sturdy pull-out handles make transportation quite a bit easier.



Rack profiles, very securely mounted.

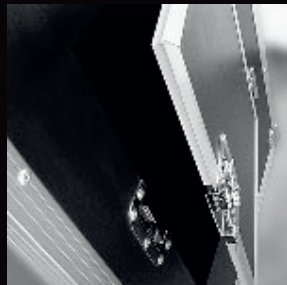

'Rear access': back door with solid butterfly catch and take-apart hinges.



Firm and specially designed flat corners: no more gaping profiles!

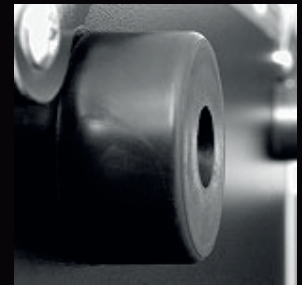

Solid rubber feet, 2 cm thick, for a firm grip.



'Shock mount', for expensive or very heavy equipment. A unique system developed by RoadReady.



The flip-out handles are from exceptional quality and perfectly flush mounted.



A few cases have an extra cable storage inside the lid.



To reach the desired strength, the edge of the wood was finished right up to the profile. The used wood is 3/8" multiplex.



In the longer cases (ex. the synthesizer cases and certain dj coffins) there are built-in wheels on one side. Very handy!



All 'universal' cases are supplied with adaptment pieces of foam for a snug fit of different types and models.



Beste Klant,

Road ready cases werd meer dan 30 jaar ontwikkeld in de VS. Ondertussen is dit een wereldbekend merk geworden van flightcases. Ondertussen werden er ook oplossingen ontwikkeld voor mobiele podia met merken als Intellistage, Proflex staging en All-terrain staging. Road Ready heeft wellicht de ruimste keuze als het gaat om kwalitatieve en innovatieve producten.

Bekijk deze catalogus en vind de juiste flightcase voor jouw gear. We zijn ook in staat op middellange termijn flightcases te ontwikkelen op maat, volgens Uw ontwerp...

Cher Client,

Road Ready s'est établie aux Etats-Unis dans les années 80. Depuis, Road Ready est devenue une marque internationale reconnue comme qualitative et innovante. Pour les podiums mobiles, la même société a conçu les marques Intellistage, Proflex staging et All-terrain staging.

Road Ready a une vaste gamme de flight cases spécialement conçue pour notre activité son et lumière. Nous sommes capables de développer de nouveaux modèles à court-terme à partir de votre design.

Dear Client,

Founded 30 years ago in the USA, Road Ready is internationally know for designing and manufacturing top quality flight cases and a full range of innovative, portable staging solutions. Their brandnames include: Road Ready, Intellistage, Proflex, Staging 101 and All-Terrain staging. Road Ready offers a full range of stock flight cases for the pro sound, DJ and lighting markets and is also capable of creating innovative, custom designs to suit their clients needs with a fast turnaround.

All flight cases come standard with a limited, lifetime warranty and are constructed of the highest grade materials

Table of contents

HARDWARE

FLIGHTCASES

- RACK CASES P. 4 - 9
- DJ CASES P. 10 - 18
- GEAR CASES P. 19 - 24
- INSTRUMENT CASES P. 25 - 27
- LIGHTING CASES P. 28 - 29
- MULTIMEDIA CASES P. 30
- UTILITY CASES P. 31 - 38
- ACCESSOIRES P. 39 - 40

TRUSS / STAGES

STAGES

- INTELLISTAGE P. 41 - 43
- PROFLEXSTAGE P. 44 - 47
- ALL TERRAIN STAGE P. 48 - 50
- FOLDING STAGE P. 51 - 52

TEXTILE

- SKIRTS FOR ALL STAGES P. 53



Modular ultra fast staging with fold-out risers for flat surfaces p. 41



Modular fast staging with individual telescopic legs for uneven undergrounds p. 44



Modular ultra sturdy staging with interconnected legs for any type of terrain p. 48



Staging 101 Slim Folding Height Adjustable Stage p. 51



Rack Cases 20cm depth

deluxe rack system with dual rack rails (front & back)

2 removable heavy-duty covers & flip out handles. The 20cm net depth is ideal for 19" effects & dynamics processors.

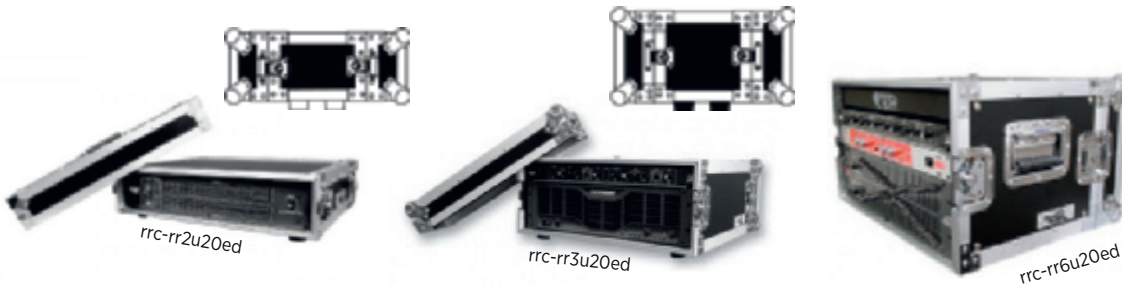

code	description	price
rrc-rr1u20ed	1U effect deluxe rack system - 20cm body depth	€ 109,-
rrc-rr2u20ed	2U 19" effect deluxe rack system - 20cm body depth	€ 119,-
rrc-rr3u20ed	3U 19" effect deluxe rack system - 20cm body depth	€ 139,-
rrc-rr6u20ed	6U 19" effect deluxe rack system - 20cm body depth	€ 179,-

Rack Cases 35 cm depth

deluxe rack system with dual rack rails (front & back)

2 removable heavy-duty covers & flip out handles. The 35cm net depth is ideal for 19" effects & dynamics processors.



code	description	price
rrc-rr1ued	1U effect deluxe rack system - 35cm body depth	€ 109,-
rrc-rr2ued	2U effect deluxe rack system - 35cm body depth	€ 129,-
rrc-rr3ued	3U effect deluxe rack system - 35cm body depth	€ 149,-
rrc-rr4ued	4U effect deluxe rack system - 35cm body depth	€ 165,-
rrc-rr6ued	6U effect deluxe rack system - 35cm body depth	€ 169,-
rrc-rr8ued	8U effect deluxe rack system - 35cm body depth	€ 179,-
rrc-rr10ued	10U deluxe effect rack system - 35cm body depth	€ 209,-
rrc-rr12ued	12U deluxe effect rack system - 35cm body depth	€ 249,-
rrc-rr14ued	14U deluxe effect rack system - 35cm body depth	€ 239,-
rrc-rr16ued	16U deluxe effect rack system - 35cm body depth	€ 279,-
rrc-rr18ued	18U deluxe effect rack system - 35cm body depth	€ 289,-
rrc-rrwed	Heavy Duty Caster Kit - 4 9cm Wheels, 2 brakes - fits effect racks	€ 81,-



Rack Cases 35cm depth value

**budget rack system with dual rack rails (front & back)**

2 removable covers & flip out handles. The 35cm net depth is ideal for 19" effects & dynamics processors.



code	description	price
rrc-rrv2ued	Value right 2U Effect rack - 35cm diep	€ 109,-
rrc-rrv4ued	Value right 4U Effect rack - 35cm diep	€ 129,-
rrc-rrv6ued	Value right 6U Effect rack - 35cm diep	€ 139,-
rrc-rrv8ued	Value right 8U Effect rack - 35cm diep	€ 145,-

Rack Cases 45 cm depth

**deluxe rack system with dual rack rails (front & back)**

2 removable heavy-duty covers & flip out handles. The 45cm net depth is ideal for 19" amplifiers.



code	description	price
rrc-rr2uad	2U amplifier deluxe rack system - 45cm body depth	€ 139,-
rrc-rr3uad	3U amplifier deluxe rack system - 45cm body depth	€ 139,-
rrc-rr4uad	4U amplifier deluxe rack system - 45cm body depth	€ 159,-
rrc-rr5uad	5U amplifier deluxe rack system - 45 cm Body depth	€ 200,-
rrc-rr6uad	6U amplifier deluxe rack system - 45cm body depth	€ 189,-
rrc-rr8uad	8U amplifier deluxe rack system - 45cm body depth	€ 179,-
rrc-rr10uad	10U amplifier deluxe rack system - 45cm body depth	€ 219,-
rrc-rr12uad	12U amplifier deluxe rack system - 45cm body depth	€ 249,-
rrc-rr14uad	14U amplifier deluxe rack system - 45cm body depth	€ 259,-
rrc-rr16uad	16U amplifier deluxe rack system - 45cm body depth	€ 269,-
rrc-rr18uad	18U amplifier deluxe rack system - 45cm body depth	€ 299,-
rrc-rrwad	Heavy Duty Caster Kit - 4 9cm Wheels, 2 brakes - fits Amp & Slant racks	€ 89,-



Rack Cases 61 cm depth

**deluxe rack system with dual rack rails (front & back)**

2 removable heavy-duty covers & flip out handles. The 61cm net depth is ideal for deep 19" amplifiers.

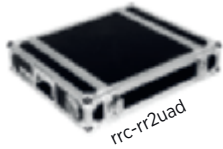

rrc-rr2uad



rrc-rr3uad

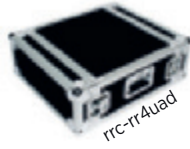

rrc-rr4uad



rrc-rr6uad



rrc-rr8uad

code	description	price
rrc-rr3uad24	3U 19" extra deep rack case, 24inch / 61cm net depth	€ 259,-
rrc-rr4uad24	4U 19 inch extra deep rack case, 24inch / 61 cm net depth	€ 269,-
rrc-rr12uad24c	12U amplifier deluxe case - 60cm body depth with caster board	€ 319,-
rrc-rr14uad24c	14U amplifier deluxe case - 60cm body depth with caster board	€ 429,-
rrc-rr16uad24c	16U Amplifier Case with caster board 61cm depth	€ 479,-
rrc-rr12uadsw	12U amplifier deluxe reack system - 45 cm body depth, shock mount w caster board	€ 399,-

Rack Cases 45 cm depth shock mount

**deluxe rack system with dual rack rails (front & back) & anti-shock suspension for extra protection**

2 removable heavy-duty covers, flip out handles & shock absorption system. The 61cm net depth is ideal for 19" amplifiers.



rrc-rr2uads



rrc-rr4uads



rrc-rr8uads



rrc-rr12uadsw



rrc-rrwads



rrc-rr18uadsw

code	description	price
rrc-rr4uads	4U amplifier deluxe rack system - 45cm body depth, shock mount	€ 259,-
rrc-rr8uads	8U amplifier deluxe rack system - 45cm body depth, shock mount	€ 299,-
rrc-rr18uadsw	18U amplifier deluxe rack system - 45cm body depth, shock mount w/ caster board	€ 529,-
rrc-rrwads	Heavy Duty Caster Kit - 4 9cm Wheels, 2 brakes - fits shock mount racks	€ 89,-



Rack Cases 19" universal



drawer rack on wheels for storing cables & other accessories

removable heavy-duty cover on the front, flip out handles & multiple drawers with dividers.

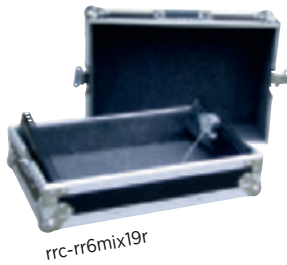

rrc-rr6mix19r



rrc-rr19mix



rrc-rr19mix

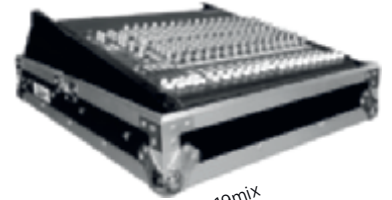

rrc-rr19mix

code	description	price
rrc-rr6mix19r	univ. 19" mixer - effect case w/ 6U deep rack rails	€ 129,-
rrc-rr19mix	19" mixer case (up to 6U) with slanted rack rails	€ 139,-
rrc-rrm19	universal 19" mixer case for non rackmountable 19" mixers	€ 135,-
rrc-rrm19r	universal 19" mixer case with rack rails	€ 149,-

Rack Cases slant 10u



combination of a vertical rack with a slanted rack on top for mixer / control panel

Perfect for mobile discobars or a 19" PA mixer with amplifier rack on the bottom. The slanted rack on top is ideal for a mixer and a CD/MP3 controller while the vertical rack houses all your 19" FX units and amplifiers. Removable, hinged door on the back for easy access to cables.



rrc-rrm2u



rrc-rrm3u



rrc-rrm4u



rrc-rrm6u



rrc-rrm8u



rrc-rrm10u



rrc-rrm12u



rrc-rrm14uw



rrc-rrm16uw

code	description	price
rrc-rrm2u	10U slant mixer rack / 2U vertical rack system	€ 159,-
rrc-rrm3u	10U slant mixer rack / 3U vertical rack system	€ 169,-
rrc-rrm4u	10U slant mixer rack / 4U vertical rack system	€ 179,-
rrc-rrm6u	10U slant mixer rack / 6U vertical rack system	€ 199,-
rrc-rrm8u	10U slant mixer rack / 8U vertical rack system	€ 209,-
rrc-rrm10u	10U slant mixer rack / 10U vertical rack system	€ 229,-
rrc-rrm12u	10U slant mixer rack / 12U vertical rack system	€ 259,-
rrc-rrm14uw	10U slant mixer rack / 14U vertical rack system with wheel board	€ 329,-
rrc-rrm16uw	10U slant mixer rack / 16U vertical rack system with wheel board	€ 359,-
rrc-rrmw	pair of side wings with 1U drawer for slant racks - fits 6U cases and up	€ 79,-



Rack Cases slant value



code	description	price
rrc-rrm3uv	value slant rack syst w soft cover 3Uvert/10Uslant	€ 149,-
rrc-rrm4uv	value slant rack syst w soft cover 4Uvert/10Uslant	€ 186,-

Rack Cases slant 11u

combination of a vertical rack with a slanted rack on top for mixer / control panel

Perfect for mobile discobars or a 19" PA mixer with amplifier rack on the bottom. The slanted rack on top is ideal for a mixer and a CD/MP3 controller while the vertical rack houses all your 19" FX units and amplifiers. Removable, hinged door on the back for easy access to cables.



*front cover doubles as attachable table with fold-out support

code	description	price
rrc-rr11m16uc	11U slant mixer rack/ 16U vertical rack system with wheels	€ 399,-
rrc-rr11m16uct	11U slant mixer rack/ 16U vertical rack system with casters and side table	€ 439,-



Rack Cases slant 12u

combination of a vertical rack with a slanted rack on top for mixer / control panel

Perfect for mobile discobars or a 19" PA mixer with amplifier rack on the bottom. The slanted rack on top is ideal for a mixer and a CD/MP3 controller while the vertical rack houses all your 19" FX units and amplifiers. Removable, hinged door on the back for easy access to cables.



code	description	price
rrc-rr12m2u	12U slant mixer rack / 2U vertical rack system	€ 189,-
rrc-rr12m4u	12U slant mixer rack / 4U vertical rack system	€ 269,-
rrc-rr12m6u	12U slant mixer rack / 6U vertical rack system	€ 269,-
rrc-rr12m8u	12U slant mixer rack / 8U vertical rack system	€ 289,-
rrc-rr12m16uc	12U slant mixer rack / 16U vertical rack system with wheels	€ 379,-
rrc-rr12mwad	9cm, optional caster kit with brakes on two wheels for large shock mount racks	€ 99,-

Rack Cases drawer case



drawer rack on wheels for storing cables & other accessories

removable heavy-duty cover on the front, flip out handles & multiple drawers with dividers.



code	description	price
rrc-rrd12uc	12U rack w/ 4 drawers; 1x4U, 2x3U, and 1x2U high w/ wheels	€ 549,-
rrc-rrd14u1c	14U rack w/ 4 drawers; 2x4U and 2x3U high w/ caster board	€ 569,-
rrc-rrd16u1c	16U rack w/ 5 drawers; 2x4U, 2x3U, and 1x2U high w/ caster board	€ 689,-

**rrc-rr10mix****€ 109,-****10" DJ mixer case with front door - for all mixers from 19,7 cm to 27,3 cm wide**

- Accommodates all 10" mixers from 19,7cm to 27,3 cm (wide) X 46,99 cm (high)
- outer dimensions: 327 x 535 x 244 mm
- inner dimensions: 278 x 485 x 210 mm
- take-out door on front side for controls/connections
- handle on top

**rrc-rr10mixl****€ 179,-****10" DJ mixer case with front door - with integrated laptop stand**

- Accommodates all 10" mixers from 19,7cm to 27,3 cm (wide) X 46,99 cm (deep)
- Integrated ventilated tilting laptop stand
- outer dimensions: 521x 318 x 229 mm
- take-out door on front side for controls/connections
- handle on top

**rrc-rr12mix****€ 119,-****12" dj mixer case - for all mixers from 25,4 cm to 32,2 cm wide**

- Accommodates all 12" mixers from 25,4 cm to 32,2 cm (wide) X 42,0 cm (high)
- outer dimensions: 382 x 482 x 226 mm
- inner dimensions: 322 x 420 x 80 mm
- handle on right side
- butterfly catch on front side with take-apart hinges on te bac

**rrc-rr12mixl****€ 199,-****12" dj mixer case - with integrated laptop stand**

- Accommodates all 12" mixers from 25,4 cm to 32,2 cm (wide) X 42,0 cm (deep)
- Integrated ventilated tilting laptop stand
- outer dimensions: 382 x 482 x 226 mm
- handle on side
- 1 butterfly catch on front side with take-apart hinges on the

**rrc-rrv12mix****€ 99,-****budget 12" dj mixer case - for all mixers from 25,4 cm to 32,2 cm wide**

- accommodates all 12" mixers from 25,4 cm to 32,2 cm (wide) X 42,0 cm (high)
- outer dimensions: 382 x 482 x 226 mm
- inner dimensions: 322 x 420 x 80 mm
- handle on right side
- butterfly catch on front side with take-apart hinges



**rrc-rr1200b****€ 129,-****uUniversal turntable deluxe case - 455 x 385 x 160 mm**

- outer dimensions: 545 x 437 x 244 mm
- handle on front side
- butterfly catches on front side (2 total) with take-apart hinges on the back
- lined with removeable foam for different sized turntables

**rrc-rrv1200b****€ 99,-****budget universal turntable deluxe case: ideal for Technics SL1200**

- outside dimensions: 545 x 437 x 244 mm
- inside dimensions: 455 x 385 x 160 mm
- handle on front side
- butterfly catches on front side (2 total) with take-apart hinges on the back
- lined with removeable foam for different sized turntables

**rrc-rrdjmw****€ 259,-****coffin for 2x turntables + a 12" mixer with wheels**

- outer dimensions: 1420 x 475 x 260 mm
- low profile wheels on left side
- handles on left and right side (2 total)
- butterfly catches on front and back sides (4 total)
- lined with adjustable, modular foam for tight fit

**rrc-rrdj12w****€ 299,-****coffin for 2x turntables in battle mode + any 12" mixer w/ wheels**

- outer dimensions: 1230 x 548 x 245 mm
- low profile wheels on left side
- handles on left, right and front side (3 total)
- butterfly catches on front and back sides (4 total)
- lined with adjustable, modular foam for tight fit

**rrc-rrdj19wmkii****€ 259,-****coffin for 2x turntables + any 19" mixer with wheels**

- outer dimensions: 1550 x 440 x 265 mm
- low profile wheels on left side
- handles on left and right side (2 total)
- butterfly catches on front and back sides (4 total)
- lined with adjustable, foam for tight fit



**rrc-rrcdp****€ 109,-****universal case for top and front loading CD players up to 35,6cm deep**

- outer dimensions: 278 x 437 x 228 mm
- take out, front access door
- handle on left side (1 total)
- butterfly catch on right side, with take-apart hinges on left side
- lined with adjustable, modular foam for tight fit

**rrc-rrccdj****€ 119,-****case for Pioneer CDJ1000 / CDJ800, Denon DNS 5000/ DNS 3000/ DNS3500**

- outer dimensions: 387 x 472 x 229 mm
- take out, front access door
- with fan on the bottom for cooling
- handle on left side
- butterfly catch on right side (1 total) with take-apart hinges on te left

**rrc-rrxdj700****€ 129,-****case for pioneer XDJ 700**

- outer dimensions: 468 x 308 x 236 mm
- fits 1x Pioneer xdj-700
- handle on the left side
- butterfly on right side, hinges on the left
- equipment in picture not included

**rrc-rrvxdj700****€ 119,-****vValue case for pioneer XDJ700**

- outside dimensions: 300 x 460 x 236 mm
- inside dimensions: 243 x 403 x 156 mm
- handle on left side (1 total)
- butterfly catch on right side, with take-apart hinges on left side
- lined with foam for tight fit of Pioneer XDJ-700 USB media

**rrc-rrxdj1000****€ 169,-****CASE FOR PIONEER XDJ1000**

- Flightcase for Pioneer XDJ-1000
- 394 x 534 x 216 mm (outer dimensions)
- Removable cover
- Butterfly catches on left & right sides
- Handle on back side
- Lined with foam for tight fit of XDJ-1000 media player



**rrc-rrcdj2000n****€ 139,-****case for Pioneer CDJ 2000NXS2**

- outer dimensions: 537x390x216mm
- take out, front access door
- handle on left side
- butterfly catch on right side (1 total) with take-apart hinges on te left
- lined with adjustable, modular foam for tight fit
- fits Pioneer CDJ2000NXS

**rrc-rrdjm900xs2****€ 139,-****case for DJM900NXS2**

- outer dimensions: 400 x 537 x 216 mm
- handle on left side
- butterfly catch on right side (1 total) with take-apart hinges on te left
- lined with adjustable, modular foam for tight fit
- fits Pioneer DJM900NXS2

**rrc-rrxdj70012****€ 239,-****case for 2x Pioneer XDJ-700 and DJM750/850/900 with wheels**

- outer dimensions: 940 x 515 x 228 mm
- fits for 2x Pioneer xdj-700 and 12" mixer such as DJM 750/850/900
- low profile wheels on left side
- handles on the left, right and front side
- butterfly catches on front and back (4 in total)

**rrc-rrcdj200012w****€ 259,-****coffin for 2x Pioneer CDJ2000/900 CD players + 12" mixer - with wheels**

- outer dimensions: 1087 x 535 x 229 mm
- 3x take out, front access doors
- low profile wheels on left side
- handles on left and right side (2 total)
- butterfly catches on left, right and back sides (4 total)

**rrc-rrcdj200012wl****€ 359,-****coffin for 2x Pioneer CDJ2000/900 + 12,5" mixer - with wheels & laptopstand**

- outer dimensions: 1087 x 523 x 231 mm
- 3x take out, front access doors
- low profile wheels on left side
- handles on left and right side (2 total)
- butterfly catches on front, and back sides (4 total)



**rrc-rrdjcdjnxs2w****€ 499,-****flightcase for Pioneer, 2 * cdj2000nexus2 +mixer djm900nexus2 (12,5").**

- With dog house for perfect management of cables.
- 6 fliphandles, 4 butterfly catches, 2 inner wheels
- outside dimensions: 1070*640*270mm

**rrc-rrcdj200019w****€ 329,-****coffin for 2x Pioneer CDJ2000/900 CD players + 19" mixer - with wheels**

- outer dimensions: 1233 x 535 x 229 mm
- 3x take out, front access doors
- low profile wheels on left side
- handles on left and right side (2 total)
- butterfly catches on left, right and back sides (4 total)

**rrc-rrdnmc6000l****€ 189,-****Case for small controllers fits ddjsb/ddj400/wego4**

- Case for small controllers.
- Fits all controllers smaller then 520*300mm
- 590 x 275 x 470 mm (outer dimensions)
- integrated folding laptop stand
- take out, front access door
- butterfly catches on left and right side (2 total)

**rrc-rrddj8001000lt****€ 229,-****fFlightcase for Pioneer DDJ 1000 with Laptop tray**

- Case for Pioneer controller ddj800 and ddj1000l with laptop tray
- 837x519x242mm (outer dimensions)
- 712x470mm inner dimensions. Inner height base : 170mm Inner height cover: 90mm
- 2 butterfly catches on front, 1 left side, 1 right side.

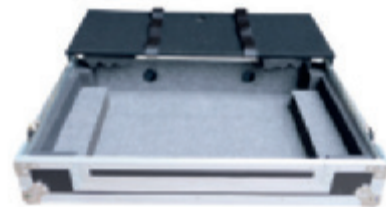
**rrc-rrddj1000lt****€ 229,-****Flightcase for Pioneer DDJ 1000 with Laptop tray**

- Case for Pioneer controller ddj1000 with laptop tray
- 837x519x242mm (outer dimensions)
- 712x470mm inner dimensions. Inner height base : 170mm Inner height cover: 90mm
- 2 butterfly catches on front, 1 left side, 1 right side.

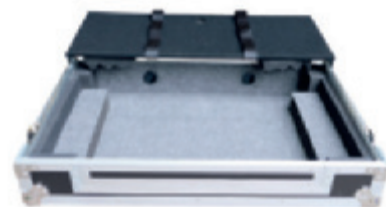



rrc-rrxdjrx

€ 249,-

Case for Pioneer XDJ-RX & XDJ-RX2 media player/controller

- outer dimensions: 821 x 505 x 251 mm
- inner dimensions: 756 x 442 x 143 mm
- butterfly catches on left, right and backside
- carry handle on side
- lined with grey carpet in cover inside
- takeout panel on front side
- lined with foam



rrc-rrxdjrxlt

€ 259,-

Case for Pioneer XDJ-RX or XDJ-RX2 controller with sliding laptop tray

- Case for Pioneer XDJ-RX system with sliding laptop tray (305mm depth)
- 869 x 521x 201 mm (outer dimensions)
- butterfly catches on left and right side
- Carry handle on back side
- Lined with grey carpet in cover inside
- Lined with foam

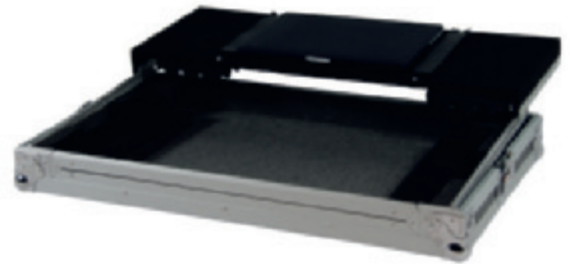

rrc-rrddjsrlt

€ 199,-

Case for Pioneer DDJSR or DDJ-RR controller with sliding laptop tray

- Case for Pioneer DDJ-SR or DDJ-RR controller with sliding laptop tray (305mm depth)
- 679 x 474 x 214 mm (outer dimensions)
- butterfly catches on left and right side
- Carry handle on back side
- Lined with grey carpet in cover inside



rrc-rrddjsx

€ 189,-

case for Pioneer DDJSX or DDJRX controller

- Case for Pioneer DDJ-SX or DDJ-RX controller
- 743 x 539 x 222 mm (outer dimensions)
- take out, front access door
- butterfly catches on left and right side (2 total), with take apart hinges on back side
- Carry handle on left and right side



rrc-rrddjsxl

€ 249,-

case for Pioneer DDJSX or DDJRX controller w/ folding laptop stand

- Case for Pioneer DDJ-SX or DDJ-RX controller
- 743 x 539 x 222 mm (outer dimensions)
- take out, front access door
- built-in folding laptop stand
- butterfly catches on left and right side (2 total), with take apart hinges on back side



**rrc-rrddjsxlt****€ 229,-****case for Pioneer DDJSX or DDJ-RX controller with sliding laptop tray**

- Case for Pioneer DDJ-SX or DDJ-RX controller
- sliding laptop tray (305mm depth)
- 789 x 491 x 203 mm (outer dimensions)
- butterfly catches on left and right side (2 total)
- Carry handle on back side (1 total)
- Lined with grey carpet

**rrc-rrddjsz****€ 219,-****case for Pioneer DDJSZ or DDJ-RZ controller**

- Case for Pioneer DDJ-SZ or DDJ-RZ controller
- 940 x 585 x 226 mm (outer dimensions)
- take out, front access door
- butterfly catches on front and back side (4 total)
- Carry handle on left, right and back side (3 total)

rrc-rrddjszlt**€ 289,-****case for Pioneer DDJSZ or DDJRZ controller with sliding laptop tray**

- Case for Pioneer DDJ-SZ or DDJ-RZ controller
- with sliding laptop tray (305mm depth)
- 995 x 568 x 227mm (outer dimensions)
- butterfly catches on left and right side + 2x on back side
- Carry handles on left, right & back side (3 total)

rrc-rrddjszwl**€ 269,-****case for Pioneer DDJSZ or DDJ-RZ with low profile wheels and laptop stand**

- Case for Pioneer DDJ-SZ or DDJ-RZ controller
- built-in folding laptop stand
- low profile wheels on left side
- 940 x 585 x 241 mm (outer dimensions)
- take out, front access door
- butterfly catches on front and back side (4 total)

**rrc-rrddjrxt****€ 339,-****case for Pioneer DDJ-RZX**

- outer dimensions: 1068x699x234mm
- handle on left and right side
- butterfly catches on left and right and front side (4 total)
- small built-in wheels on left side
- lined with adjustable, modular foam for tight fit
- with sliding laptop





rrc-rrsc5000

€ 149,-

case for Denon SC5000

- outer dimensions: 390 x 542 x 229 mm
- inner dimensions: 327 x 479 x 154 mm
- handle on left side
- butterfly catches on right side (1 total)
- lined with foam for a tight fit of the Denon SC5000 media player



rrc-rrx1800

€ 149,-

case for Denon X1800

- outer dimensions: 379 x 567 x 229 mm
- inner dimensions: 316 x 504 x 154 mm
- handle on left side
- butterfly catches on right side (1 total)
- lined with foam for a tight fit of the Denon X1800 dj mixer



rrc-rrdnmcx8000

€ 199,-

case for DNMCX8000

- lined with adjustable, modular foam for tight fit
- fits Denon MCX8000

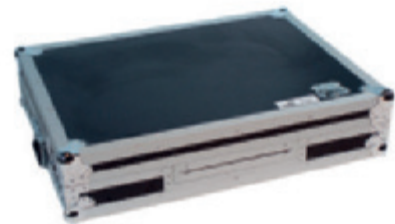

rrc-rrprime4

€ 249,-

flightcase for Denon DJ controller prime 4

- with removable front
- overall outside diameter: 804*660*260mm

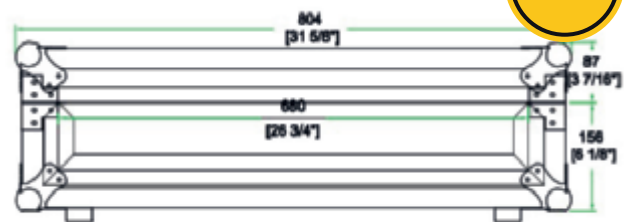

FRONT VIEW



rrc-rrcd100

€ 129,-

deluxe cd case, holds 100 jewel case CD's

- outer dimensions: 672 x 413 x 207 mm
- fits up to 100 CD's in jewel cases or 400 CD's in view packs
- divided into 4 rows
- handle on front side
- butterfly catches on front side (2 total) with take-apart hinges on the back
- lined with lined with soft foam for protection



**rrc-rrcd100hw****€ 159,-****deluxe cd case, holds 100 jewel case CD's - with pull-out handle, wheels**

- outer dimensions: 545 x 412 x 257 mm
- fits up to 100 CD's in jewel cases or 400 CD's in view packs
- smart storage compartment for all your messy accessories
- divided into 3 rows
- handle on front side
- butterfly catches on front side

**rrc-rrcd200hw****€ 219,-****deluxe cd case, holds 200 jewel case CD's - with pull-out handle, wheels**

- outer dimensions: 545 x 412 x 422 mm
- fits up to 200 CD's in jewel cases
- top-2-bottom design with removable door on cover
- smart storage compartment for all your messy accessories
- divided into 2x3 rows
- handle on front side

**rrc-rrcd400w****€ 289,-****deluxe cd case, holds 400 jewel case CD's with wheels**

- outer dimensions: 1602 x 552 x 212 mm
- fits up to 400 CD's in jewel cases or 800 in view packs
- divided into 10 rows
- handle on front, left and right side
- butterfly catches on front and back sides (4 total)
- low profile wheels





rrc-rrm12s

€ 119,-

microphone case for 12 mics with storage compartment

- microphone case for 12 mics or 6 mics with extra accessories
- soft foam with pre-cut holes
- extra storage compartment in removable top cover
- outer dimensions: 397 x 293 x 408 mm
- handle on top lid (1 total)
- butterfly catch



rrc-rrm18s

€ 149,-

microphone case for 18 mics with storage compartment

- microphone case for 18 mics or 6 or 12 mics with extra accessories
- soft foam with pre-cut holes
- extra storage compartment in removable top cover
- outer dimensions: 555 x 286 x 391 mm
- handle on top lid (1 total)
- butterfly catches



rrc-rrvm12S

€ 99,-

Case for 12 mics + accessory storage in lid

lid



rrc-rrvm18S

€ 119,-

Case for 18 mics + accessory storage in lid



rrc-rrwm4u

€ 179,-

4U 19" Rackmount wireless case with handheld mic storage in covers

- 4-unit rack system
- 2 removeable covers (front and back) with velcro straps and pick&fit foam to store handheld mics
- Dual rack rails (front and back)
- Outer dimensions: 548x543x236 mm
- Inner depth: 269mm, Inner depth covers: 92mm



**rrc-rrwm6u****€ 199,-****6U 19" Rackmount wireless case with handheld mic storage in covers**

- 6-unit rack system
- 2 removeable covers (front and back) with velcro straps and pick&fit foam to store handheld mics
- Dual rack rails (front and back)
- Outer dimensions: 548x543x325 mm
- Inner depth: 269mm, Inner depth covers: 92mm

**rrc-rrmicstandw****€ 399,-****Case for 16x microphone stands - with wheels**

- case for 16x microphone stand
- with wheels
- Hinged lid
- Cut-out for easy access
- Outside: 1140 x 460 x 460 mm (without wheels)
- Inside: 1100 x 440 x 440 mm

**rrc-rrstw****€ 179,-****trunk case for stands**

- outer dimensions: 1210 x 317 x 328 mm
- inner dimensions: 1170 x 284 x 288 mm
- low profile wheels on left side
- handle on left and right side
- butterfly catches (2) on front and hinges on the back

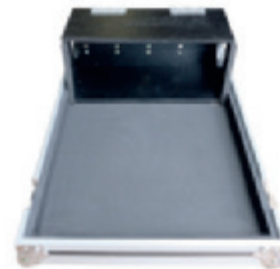
**rrc-rrsq5dh****€ 279,-****Case for Allen & Heath SQ5 with doghouse****rrc-rrsq6dh****€ 289,-****Case for Allen & Heath SQ6 with doghouse**

**rrc-rrqu16****€ 209,-****Case for Allen & Heath QU16 digital mixer**

- outside dimensions: 508 x 653 x 298 mm
- inside dimensions: 445 x 585 x X 226
- handles on front and back side (2 total)
- multiple butterfly catches on left and right side (4 total)
- lined with foam for a tight fit of the A&H QU16 digital

**rrc-ccx32cpqu24****€ 289,-****Case for Behringer X32 compact or Allen & Heath QU24 digital mixers**

- outer dimensions: 699 x 653 x 278 mm
- multiple handles on left and right side (4 total)
- butterfly catches on front and back side (4 total)
- lined with foam for a tight fit of the Behringer X32 compact or A&H QU24

**rrc-rrqu24dhc****€ 509,-****Case for Allen & Heath QU24 digital mixer with doghouse**

- outside dimensions: 938 x 710 x 330 mm
- doghouse for easy acces to connections & cable management
- handles on front, back left and right side (8 total)
- multiple butterfly catches on bottom, top left and right side (4 total)
- lined with

**rrc-ccqu32w****€ 369,-****Case for Allen & Heath QU32 digital mixer with wheels**

- outer dimensions: 924 x 653 x 283 mm
- low profile wheels on one side
- multiple handles on front, left and right side (6 total)
- butterfly catches on front and back side (4 total)
- lined with foam for a tight fit of the A&H QU32

**rrc-rrsl16****€ 249,-****case for Presonus Studio Live 16.4.2**

- outer dimensions: 711 x 536 x 253 mm
- inner dimensions: 648 x 473 x 188 mm
- handle on sides (2 total)
- 2 butterfly catches on frontside (4 total)
- lined with foam for a tight fit of the Presonus Studio Live 16.4.2



**rrc-rrs124****€ 259,-****case for Presonus Studio Live 24.4.2**

- outer dimensions: 787 x 703 x 254 mm
- inner dimensions: 724 x 640 x 178 mm
- handle on front and backside (2 total)
- 2 butterfly catches on left and right side (4 total)
- lined with foam for a tight fit of the Presonus Studio Live 24.4.2

**rrc-rrx32w****€ 329,-****case for Behringer X32 mixer with low profile wheels**

- outer dimensions: 978 x 681 x 313 mm
- inner dimensions: 905 x 608 x 236 mm
- 3 handles on right side, 2 handles on left side
- butterfly catches on front and back (4 in total)
- low profile wheels on left side
- fits Behringer x32

**rrc-rrm32dhc****€ 599,-****case for Midas M32 mixer with dog house & wheels**

- outer dimensions: 1045 x 1096 x 425mm
- inner dimensions: 980 x 837 x 410mm
- 2 handles on front and back side, 3 handles on left and right side (10 total)
- butterfly catches on all sides (6 in total)
- low profile wheels on bottom

**rrc-rrvss10****€ 159,-****flightcase voor Soundcraft Signature10**

- outer dimensions: 373 x 508 x 206 mm
- inner dimensions: 318 x 453 x 155 mm
- handle on front and back side (2 total)
- butterfly catches on left and right side (2 total)
- lined with foam for a tight fit of the Soundcraft Signature 10 mixer

**5mm**
lightweight
plywood**rrc-rrvss12****€ 169,-****flightcase voor Soundcraft Signature12**

- outer dimensions: 448 x 508 x 206 mm
- inner dimensions: 393 x 453 x 155 mm
- handle on front and back side (2 total)
- butterfly catches on left and right side (2 total)
- lined with foam for a tight fit of the Soundcraft Signature 12 mixer

**5mm**
lightweight
plywood

**rrc-rrvss16****€ 189,-****flightcase voor Soundcraft Signature16**

- outer dimensions: 565 x 618 x 206 mm
- inner dimensions: 493 x 510 x 155 mm
- handle on front and back side (2 total)
- butterfly catches on left and right side (2 total)
- lined with foam for a tight fit of the Soundcraft Signature 16 mixer

5mm
lightweight
plywood**rrc-rrvss22****€ 189,-****flightcase voor Soundcraft Signature22**

- outer dimensions: 720 x 618 x 206 mm
- inner dimensions: 665 x 563 x 155 mm
- handle on front, left and right side (3 total)
- butterfly catches on front and back side (4 total)
- lined with foam for a tight fit of the Soundcraft Signature 2

5mm
lightweight
plywood**rrc-rrremx****€ 119,-****case for Yamaha EMX 62M/212S/312SC/512SC mixers - economy version**

- case for Yamaha EMX 62M/212S/312SC/512SC mixers
- outer dimensions: 555 x 376 x 371 mm
- handles on, left and right side (2 total)
- butterfly catches on left and right side (2 total)
- lined with foam for a tight fit

**rrc-rrremx5014****€ 149,-****case for Yamaha EMX5014C MIXER**

- case for Yamaha EMX5014C mixer
- outer dimensions: 501 x 613 x 231mm
- handles on, front and back side (2 total)
- butterfly catches on left and right side (2 total)
- lined with foam for a tight fit

**rrc-rrmg16e****€ 119,-****case for Yamaha MG 16/4 & MG16/6FX mixer - (economy version)**

- outer dimensions: 494 x 534 x 159 mm
- inner dimensions: 420 x 480 x 100 mm
- handle on front side (1 total)
- butterfly catches on left and right side (2 total)
- lined with foam for a tight fit of the Yamaha MG 16/4 & MG16/6FX mixers





rrc-rr2art315w

€ 349,-

case for 2 x rcf art 312, 315 with wheels

- Flightcase for 2 X RCF ART 312, 315 with wheels
- divided in two rooms of 35*415*(120+590)mm
- overall outside dimensions without wheels: 802*478*785mm
- lined with 10mm foam
- 4 wheels, 4 handles



rrc-rr2art735w

€ 379,-

case for 2 x rcf art 715, 735, 745 with wheels

- Case for 2 X RCF ART 715, 735, 745 with wheels
- dimensions of the 2 compartments 395*450*(605+120)
- Overall outside dimensions without wheels: 882*513*800mm
- lined with 10mm foam
- 4 wheels, 4 fliphandles



rrc-rrsub8003w

€ 379,-

case for 1 x rcf sub8003 with wheels

- Flightcase for RCF sub 8003 (the sub has no wheels)
- inner dimensions: 713*530*(600+120) mm
- Overall outside dimensions without wheels: 776*593*795mm
- lined with 10mm foam
- 4 wheels, 4 fliphandles



rrc-rr2srm450c

€ 409,-

case for 2x mackie srm450 speakers w/ wheels

- fits 2x Mackie HD1221 wedge speakers
- outer dimensions: 855 x 463 x 765 mm
- divided into two compartments
- handles on left and right side of lid (4 total)
- butterfly catches on front and back side (4 total)
- big, sturdy wheels



rrc-rrkb61w

€ 209,-

61-key keyboard case with wheels - adjustable size (inside)

- 61-key Keyboard case with z-lock foam
- hinged lid with protection straps
- outer dimensions: 1252 x 509 x 247 mm
- handles on front, left and right side (3 total)
- butterfly catches on front side (2 total)
- low profile wheels on left side





rrc-rrkb76w

€ 229,-

76-key keyboard case with wheels - adjustable size (inside)

- 76-key Keyboard case with z-lock foam
- hinged lid with protection straps
- outer dimensions: 1434 x 509 x 247 mm
- handles on front, left and right side (3 total)
- butterfly catches on front side (2 total)
- low profile wheels on left side



rrc-rrkb88cw

€ 259,-

88-key keyboard case with wheels - adjustable size (inside)

- 88-key Keyboard case with z-lock foam
- hinged lid with protection straps
- outer dimensions: 1610 x 220 x 505 mm
- handles on front, left and right side (3 total)
- butterfly catches on front side (2 total)
- low profile wheels on left side



rrc-rrkb88w

€ 269,-

88-key keyboard case with wheels - adjustable size (inside)

- 88-key Keyboard case with z-lock foam
- hinged lid with protection straps
- outer dimensions: 1610 x 633 x 247 mm
- handles on front, left and right side (3 total)
- butterfly catches on front side (2 total)
- low profile wheels on left side



rrc-rrlpaul

€ 29,-

custom foam insert for RRGTR - for Gibson Les Paul guitar



rrc-rrstrat

€ 29,-

custom foam inserts for RRGTR - Snuggly fits your fender stratocaster

custom foam inserts for RRGTR - Snuggly fits your fender stratocaster



**rrc-rrg412c****€ 359,-****case for 4x 12 guitar combo - length & depth adjustable with wheels**

- case for mesa boogie 4x12 tq and Marshall 1960 4x12 guitar combos
- outside dimensions: 870 x 510 x 928 mm
- length adjustable from: 67,3 to 82,3 cm (inner)
- depth adjustable from: 31,1 to 46,1 cm (inner)
- handles on left and right side

**rrc-rrgc212c****€ 319,-****case for guitar combos with 2 X 12" speakers - adjustable inside with wheels**

- case for guitar combo's with 2x12" speakers
- outside dimensions: 842 x 435 x 843 mm
- length adjustable from: X to X cm (inner)
- depth adjustable from: X to X cm (inner)
- handles on left and right side (2 total)
- butterfly catches

**rrc-rrhrdc****€ 239,-****case for fender Hot Rod Deville 2x12 guitar amp with wheels**

- fits fender Hot Rod Deville 2x12" guitar amp
- outer dimensions: 676 x 330 x 742 mm
- handles on left and right side of lid (2 total)
- butterfly catches on left and right side (2 total)
- big, sturdy wheels on bottom

**rrc-rrgal****€ 289,-****universal large guitar amplifier case - length & depth adjustable with wheels**

- large guitar amplifier case
- outside dimensions: 869 x 452 x 656 mm
- length adjustable from: 50,4 to 82,2 cm (inner)
- depth adjustable from: 23,0 to 40,7 cm (inner)
- handles on left and right side (2 total)
- butterfly catches

**rrc-rrgal32****€ 249,-****universal guitar head case - adjustable inside to fit most amp heads**

- universal amp head case
- outside dimensions: 851 x 401 x 406 mm
- minimum inside dimensions: 508 x 124 x 254 mm
- maximum inside dimensions: 813 x 356 x 356 mm
- fits most of Marshall, Vox, Fender, Ampeg, Peavy... heads
- handles





rrc-rrgp17

€ 129,-

lightweight 43,2cm adjustable pedal board with cable routing channels

- lightweight 17inch slanted pedal board
- cable routing channels
- adjustable blocks for pedal placement customization
- outside dimensions: 463 x 471 x 199mm
- handle on front side (1 total)
- butterfly catches on left and right side



rrc-rrgp24

€ 139,-

lightweight 61cm adjustable pedal board case with cable routing channels

- lightweight 24inch slanted pedal board
- cable routing channels
- adjustable blocks for pedal placement customization
- outside dimensions: 637 x 481 x 199mm
- handle on front side (1 total)
- butterfly catches on left and right side

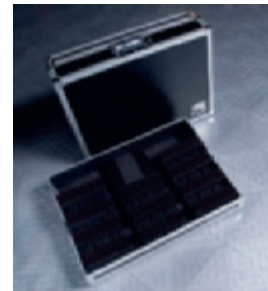

rrc-rrgp32

€ 159,-

lightweight 81,3cm adjustable pedal board case with cable routing channels

- lightweight 32inch slanted pedal board
- cable routing channels
- adjustable blocks for pedal placement customization
- outside dimensions: 841 x 481 x 199mm
- handle on front side (1 total)
- butterfly catches on left and right side

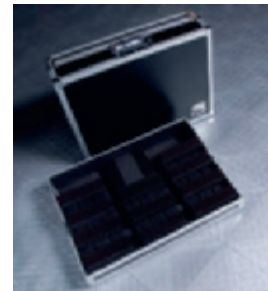

rrc-rrgp32hw

€ 209,-

lightweight 81,3cm pedal board case with pull-out handle & wheels

- lightweight 32inch slanted pedal board
- cable routing channels
- adjustable blocks for pedal placement customization
- outside dimensions: 841 x 481 x 199mm
- handle on front side (1 total)
- butterfly catches on left and right side



rrc-rrgp32w

€ 169,-

lightweight 81,3cm adjustable pedal board case with low profile wheels

- lightweight 32inch slanted pedal board
- cable routing channels
- adjustable blocks for pedal placement customization
- outside dimensions: 841 x 481 x 199mm
- handle on front side (1 total)
- butterfly catches on left and right side





rrc-rr4lc

€ 109,-

universal case for lighting controller / mixer with 19 inch, 4U slant rack

- fits almost any 19" lighting controller
- 4 Unit slant rack
- outer dimensions: 560 x 240 x 170 mm
- handle on top side of lid (1 total)
- butterfly catches on left and right side (2 total)



rrc-rr8lc

€ 129,-

universal case for lighting controller / mixer with 19 inch, 8U slant rack

- fits almost any 19" lighting controller or mixer
- 8 Unit slant rack
- outer dimensions: 560 x 420 x 170 mm
- handle on front side of lid (1 total)
- butterfly catches on left and right side (2 total)
- fits Denon DNMC6000 controller



rrc-rrekspo200w

€ 529,-

case for 12x ekspo200 led - with wheels

- case for 12x EKSP0200 LED
- with wheels



rrc-rripwash600w

€ 599,-



Road ready case for ipwash600w

- case for rripwash600w
- 1200x600x500mm (outer dimensions)
- 1166x522mm inner dimensions. Inner height base : 352mm Inner height cover: 110mm
- 2 butterfly catches on front
- Carry handle on all sides
- Trunk flightcase stackable



rrc-rrspot3w

€ 599,-



Road ready flightcase for Spot3w

- case for Spot3w
- 1200x600x600mm (outer dimensions)
- 1166x566mm inner dimensions. Inner height base : 452mm Inner height cover: 110mm
- 2 butterfly catches on front
- Carry handle on all sides
- Trunk flightcase stackable 1200x600x753 wi

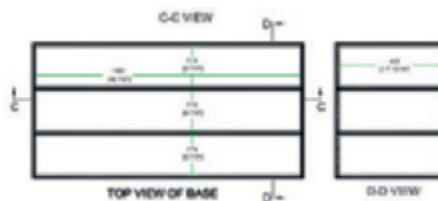

**rrc-rrspot8w****€ 599,-****Road ready flightcase for Spot8w**

- case for Spot8w
- 1200x600x600mm (outer dimensions)
- 1166x566mm inner dimensions. Inner height base : 452mm Inner height cover: 110mm
- 2 butterfly catches on front
- Carry handle on all sides
- Trunk flightcase stackable 1200x600x753

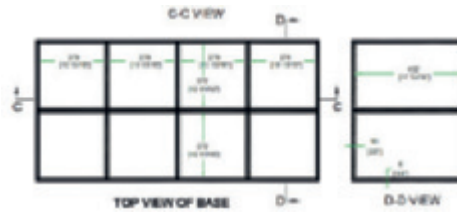
**rrc-rrl15****€ 129,-****case for 2x 15 inch laptops - 481 x 337 x 210 mm (outside)**

- fits 2x 15" laptops or one 15 inch laptop and power unit/small dj controller
- outer dimensions: 481 x 337 x 210 mm
- divided into two compartments with foam separation
- handle on front side (1 total)
- lockable draw bolts on front side

**rrc-rrl17****€ 149,-****case for 2x 15 inch laptops - 549 x 353 x 220 (outside)**

- fits 2x 17" laptops or one 17 inch laptop and power unit/small dj controller
- outer dimensions: 549 x 353 x 220 mm
- divided into two compartments with foam separation
- handle on front side (1 total)
- lockable draw bolts on front side

**rrc-rrlaptop15****€ 135,-****universal briefcase for 15" laptop with storage compartment**

- universal briefcase for 15" laptop or small controller
- with storage compartment
- mesh accessory pockets
- outside dimensions: 433 x 330 x 171 mm
- handle on front side (1 total)
- lockable draw bolts on front side (2 total) with hinge

**rrc-rrlaptop17****€ 139,-****universal briefcase for 17" laptop with storage compartment**

- universal briefcase for 17" laptop or small controller
- with storage compartment
- mesh accessory pockets
- outside dimensions: 466 x 358 x 171 mm
- handle on front side (1 total)
- lockable draw bolts on front side (2 total) with hinge





rrc-rrplasma42c

€ 489,-

universal case for - 42" monitor / plasma with wheels

- universal case for 42" monitor / tv
- outside dimensions: 1262 x 382 x 951 mm
- multiple handles on all 4 sides (12 total)
- butterfly catches on front and back side (4 total)
- lined with protective foam for tight fit
- minimum display



rrc-rrplasma50c

€ 549,-

universal case for - 50" monitor / plasma with wheels

- universal case for 50" monitor / tv
- outside dimensions: 1503 x 382 x 1118 mm
- multiple handles on all 4 sides (12 total)
- butterfly catches on front and back side (4 total)
- lined with protective foam for tight fit
- minimum display



rrc-rrplasma60/63c

€ 619,-

universal case for - 60/63" monitor / plasma with wheels

- universal case for 50" monitor / tv
- outside dimensions: 1730 x 382 x 1179 mm
- multiple handles on all 4 sides (12 total)
- butterfly catches on front and back side (4 total)
- lined with protective foam for tight fit
- minimum display



rrc-rrplasma65c

€ 669,-

universal case for - 65" monitor / plasma with wheels

- universal case for 65" monitor / tv
- outside dimensions: 1837 x 382 x 1337 mm
- multiple handles on all 4 sides (12 total)
- butterfly catches on front and back side (4 total)
- lined with protective foam for tight fit
- minimum display



rrc-rrbuc1

€ 99,-

rrbuc1: small utility case - 362 x 312 x 130mm (inner dimensions)

- outer dimensions: 380 x 330 x 150mm
- inner dimensions: 362 x 312 x 130mm
- small suitcase-style utility case
- butterfly catch & handle on the front
- hinges on the back





rrc-rrbuc2

€ 129,-

rrbuc2: small utility case - 567 x 342 x 132mm (inner dimensions)

- outer dimensions: 585 x 360 x 152mm
- inner dimensions: 567 x 342 x 132mm
- small suitcase-style utility case
- 2 butterfly catches & handle on the front
- hinges on the back



rrc-rrbuc3

€ 159,-

rrbuc3: small utility case - 597 x 475 x 200mm (inner dimensions)

- outer dimensions: 615 x 493 x 220mm
- inner dimensions: 597 x 475 x 200mm
- small suitcase-style utility case
- 2 butterfly catches & handle on the front
- hinges on the back



rrc-rrbuc4

€ 139,-

rrbuc4: small utility case - 462 x 312 x 180mm (inner dimensions)

- outer dimensions: 480 x 330 x 200mm
- inner dimensions: 462 x 312 x 180mm
- small suitcase-style utility case
- 5mm plywood
- 2 butterfly catches & handle on the front
- hinges on the back

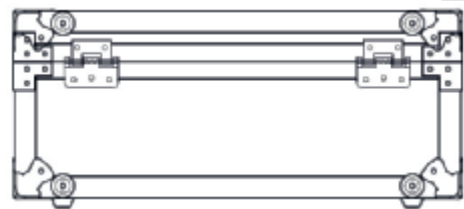

BEST VALUE

rrc-rrbuc5

€ 159,-

rrbuc5: small utility case - 567 x 342 x 230mm (inner dimensions)

- outer dimensions: 585 x 360 x 250 mm
- inner dimensions: 567 x 342 x 230 mm
- small suitcase-style utility case
- 5mm plywood
- 2 butterfly catches & handle on the front
- hinges on the back

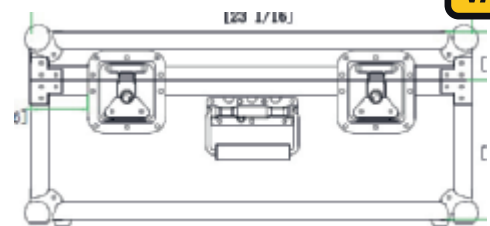

BEST VALUE

rrc-rrbuc6

€ 219,-

rrbuc6: utility case - 632 x 532 x 300mm (inner dimensions)

- outer dimensions: 650 x 550 x 320 mm
- inner dimensions: 632 x 532 x 300 mm
- suitcase-style utility case
- 5mm plywood
- 2 butterfly catches & handle on the front
- hinges on the back

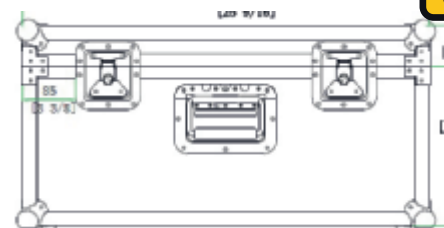

BEST VALUE



rrc-rrfc1

€ 139,-

foam case - 410 x 277 x 146mm (inner dimensions) with Pick-&-Fit

- small suitcase-style utility case with pick-& fit foam
- 2 butterfly catches & handle on the front
- hinges on the back
- outer dimensions: 442 x 309 x 181mm
- inner dimensions: 410 x 277 x 146mm



rrc-rrfc2

€ 229,-

foam case - 561 x 355 x 220mm (inner dimensions) with Pick-&-Fit

- small suitcase-style utility case with pick-& fit foam
- 2 butterfly catches & handle on the front
- hinges on the back
- outer dimensions: 593 x 387 x 278mm
- inner dimensions: 561 x 355 x 220mm

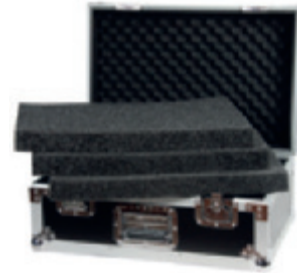

rrc-rrfc3

€ 399,-

foam case - 770 x 370 x 374mm (inner dimensions) with Pick-&-Fit

- small suitcase-style utility case with pick-& fit foam
- 2 butterfly catches on the front
- handles on left, right and front side
- hinges on the back
- outer dimensions: 802 x 402 x 432mm
- inner dimensions: 770 x 370 x 374mm

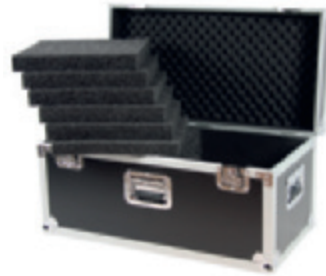

rrc-rrfc4

€ 179,-

foam case - 410 x 336 x 245mm (inner dimensions) with Pick-&-Fit

- small suitcase-style utility case with pick-& fit foam (5 pieces of 35mm)
- 2 butterfly catches on the front
- handle on the front side
- hinges on the back
- outer dimensions: 442 x 369 x 278 mm
- inner dimensions: 410 x 336 x 245 mm

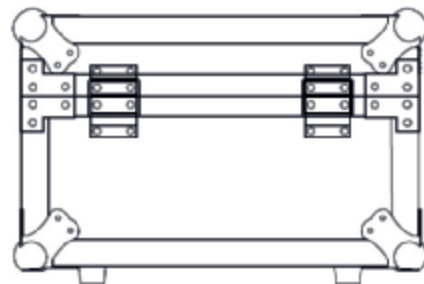

rrc-rrfc5

€ 209,-

foam case - 410 x 367 x 245mm (inner dimensions) with Pick-&-Fit

- small suitcase-style utility case with pick-& fit foam (5 pieces of 35mm)
- 2 butterfly catches on the front
- handle on the front side
- hinges on the back
- outer dimensions: 442 x 400 x 278 mm
- inner dimensions: 410 x 367 x 245 mm

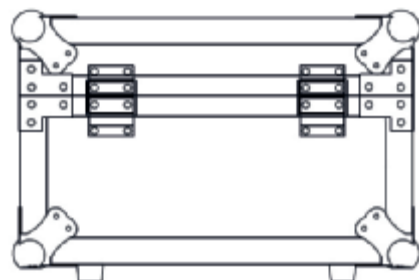

**rrc-rrfc6****€ 339,-****foam case - 561 x 468 x 340mm (inner dimensions) with Pick-&-Fit**

- small suitcase-style utility case with pick-& fit foam (5x 50mm + 1x 40mm)
- 2 butterfly catches on the front
- handle on the left, right & front side
- hinges on the back
- outer dimensions: 593 x 500 x 378 mm
- inner dimensions: 561 x 468 x 340 mm

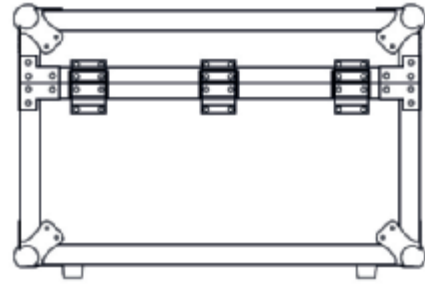
**rrc-rrpc1****€ 159,-****pallet case - 582 x 377 x 318 mm (outside dimensions)**

- utility case with dimensions suited for european pallets
- 2x butterfly catches on the front
- handles on left, right & front side
- hinges on the back
- outer dimensions: 582 x 377 x 318 mm
- inside dimensions: 550 x 345 x 260 mm

**rrc-rrpc2****€ 199,-****pallet case - 782 x 384 x 446 mm (outside dimensions)**

- utility case with dimensions suited for european pallets
- 2x butterfly catches on the front
- handles on left & right side
- hinges on the back
- outer dimensions: 782 x 384 x 446 mm
- inside dimensions: 750 x 352 x 388 mm

**rrc-rrpc3****€ 199,-****pallet case - 582 x 382 x 448 mm (outside dimensions)**

- utility case with dimensions suited for european pallets
- 2x butterfly catches on the front
- handles on left & right side
- hinges on the back
- outer dimensions: 582 x 382 x 448 mm
- inside dimensions: 550 x 350 x 390 mm

**rrc-rrpc4****€ 249,-****pallet case - 1187 x 382 x 443 mm (outside dimensions)**

- utility case with dimensions suited for european pallets
- 2x butterfly catches on the front
- handles on left & right side
- hinges on the back
- outer dimensions: 1187 x 382 x 443 mm
- inside dimensions: 1155 x 350 x 385 mm



**rrc-rrpc5****€ 239,-****pallet case - 782 x 587 x 443 mm (outside dimensions)**

- utility case with dimensions suited for european pallets
- 2x butterfly catches on the front
- handles on left & right side
- hinges on the back
- outer dimensions: 782 x 587 x 443 mm
- inside dimensions: 750 x 555 x 385 mm

**rrc-rrdrc****€ 129,-****digital recording studio utility case with pick-&-fit foam**

- outside dimensions: 618 x 455 x 242 mm
- inner dimensions: 558 x 420 x 174 mm
- Pick & Fit foam for custom fitting of your gear
- lid lined with egg foam
- handle on the front
- butterfly catches on the front side (2 total)

**rrc-rruc****€ 79,-****Small utility case with adjustable pick & fit foam**

- outer dimensions: 325 x 315 x 140 mm
- inner dimensions: 300 x 265 x 93 mm
- small suitcase-style utility case
- butterfly catch & handle on the front
- hinges on the back

**rrc-rrluc****€ 109,-****large adjustable utility case with Pick & Fit foam, fits the Pioneer ToraiZSP-16**

- outside dimension: 585 x 382 x 166 mm
- fits devices up to 53cm long, 31cm wide, and 11cm high
- fully adjustable with Pick & Fit foam
- handle on front side (1 total)
- butterfly catches on front side (2 total) with take-apart hinges

**rrc-RRVLUC****€ 89,-****Value right utility case with Pick&Fit foam**

- Value right utility case with Pick&Fit foam
- fits products measuring up to 22" (55,8 cm) X 13.25" (33,6 cm) X 4.5" (11,4 cm)
- fits akai MPC1000



**rrc-rrwireless****€ 99,-**

case with pick & fit foam for wireless mics - fits most models

**rrc-rrvwireless****€ 89,-**

Value right case with pick&fit foam for wireless mic



5mm
lightweight
plywood

rrc-rrut1**€ 469,-**

Universal Utility Trunk 1135x748x787 mm with adjustable compartments and drawers

- Utility Trunk case
- 1135x748x787 mm (outer dimensions)
- 1092x702mm inner dimensions. Inner height base : 496mm Inner height cover: 106mm
- 2 butterfly catches on front
- 2 Carry handle on front, back, left and right side (8 in total)

**rrc-rrut1e****€ 389,-**

Universal Utility Trunk 749x1137x762mm with caster board

- Utility Trunk case
- 1135x748x787 mm (outer dimensions)
- 1092x702mm inner dimensions. Inner height base : 496mm Inner height cover: 106mm
- 2 butterfly catches on front
- 2 Carry handle on front, back, left and right side (8 in total)

**rrc-rre1ut****€ 299,-**

Euro Trunk Pack Utility Trunk - 780 x 580 x 410 mm (outer dimensions)

- large trunk (euro trunk pack)
- hinged lid with protection straps
- outer dimensions: 780 x 580 x 410 mm
- multiple handles on left and right side (4 total)
- butterfly catches on front side (2 total)



**rrc-rre1utc****€ 329,-****Euro Trunk Pack Utility Trunk - 780 x 580 x 410 mm (outer dimensions) w/ wheels**

- large trunk (euro trunk pack)
- hinged lid with protection straps
- outer dimensions: 780 x 580 x 410 mm
- multiple handles on left and right side (4 total)
- butterfly catches on front side (2 total)
- big sturdy wheels on the bottom

**rrc-rre2ut****€ 209,-****Euro Trunk Pack Utility Trunk - 780 x 380 x 410 mm (outer dimensions)**

- large trunk (euro trunk pack)
- hinged lid with protection straps
- outer dimensions: 780 x 380 x 410 mm
- handles on left and right side (2 total)
- butterfly catches on front side (2 total)

**rrc-rre3ut****€ 199,-****Euro Trunk Pack Utility Trunk - 580 x 380 x 419 mm (outer dimensions)**

- large trunk (euro trunk pack)
- hinged lid with protection straps
- outer dimensions: 580 x 380 x 419 mm
- handles on left and right side (2 total)
- butterfly catches on front side (2 total)

**rrc-rre4ut****€ 179,-****Euro Trunk Pack Utility Trunk - 580 x 380 x 280 mm (outer dimensions)**

- large trunk (euro trunk pack)
- hinged lid with protection straps
- outer dimensions: 580 x 380 x 280 mm
- handles on left and right side (2 total)
- butterfly catches on front side (2 total)

**rrc-rre5utw****€ 349,-****utility trunk for stands - 1180 x 380 x 335 mm (outer dimensions) with wheels**

- large trunk (euro trunk pack)
- hinged lid with protection straps
- outer dimensions: 1180 x 430 x 335 mm (+ 128 mm height wheels)
- handles on left and right side (2 total)
- butterfly catches on front side (2 total)
- big sturdy wheels



**rrc-rrehut1****€ 239,-****Euro universal utility trunk - 567*567*627 (H), with 3 divisions + cable tray**

- Euro universal utility trunk - 567*567*627 (H), with 3 divisions + cable tray
- half of the RREUT1
- hinged lid with protection straps
- In the bottom 3 divisions + cable tray, no wheels
- multiple handles on left and right side (4 total)

**rrc-rrehut1e****€ 199,-****Euro universal utility trunk (half of RREUT1E) - 567*567*627 (H) outside empty**

- Euro universal utility trunk (half of RREUT1E) - 567*567*627 (H) outside empty
- half of the RREUT1E
- hinged lid with protection straps
- no wheels
- multiple handles on left and right side (4 total)
- butterfly catches on front side

**rrc-rrehut1ec****€ 249,-****Euro universal utility trunk with wheels - 567*567*627 (H) outside empty**

- Euro universal utility trunk with wheels - 567*567*627 (H) outside empty
- half of the RREUT1E
- hinged lid with protection straps
- outer dimensions: 567*567*527 (H)
- multiple handles on left and right side (4 total)
- butterfly catches on front side (2 total)
- big sturdy wheels on the bottom

**rrc-rreut1e****€ 379,-****Euro universal utility trunk - 1175 x 590 x 791 mm (outside) with wheels**

- euro utility trunk
- hinged lid with protection straps
- outer dimensions: 1175 x 590 x 791 mm
- multiple handles on front, left, right and back side (8 total)
- butterfly catches on front side (2 total)
- big sturdy wheels on the bottom

**rrc-rrcablecasew****€ 549,-****Cable case - 800 x 1200 x 800 mm with wheels and 2 dividers**

- large trunk for cables
- hinged lid with protection straps
- freely divide into 3 compartments
- outer dimensions: 1200 x 800 x 800 mm
- handles on left and right side (4 total)
- butterfly catches on front side (2 total)
- big sturdy wheels



**rrc-rrcablecasemaxiw****€ 499,-****Large Cable case - 1207 x 607 x 755 mm with wheels and 3 dividers**

- Large trunk for cables
- hinged lid with protection straps
- freely divide into 4 compartments
- outer dimensions: 1207 x 607 x 755 mm
- handles on left & right sides (4 total)
- butterfly catches on front side (2 total)
- big sturdy wheels

**rrc-rrcablecasemedw****€ 449,-****Cable case - 590 x 1175 x 791 (outside) mm with wheels**

- large trunk for cables
- hinged lid with protection straps
- freely divide into 3 compartments
- outer dimensions: 1175 x 590 x 791 mm (with wheels)
- handles on all 4 sides (8 total)
- butterfly catches on front side (2 total)

**rrc-rrcablecaseminiw****€ 349,-****Small Cable case - 498 x 780 x 578 mm with wheels and 2 dividers**

- small trunk for cables
- hinged lid with protection straps
- freely divide into 3 compartments
- outer dimensions: 498 x 780 x 578 mm
- handles on all 4 sides (8 total)
- butterfly catches on front side (2 total)
- big sturdy wheels



**rrc-rrcf4****€ 69,-****19" rackmountable, tiltable cooling panel w/ 4 fans for all rack systems**

- 19" 2 Unit metal panel (incl. mounting hardware)
- adjustable mounting angles
- 4 cool tone fans
- outer dimensions: 480 x 89 x 29 mm

**rrc-rrlapt1****€ 77,-****universal adjustable laptop stand, fits all RR dj coffins and most mixer cases**

- universal adjustable Laptop / CDplayer stand
- fits all RoadReady dj coffins and most mixer cases
- attaches to de side of flightcase
- platform fits laptop up to 17" (407 x 288 mm)
- tiltable
- incl. mouse extention platform RRMOUSE

**rrc-rrlwing****€ 59,-****folding laptop wing - attaches to any coffin, mixer case**

- folding laptop wing
- outside dimensions: 432 x 432 x 51 mm
- attaches to the side of any coffin, mixer case

**rrc-rrlr19****€ 69,-****19" rackmountable folding laptop tray - perfect add on for any RR slanted rack**

- 19" rackmountable folding laptop tray
- perfect add on for any RoadReady slanted rack
- Fits all Road Ready 19" Coffins, Slant Racks, 19" Rackmount Mixer cases and Lighting Controller cases
- Unique rubberized surface for laptop grip
- Folds

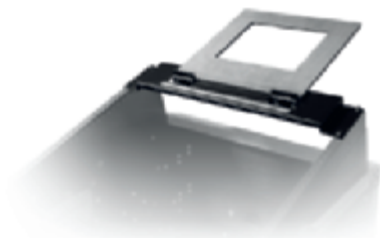
**rrc-rrdjstand****€ 165,-****folding DJ coffin stand with integrated shelf**

- ultra portable table, light and sturdy
- 3-way foldable plate 915mm height
- place DJ coffin on top
- lockable, with handles
- integrated shelf on 467mm height



**rrc-rrstandt****€ 209,-****compact, folding universal table / stand - 91,4 cm high**

- ultra portable stand / table for universal use, light and sturdy
- 4-way foldable surface plate: 1220 x 610 mm
- lockable, lightweight collapsible riser: 914mm height
- easily carried on your shoulder with the included shoulder strap
- riser

**rrc-rrstandt1****€ 189,-****compact, folding universal table / stand - 76,2 cm high**

- ultra portable stand / table for universal use, light and sturdy
- 4-way foldable surface plate: 1220 x 610 mm
- lockable, lightweight collapsible riser: 762mm height
- easily carried on your shoulder with the included shoulder strap
- riser

**rrc-rr21stand****€ 116,-****compact 21" high folding stand for slant racks and dj work stations**

- ultra portable table, light and sturdy
- 4-way foldable surface plate: 446 x 448 mm
- lockable, lightweight collapsible riser: 523mm height
- easily carried on your shoulder with the included shoulder strap
- Supports up to 1500kg!





THE INTELLISTAGE STAGES CAN BE ASSEMBLED VERY QUICKLY AND EASILY AND CAN HOLD A WEIGHT OF UP TO 900KG/M².

The platforms are equipped with cable-guides and metal corners . Multiple risers can be placed on top of one another for extra height. The stages are endlessly expandable in a great variety of formations to suit your needs.

The platforms are covered with a layer of Tuff-Coat. Tuff-Coat is a kind of flexible water-based paint with a lot of advantages: environment friendly, very durable, protects against mechanical damage, fireproof,... Tuffcoat offers a great balance between firmness, impact resistance, flexibility, anti scratch and hardness.



This is just a small selection from the huge range...

Check out intellistage.com for more info, videos,... or assemble your own stage with the stage builder!



Tuff-Coat Finish Rectangle Platforms

1. Platforms:

The building-blocks of your stage. Covered in a scratch-proof Tuffcoat top layer and a load capacity of up to 900kg/m². Compatible with guard rails.



code	description	price
itl-isepe2x1ts	2mx1m Tuff-Coat Finished Platform 1pc - Weight: 29,1 kg - Dimensions: 205 * 105 * 6 cm	€ 359.51,-
itl-isepe1x1ts	1mx1m Tuff-Coat Finished Platform (single pack) - Weight: 16,2 kg - Dimensions: 105 * 105 * 6,5 cm	€ 187.14,-

Risers for 2m x 1m Platforms

With the aluminum risers you can get your stage to the desired height. These elements are very light and can be folded very compact. Furthermore, multiple risers can be stacked in different combinations.



code	description	price
itl-ise2x1x60	Riser for 2mx1m Platform 60cm High - Weight: 9,3 kg - Dimensions: 80,7 * 29,5 * 49,5 cm	€ 204.51,-
itl-ise2x1x30	Riser for 2mx1m Platform 30cm High - Weight: 20 kg - Dimensions: 60,5 * 29,5 * 47,5 cm	€ 155.26,-
itl-ise2x1x40	Riser for 2mx1m Platform 40cm High - Weight: 19,5 kg - Dimensions: 64,8 * 14 * 22 cm	€ 174.96,-
itl-ise2x1x20	Riser for 2mx1m Platform 20cm High - Weight: 18 kg - Dimensions: 55,5 * 29,5 * 46,5 cm	€ 153.96,-
itl-ise2x1x80	80 cm High Riser for 2 m x 1 m Platform - Weight: kg - Dimensions: * * cm	€ 234.06,-
itl-ise2x1x90	90 cm High Riser for 2 m x 1 m Platform - Weight: kg - Dimensions: * * cm	€ 250.13,-

Risers for 1m x 1m Platforms

With the aluminum risers you can get your stage to the desired height. These elements are very light and can be folded very compact. Furthermore, multiple risers can be stacked in different combinations.



code	description	price
itl-ise1x1x60	Riser for 1mx1m Platform 60cm High - Weight: 3,2 kg - Dimensions: 79,5 * 14 * 14 cm	€ 124.42,-
itl-ise1x1x40	Riser for 1mx1m Platform 40cm High - Weight: 2,5 kg - Dimensions: 65,1 * 14 * 14 cm	€ 113.27,-
itl-ise1x1x30	Riser for 1mx1m Platform 30cm High - Weight: 2,4 kg - Dimensions: 59,5 * 14 * 14 cm	€ 106.01,-
itl-ise1x1x20	Riser for 1mx1m Platform 20cm High - Weight: 2,1 kg - Dimensions: 54,5 * 14 * 14 cm	€ 103.42,-
itl-ise1x1x80	Riser for 1mx1m Platform 80cm High - Weight: kg - Dimensions: 94,5 * 14 * 14 cm	€ 142.82,-
itl-ise1x1x90	90 cm High Riser for 2 m x 1 m Platform - Weight: kg - Dimensions: * * cm	€ 153.96,-



Guard Rails

Banisters for extra safety on stage.



code	description	price
itl-isestepgrpd	2-pack of step guard rail panels w/mounting hardware - Weight: 6 kg - Dimensions: 38 * 12 * 117,5 cm	€ 117.16,-
itl-ise1x1grpd	2pack Guard Rail panel for 1x1m platform w hardware - Weight: 13,5 kg - Dimensions: 102,5 * 12 * 117,5 cm	€ 224.21,-

Guard Rails Accessories



code	description	price
itl-is2cmb	2 pack of guard rail panel corner mounting bracket - Weight: 0,2 kg - Dimensions: 10 * 10 * 5 cm	€ 11.15,-
itl-is10ms	10 pack of guard rail mounting screws - Weight: 0,2 kg - Dimensions: 10 * 10 * 5 cm	€ 4.92,-
itl-is2smb	2 pack of guard rail panel side mounting bracket - Weight: 0,1 kg - Dimensions: 10 * 10 * 5 cm	€ 9.85,-

General stage accessories and Parts



itl-is10rf



itl-isstcup



itl-issj



itl-isrk

code	description	price
itl-is10rf	10 Pack of self adhesive rubber feet for risers - Weight: 2,5 kg - Dimensions: 25 * 12 * 17 cm	€ 3.11,-
itl-isstcup	STACKING CUP FOR INTELLISTAGE RISERS (25 PACK) - Weight: 2 kg - Dimensions: 29 * 23 * 15 cm	€ 39.4,-
itl-issj	2pack connecting hardware - Weight: 16,8 kg - Dimensions: 32,5 * 25 * 30 cm	€ 16.85,-
itl-isrk	Replacement Parts Kit - Weight: kg - Dimensions: * * cm	€ 5.18,-



THE PROFLEX STAGES ARE MODULAR AND CAN BE ASSEMBLED VERY QUICKLY AND EASILY.

They are adjustable in height thanks to their telescopic legs and can hold a weight of up to 750kg/m². Made from light-weight but very sturdy aluminum and available in different finishes.

The individually height-adjustable legs make these stages suited for every type of surface (slopes, hills, sidewalks...) with rubber feet for extra stability. Made in Europe and fully TUV-certified.

This is just a small selection from the huge range... Check out proflexstaging.com for more info, videos,... Or assemble your own stage with the stage builder!

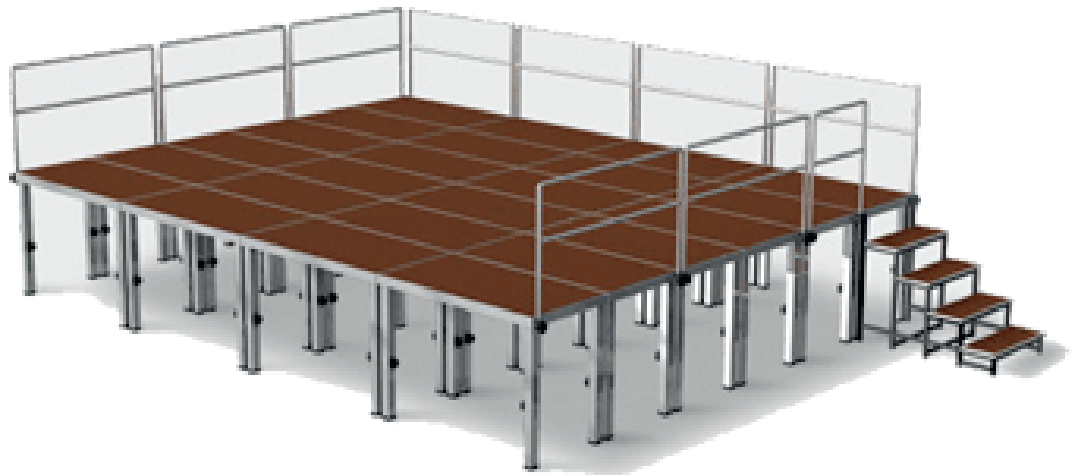

Stage Panels

1m X 1m Industrial Finish Stage Panel, Black - single pack

Leg Brace for 2 x1 m Panels - for 2 m long sides of panels - single

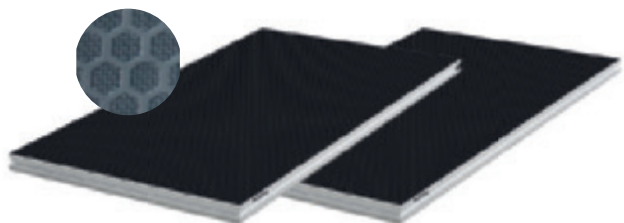

code	description	price
pfl-pfep1x1ib	1m X 1m Industrial Finish Stage Panel, Black - single pack	€ 299,-
pfl-pfep2x1ib	2m X 1m Industrial Finish Stage Panel, Black - single pack	€ 399,-



Special Orders Panels

1mx 0.5m Industrial Finish Stage Panel, Black - single pack

0

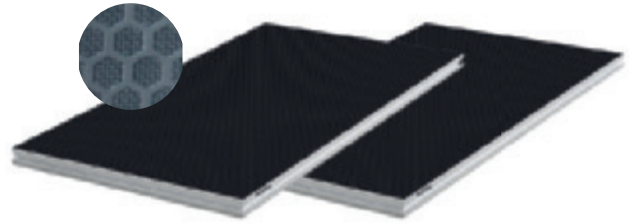

code	description	price
pfl-pfe1x0.5ib	1mx 0.5m Industrial Finish Stage Panel, Black - single pack	€ 219,-
pfl-pfep2x0.5ib	2m X 0.5m Industrial Finish Stage Panel, Black - single pack	€ 369,-

Stage Legs

Telescopic Leg Adjustable from 40 to 60 cm - four pack

Telescopic Leg Adjustable from 40 to 60 cm - four pack



code	description	price
pfl-pfe4tl1	Telescopic Leg Adjustable from 40 to 60 cm - four pack	€ 148.07,-
pfl-pfe4tl2	Telescopic Leg Adjustable from 50 to 80 cm - four pack	€ 163.2,-
pfl-pfe4tl3	Telescopic Leg Adjustable from 60 to 100 cm - four pack	€ 178.32,-
pfl-pfe4tl4	Telescopic Leg Adjustable from 80 to 140 cm - four pack	€ 214.94,-
pfl-pfe4tl5	Telescopic Leg Adjustable from 100 to 180 cm- four pack	€ 251.57,-
pfl-pfe4tl6	Telescopic Leg Adjustable from 120 to 220cm - four pack	€ 288.98,-
pfl-pfe4fl20	Four pack of Fixed Legs for 20 cm high Stage	€ 34.23,-
pfl-pfe4fl40	Four pack of Fixed Legs for 40 cm high Stage	€ 49.36,-
pfl-pfe4fl60	Four pack of Fixed Legs for 60 cm high Stage	€ 63.69,-
pfl-pfefl80	Fixed Leg for 80 cm high Stage	€ 19.9,-
pfl-pfefl100	Fixed Leg for 100 cm high Stage	€ 23.09,-
pfl-pfefl120	Fixed Leg for 120 cm high Stage	€ 27.07,-
pfl-pfefl140	Fixed Leg for 140 cm high Stage	€ 30.25,-
pfl-pfefl160	Fixed Leg for 160 cm high Stage	€ 34.23,-
pfl-pfefl180	Fixed Leg for 180 cm high Stage	€ 37.42,-
pfl-pfefl200	Fixed Leg for 200 cm high Stage	€ 40.6,-
pfl-pfefl40w	Fixed Leg for 40 cm high Stage with Wheels	€ 78.02,-



Guard Rails

1m long Stage Guardrail with Mounting Hardware - single

1m long Stage Guardrail with Mounting Hardware - single



code	description	price
pfl-pfegr1	1m long Stage Guardrail with Mounting Hardware - single	€ 152.05,-
pfl-pfegr2	2m long Stage Guardrail with Mounting Hardware - single	€ 174.34,-

Stairs assemblies

Two Steps Adjustable Stairs for Stages 15 3/4" to 23 1/2"

1m long Stage Guardrail - dual pack with Mounting Hardware



code	description	price
pfl-pfastr2	Two Steps Adjustable Stairs for Stages 15 3/4" to 23 1/2"	€ 482.8,-
pfl-pfastr4	Four Steps Adjustable Stairs for Stages 23 3/4" to 39 1/4"	€ 546.23,-
pfl-pfastr5	Five Steps Adjustable Stairs for Stages 31 1/2" to 55"	€ 616.71,-
pfl-pfastr7	Seven Steps Adjustable Stairs for Stages 39 1/2" to 70 3/4"	€ 648.43,-
pfl-pfestr2	Fixed Steps; first 20 cm high	€ 148.01,-
pfl-pfestr4	Fixed Steps; first 20 cm high and second 40 cm high.	€ 264.3,-
pfl-pfestr6	Fixed Steps; third 60 cm high	€ 165.63,-
pfl-pfestr8	Fixed Steps; fourth 80 cm high	€ 183.25,-

Guardrails for stairs

Universal, Adjustable Stair Handrail. Fits all Adjustable Stairs - dual pack, Mounting hardware included

Five Steps Adjustable Stairs for Stages 31 1/2" to 55"

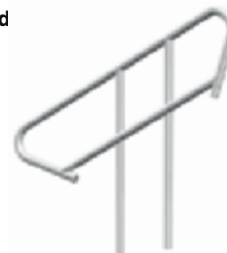

code	description	price
pfl-pf2astgr	Universal, Adjustable Stair Handrail. Fits all Adjustable Stairs - dual pack, Mounting hardware included	€ 288.98,-
pfl-pfmstgr	Modular Stairs Handrail for Fixed Steps - dual pack. Mounting Hardware included	€ 288.98,-
pfl-pf2gr2	2 Step Stairs Handrail - dual pack - Mounting Hardware included	€ 304.11,-
pfl-pf2gr3	3 Step Stairs Handrail - dual pack - Mounting Hardware included	€ 347.89,-



Storage and transportation system

Guardrails Trolley - stores up to 24 2 m Guardrails

Fixed Steps; third 60 cm high

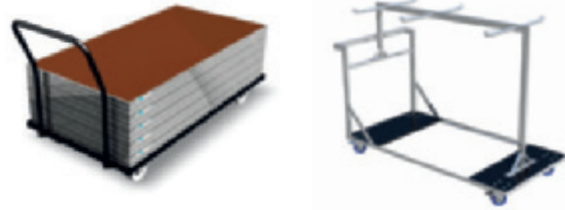

code	description	price
pfl-pfegrtr	Guardrails Trolley - stores up to 24 2 m Guardrails	€ 807.01,-
pfl-pfeptr	Platform Trolley - stores up to 15 pcs. of 2 X 1 m Panels	€ 525.08,-
pfl-pfe1grtr	Guardrails Trolley - stores up to 22 1 m Guardrails	€ 567.71,-
pfl-pfe1ptr	Platform Trolley - stores up to 15 pcs. of 1 X 1 m Panels	€ 428.46,-

Accessories



code	description	price
pfl-pfai	Assembly insert - single pack	€ 7.05,-
pfl-pf10ai	Assembly insert - ten pack	€ 70.48,-
pfl-pfdai	Double assembly insert - single pack	€ 8.81,-
pfl-pf10dai	Double assembly insert - ten pack	€ 88.1,-
pfl-pfsli	Self-Leveling Panel Insert - single	€ 3.52,-
pfl-pf10sli	Self-Leveling Panel Insert - ten pack	€ 35.24,-
pfl-pfpsc	Panel to Panel Stage Clamp - single	€ 8.81,-
pfl-pf2psc	Panel to Panel Stage Clamp - dual pack	€ 17.62,-
pfl-pf6psc	Panel to Panel Stage Clamp - six pack	€ 52.86,-
pfl-pfsc	Panel to Panel Stage Connector - single	€ 8.81,-
pfl-pf10sc	Panel to Panel Stage Connector - 10 pack	€ 87.63,-
pfl-pfla2	Leg Adaptor for two Panels - single	€ 35.24,-
pfl-pf2la2	Leg Adaptor for two Panels - dual pack	€ 74.04,-
pfl-pfla4	Leg Adaptor for four Panels - single	€ 59.91,-
pfl-pfelb1	Leg Brace for 2 x1 m Panels - for 1 m long sides of panel - single	€ 52.54,-
pfl-pfelb2	Leg Brace for 2 x1 m Panels - for 2 m long sides of panels - single	€ 71.65,-
pfl-pfe2lb1	Leg Brace for 2 x1 m Panels - dual pack - for 1 m long sides of panel with mounting hardware	€ 105.09,-
pfl-pfe2lb2	Leg Brace for 2 x1 m Panels - dual pack - for 2 m long sides of panels with mounting hardware	€ 142.5,-
pfl-pfbc	Leg Clamp for attachment of Leg Brace to Leg - single pack	€ 11.94,-
pfl-pf2bc	Leg Clamp for attachment of Leg Brace to Leg - dual pack	€ 23.09,-
pfl-pfgrcl	Guardrail Assembly Clamp - single	€ 31.72,-
pfl-pf2grcl	Guardrail assembly clamp - two pack	€ 63.43,-
pfl-pf4grcl	Guardrail Assembly Clamps - four pack	€ 126.87,-
pfl-pfdslc	Dual Stage Leg Clamp, necessary for all Stages higher then 23 1/2"	€ 11.94,-
pfl-pfqslc	Quad Stage Leg Clamp, necessary for all Stages higher then 23 1/2"	€ 25.47,-
pfl-pf4ra	Platform Adapter to Accommodate Round Legs - 4 Adapters per pack - 1 masterpack per platform needed if using round legs	€ 37.42,-
pfl-pfscclip5	Skirt Clips - 5 pack	€ 13.93,-
pfl-pfecsc	1 m. long Chair Stop with mouting hardware	€ 24.68,-



THE ALL TERRAIN STAGES ARE MODULAR AND CAN BE ASSEMBLED VERY QUICKLY AND EASILY.

They are adjustable in height thanks to their sturdy telescopic legs and can hold a weight of up to 750kg/m². Made from lightweight but very sturdy aluminum and available in different finishes.

The individually height-adjustable legs make these stages suited for every type of surface (slopes, hills, sidewalks...)

The height adjustable legs can be fitted with an extension pole to make them even higher. Made in Europe and fully TUV-certified.

This is just a small selection from the huge range... Check out intellistage.com for more info, videos,... or assemble your own stage with the stage builder!

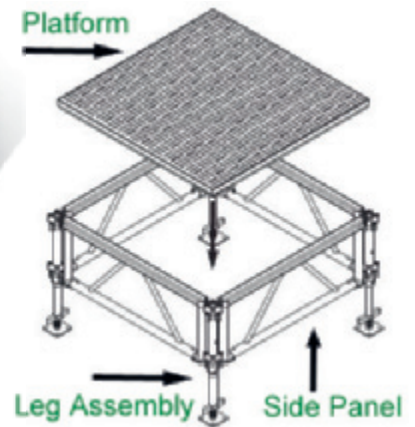
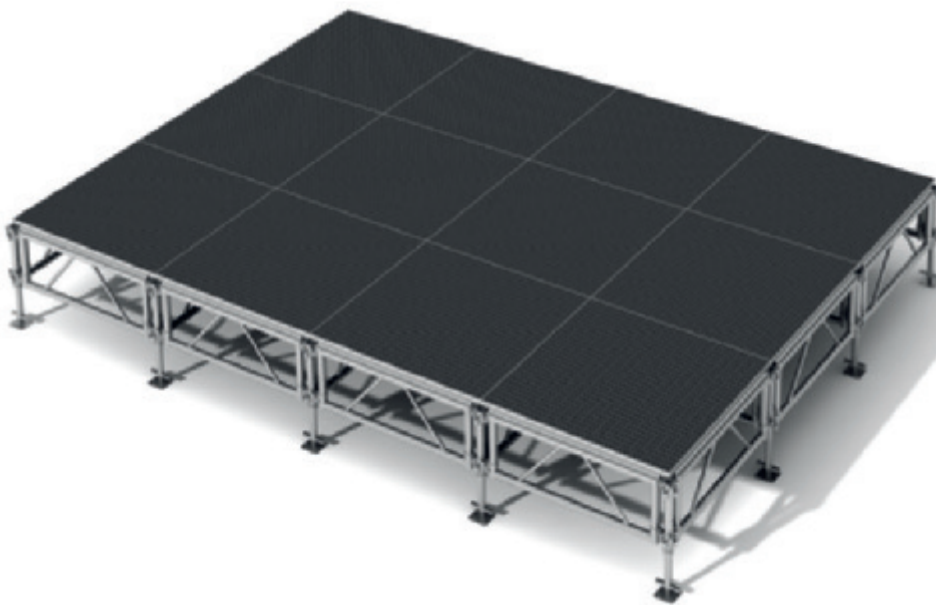

All Terrain Staging Platforms

4 ft x 4 ft weather resistant stage platform - industrial finish (single pack)

panels are 1m22 x 1m22 - weather resistant



ats-at4pws



ats-at4prs



code	description	price
ats-at4prs	4 ft x 4 ft weather resistant stage platform - industrial finish (single pack)	€ 257.64,-
ats-at4pws	4 ft x 4 ft weather proof aluminum stage platform (single pack)	€ 399.69,-
ats-at4sps	4ft long aluminum stage side panel (single pack)	€ 103.68,-



All Terrain Staging Legs

Five steps, universal weather proof aluminum stair assembly for All Terrain stag

weight: 50 kg - L*W*H : 182*39*107 cm

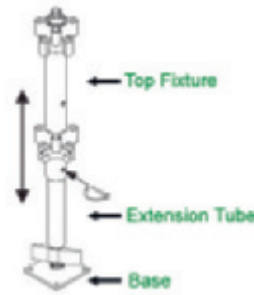

ats-atlaed v2



ats-atlb

code	description	price
ats-atlaedv2	Adjustable stage leg assembly for 24, 32, 40 inch; set of 2 pieces	€ 165,89,-
ats-atled	Long stage leg extensions for 48" & 120 cm stage (2pcs per master pack)	€ 64.28,-
ats-atlb	Adjustable stage leg base (single pack)	€ 18.4,-

US - All Terrain Staging Guard Rails

Side guard rail for 4 ft x 4ft stage platforms (single pack)

weight: 6,5 kg - L*W*H : 151*9*122 cm



ats-at4grs



ats-atmgr

code	description	price
ats-at4grs	Side guard rail for 4 ft x 4ft stage platforms (single pack)	€ 143.6,-
ats-atmgr	Corner guard rail adapter for stage system (single pack)	€ 33.96,-

All Terrain Staging Stair Components

4ft long aluminum stage side panel (single pack)

weight: 4,5 kg - L*W*H : 118*45,5*7 cm



ats-at4stw3



ats-at4stw5

code	description	price
ats-at4st3v2	Three steps, universal stair assembly for All Terrain stage - for 24 & 32 inch	€ 492,74,-
ats-at4stw3	Three steps, universal weather proof aluminum stair assembly for All Terrain sta	€ 664.33,-
ats-at4st5v2	Three steps, universal stair assembly for All Terrain stage - for 24 & 32 inch h	€ 693,10,-
ats-at4stw5	Five steps, universal weather proof aluminum stair assembly for All Terrain stag	€ 983.15,-



Universal Guard Rails for Stair Packages

Universal guard rail assembly for 3 step stairs with mounting hardware (2pcs per

weight: 10 kg - L*W*H : 143*18*15 cm



ats-atst3grd



ats-atst5grd



ats-atesat

code	description	price
ats-atst3grd	Universal guard rail assembly for 3 step stairs with mounting hardware (2pcs per	€ 353.81,-
ats-atst5grd	Universal guard rail assembly for 5 step stairs with mounting hardware (2pcs per	€ 370.66,-
ats-atesat	Stage alignment tool and level for 1 m x 1 m stages	€ 33.7,-

US - All Terrain Stage Alignment Tool

Stage alignment tool and level for 4 ft x 4 ft stages

weight: kg - L*W*H: ** cm



ats-at4sat

code	description	price
ats-at4sat	Stage alignment tool and level for 4 ft x 4 ft stages	€ 34.21,-

All Terrain Staging Parts & Accessories

Rubber non-slip thick mats for indoor use (4 pack)

weight: 1,8 kg - L*W*H : 49*19*11 cm



ats-atlbrm4



ats-atlbrm10



ats-atlbat4



ats-atlbat16



ats-atlbwd

code	description	price
ats-atlbrm4	Rubber non-slip thick mats for indoor use (4 pack)	€ 14,-
ats-atlbrm10	Rubber non-slip mats for indoor use (10 pack)	€ 12.7,-
ats-atlbat4	All Terrain base spike adapters for outdoor use (4 pack)	€ 8.29,-
ats-atlbat16	All Terrain base spike adapters for outdoor use (16 pack)	€ 32.92,-
ats-atlbwd	Adjustable wedges for stage leg's installation on slopes (2pcs per master pack)	€ 30.59,-



STAGING 101 SLIM FOLDING HEIGHT ADJUSTABLE STAGE

The folding stages from the staging 101 are the most easy to set up stages ever. Everyone can set up this stage in a fast and easy way. The system is very simple: one stage is 4*8 ft or 1m22 to 2m44. It is folded vertically. Just unfold the height adjustable folding legs (20-40 or 60 cm), and put the stage where you want.

- Unique, Revolutionary Slim, Frameless wheel base design for compact storage and fast easy set up.
- Flat pack shipping saves on shipping costs compared to competitors models that ship standing up-right.
- Height adjustable to 8", 16" or 24" (20cm, 40cm, or 60cm) high
- Simple Mobile, Folding Stage design based on the concept of a folding table
- Modular Platforms come in 4' x 8' or 2m x 1m sizes and connect easily together to form custom size stages.
- Fast easy set-up by 1 person.
- Perfect for schools, churches, hotels, exhibition halls and many other applications.
- For use mostly indoors and should be installed on a flat surface.
- 10 Year warranty
- Available in 2 surface finishes
- Weight rated at: 750 KG / SQ M (153 LBS /SQ FT).

1.



2.



3.



4.



5.



Simple folding table like design

Adjusts to 3 heights!

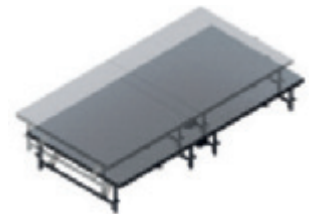

To set up at 16" (40cm) and 24" (60cm) high, simply unfold the height adjustable folding legs



When setting up stage at 8" (20cm) high, use the screw in legs that are stored in the frame of the stage

10 YEAR WARRANTY!

4' x 8' or 2m x 1m Tri-Height Mobile Folding Stages w/ Wheels

EAST ONE PERSON SET UP!
REVOLUTIONARY SLIM, FRAMELESS WHEEL BASE DESIGN FOR EASY MANEUVERABILITY AND COMPACT STORAGE

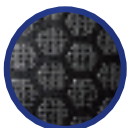

Strong industrial finish (hexagone anti-slip)

Learn more, watch demo videos and build your stage online at www.s101.intellistage.com



Folding stage

4 ft x 8 ft stage101 slim folding stage platform with casters, adjustable to thr



fst-fsfpi

code	description	price
fst-fsfpi	4 FT X 8 FT STAGE101 SLIM FOLDING STAGE PLATFORM WITH CASTERS, ADJUSTABLE TO THR	€ 1280.45,-



Stairs

stage 101 stairs kit for 16" to 24" adjustable stage



code	description	price
fst-sstair1624	STAGE 101 STAIRS KIT FOR 16" TO 24" ADJUSTABLE STAGE	€ 614.3,-
fst-sstair2432	STAGE 101 STAIRS KIT FOR 24" TO 32" ADJUSTABLE STAGE	€ 946.08,-

**Skirts for all stages****stage 101 stairs kit for 16" to 24" adjustable stage**

(loop side already mounted on the skirt), hookside in the same package.
All skirts are m-1 certified for fire prevention. M-1 certification



code	description	price
tex-podiumrok6x0-2	Skirts for all stages with velcro - M-1 certification - 6x0.20m	20,12
tex-podiumrok6x0-4	Skirts for all stages with velcro - M-1 certification - 6x0.40m	25,74
tex-podiumrok6x0-6	Skirts for all stages with velcro - M-1 certification - 6x0.60m	34,22
tex-podiumrok6x0-8	Skirts for all stages with velcro - M-1 certification - 6x0.80m	41,38
tex-podiumrok6x1	Skirts for all stages with velcro - M-1 certification - 6x1m	49,33



A large grid area for taking notes, consisting of many small squares.

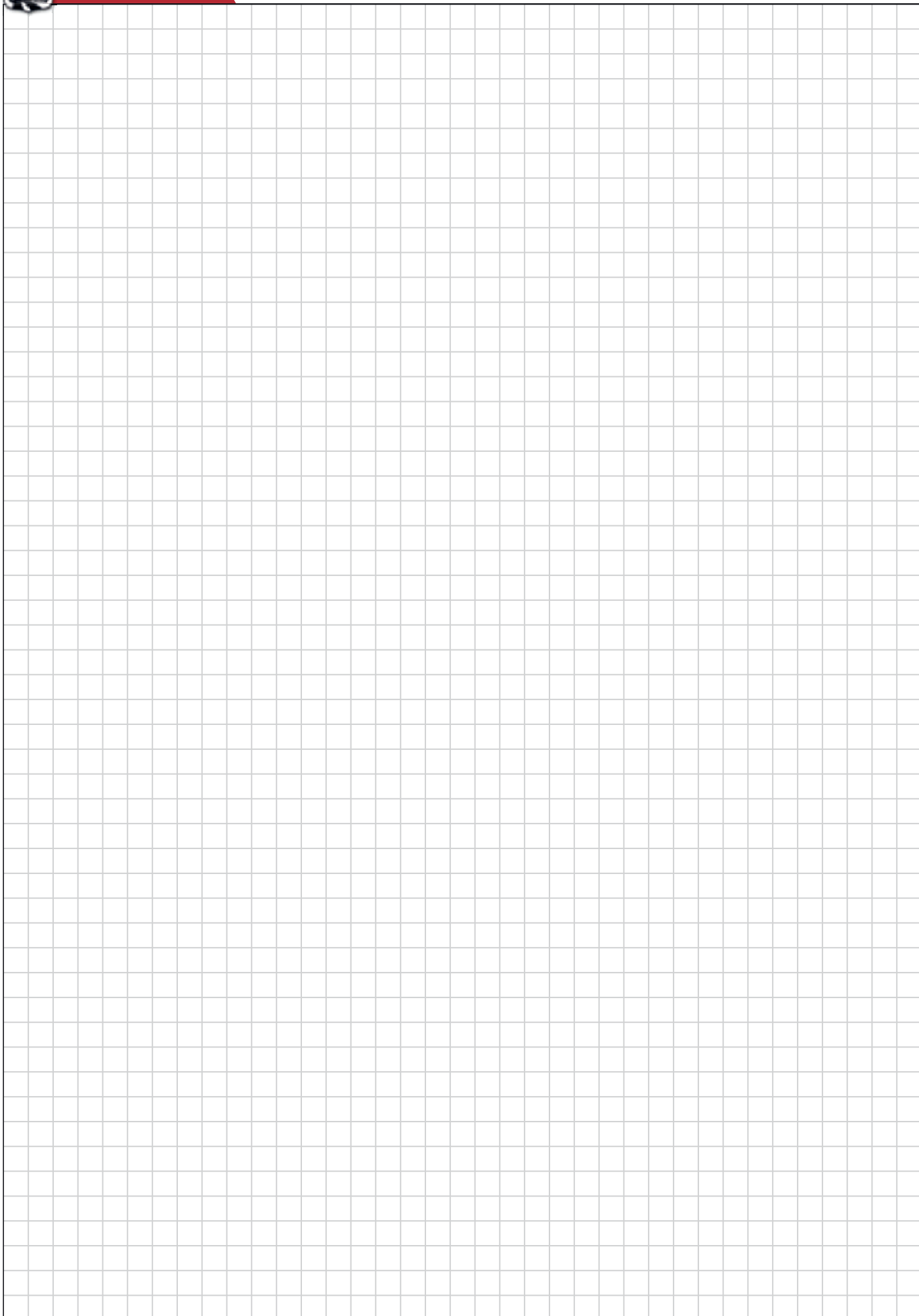

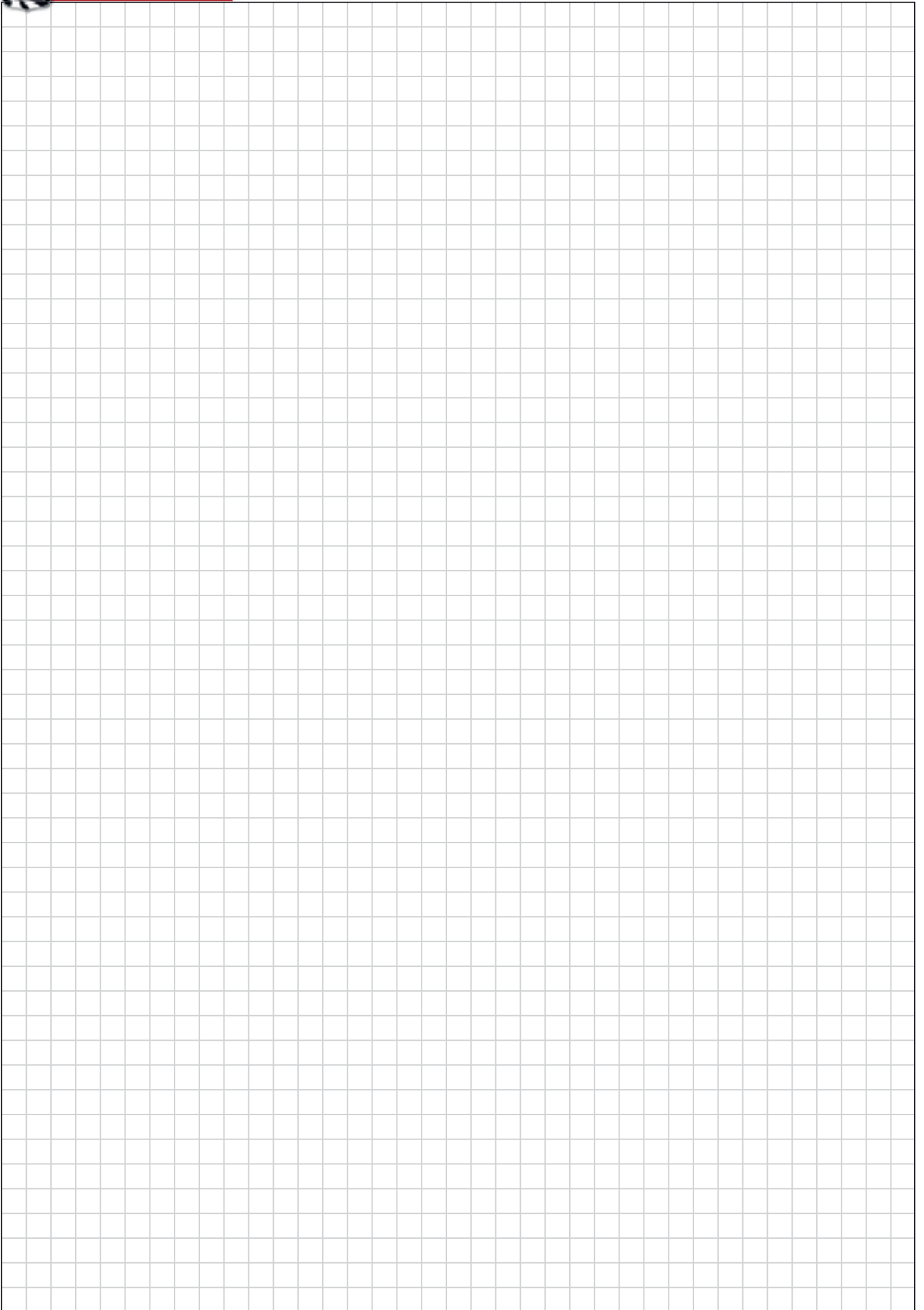

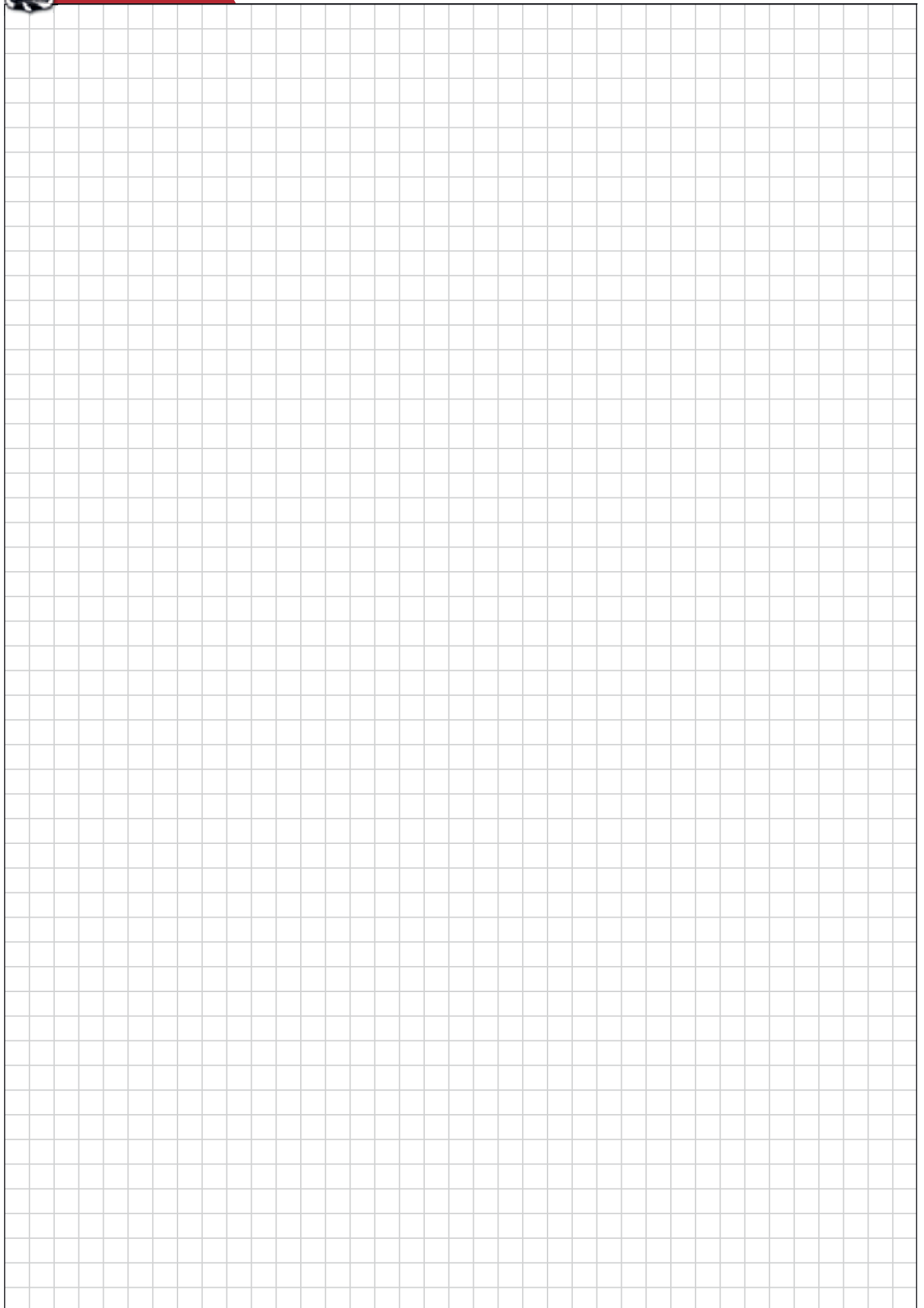

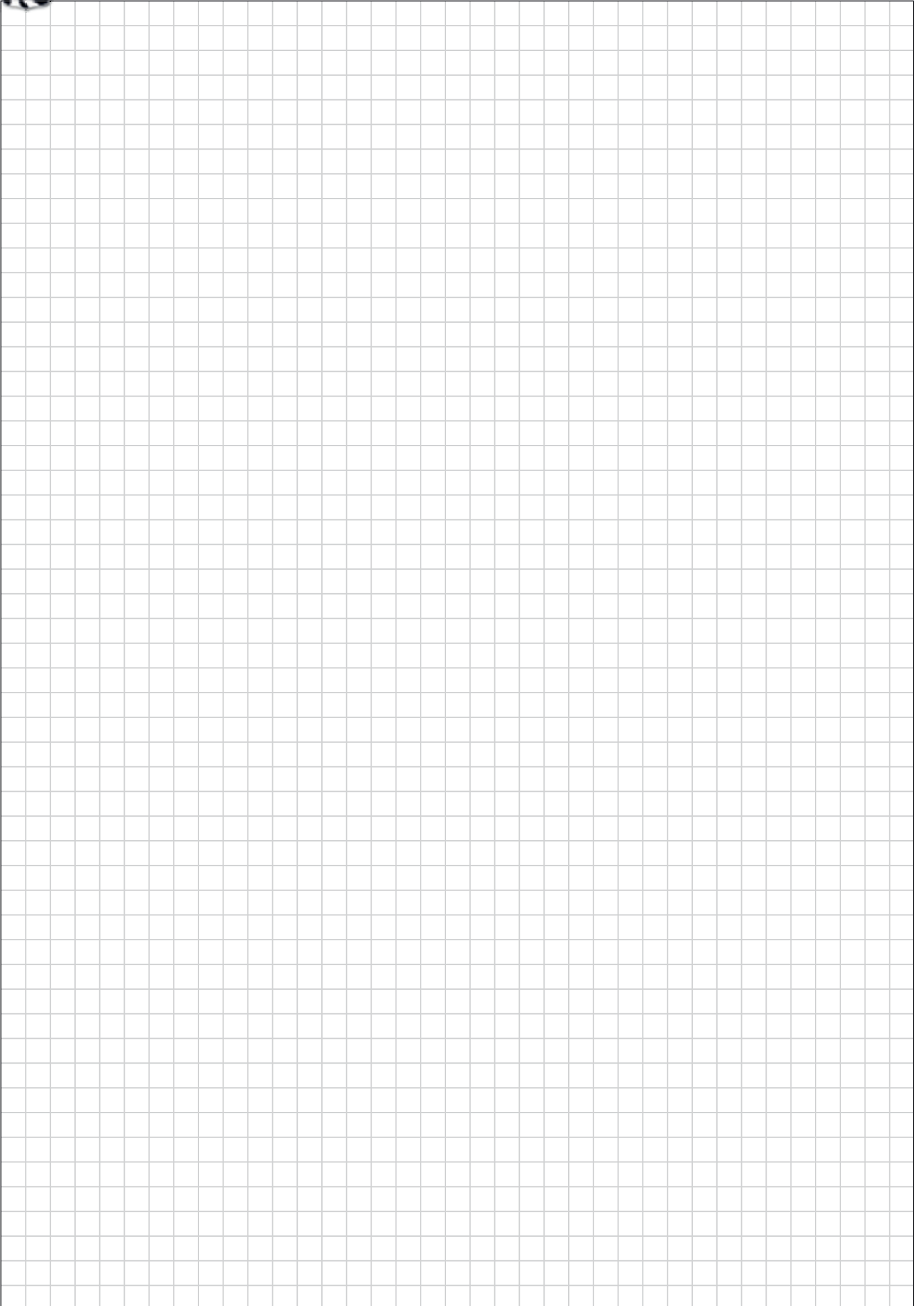

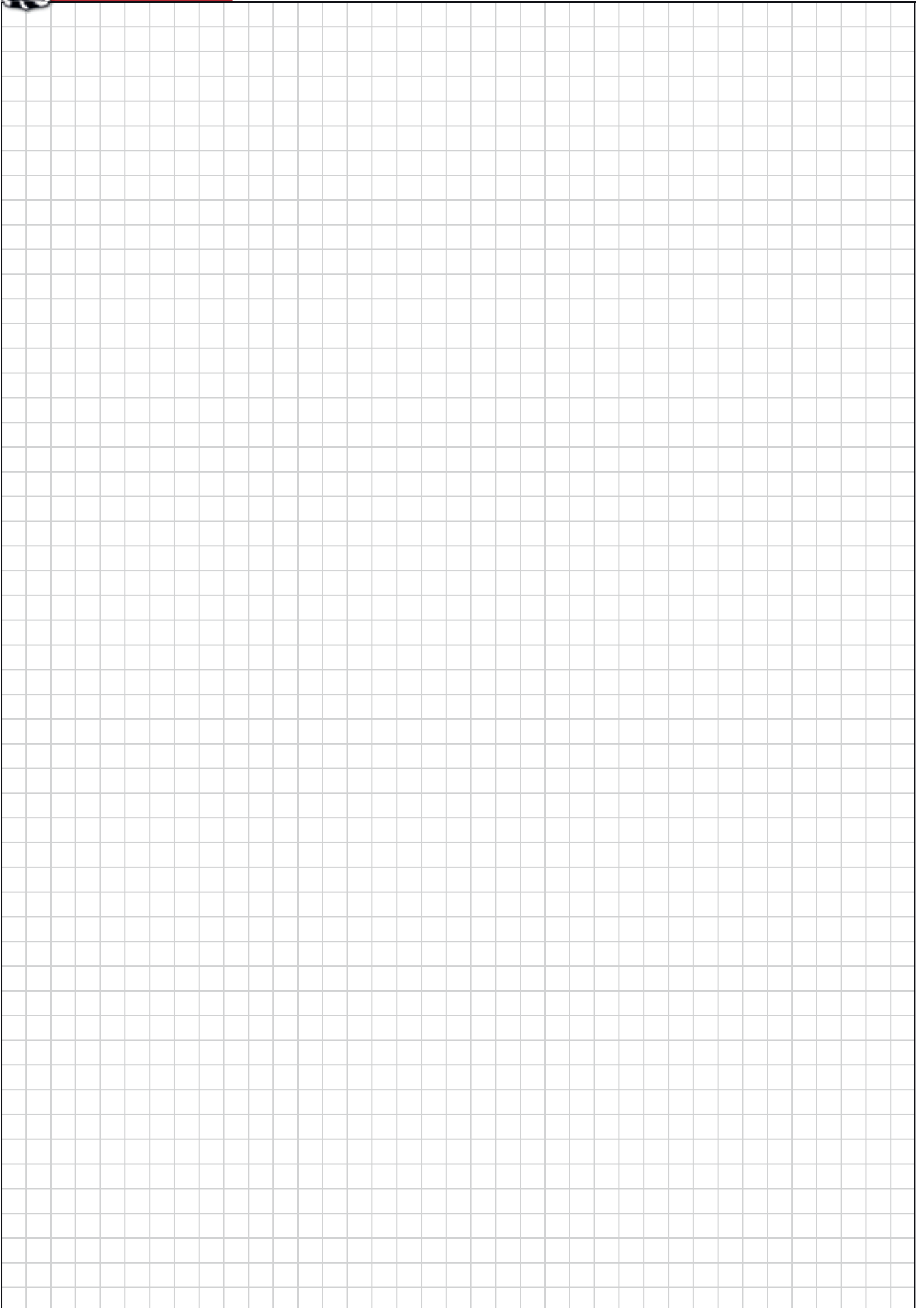

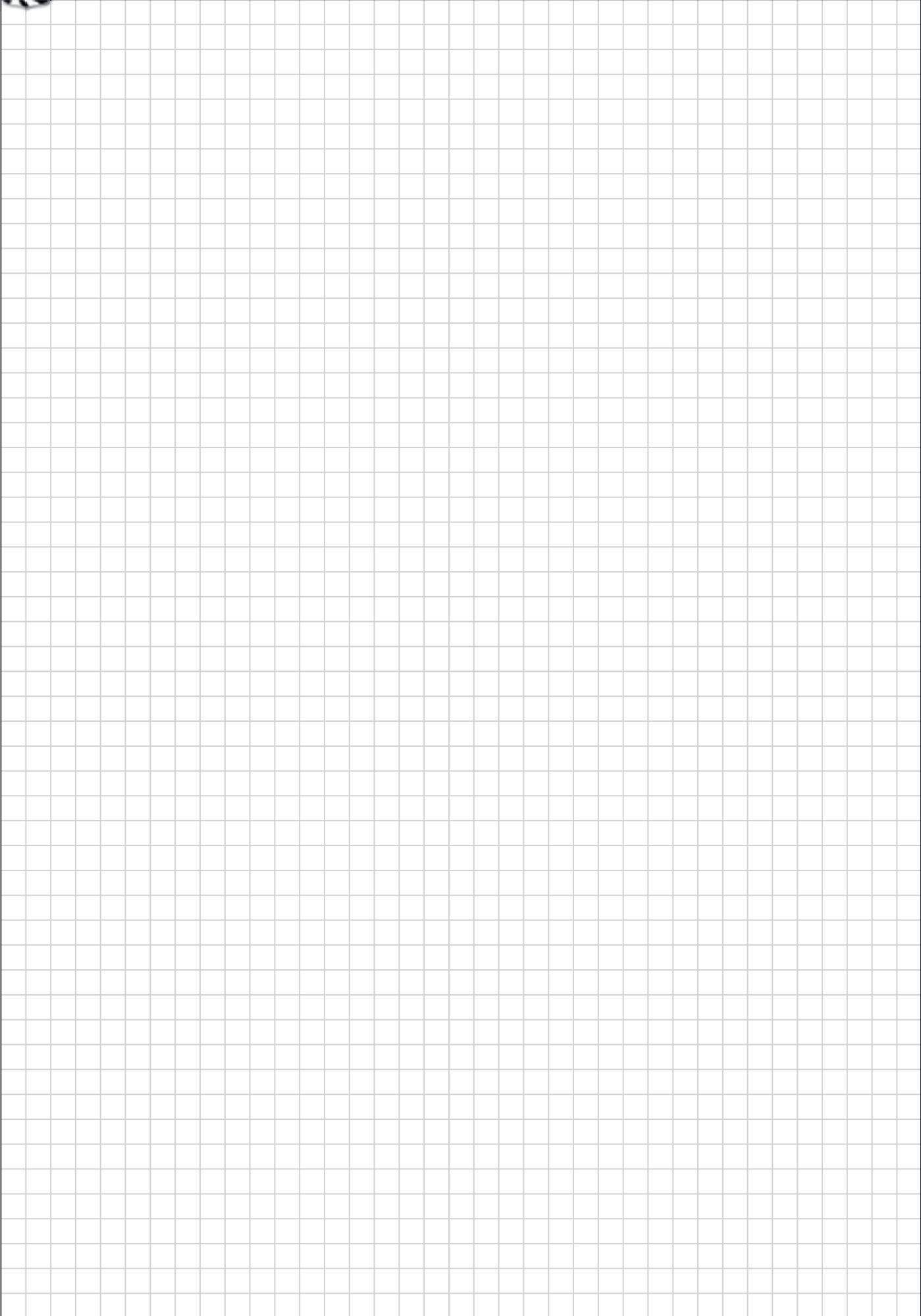

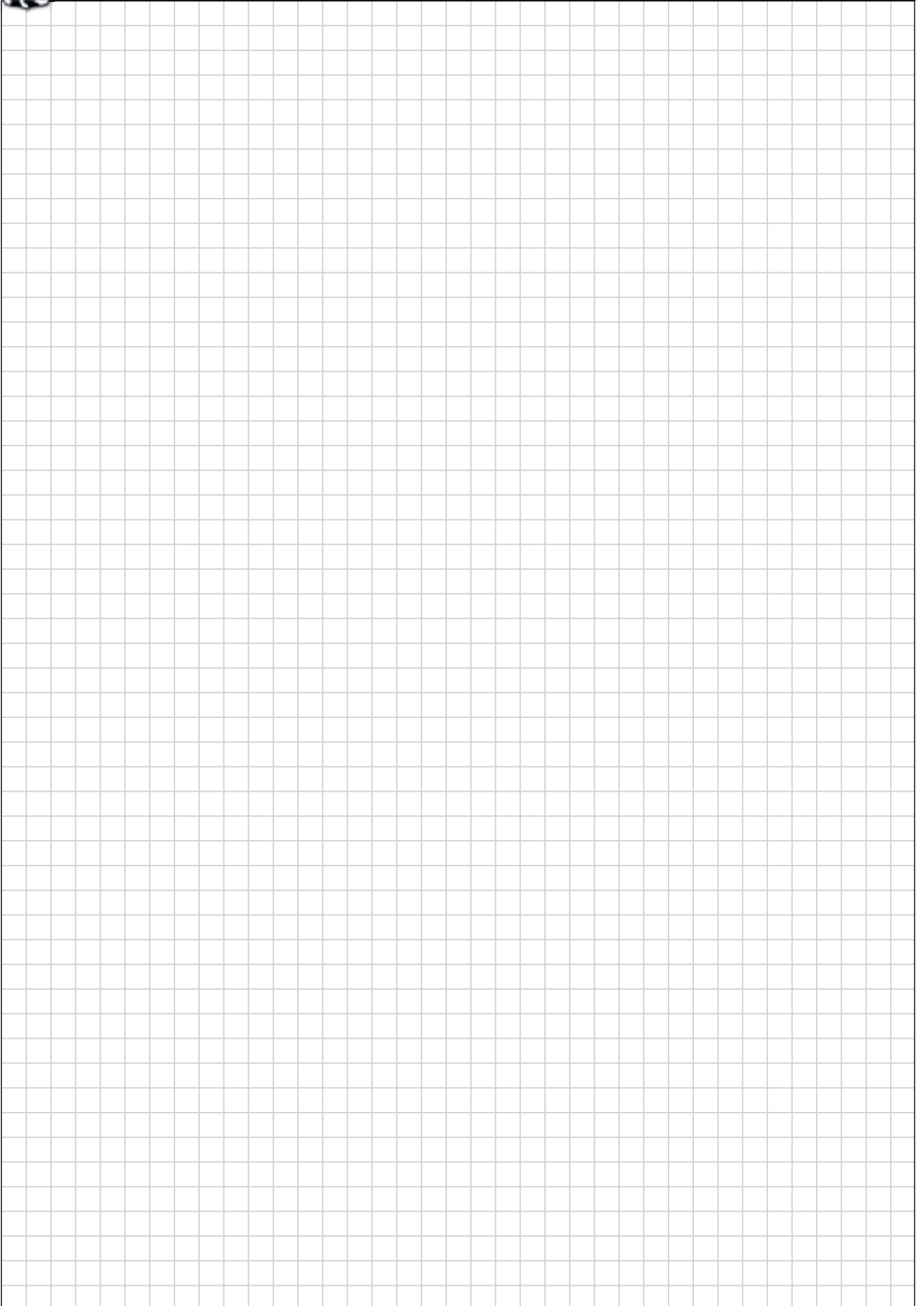

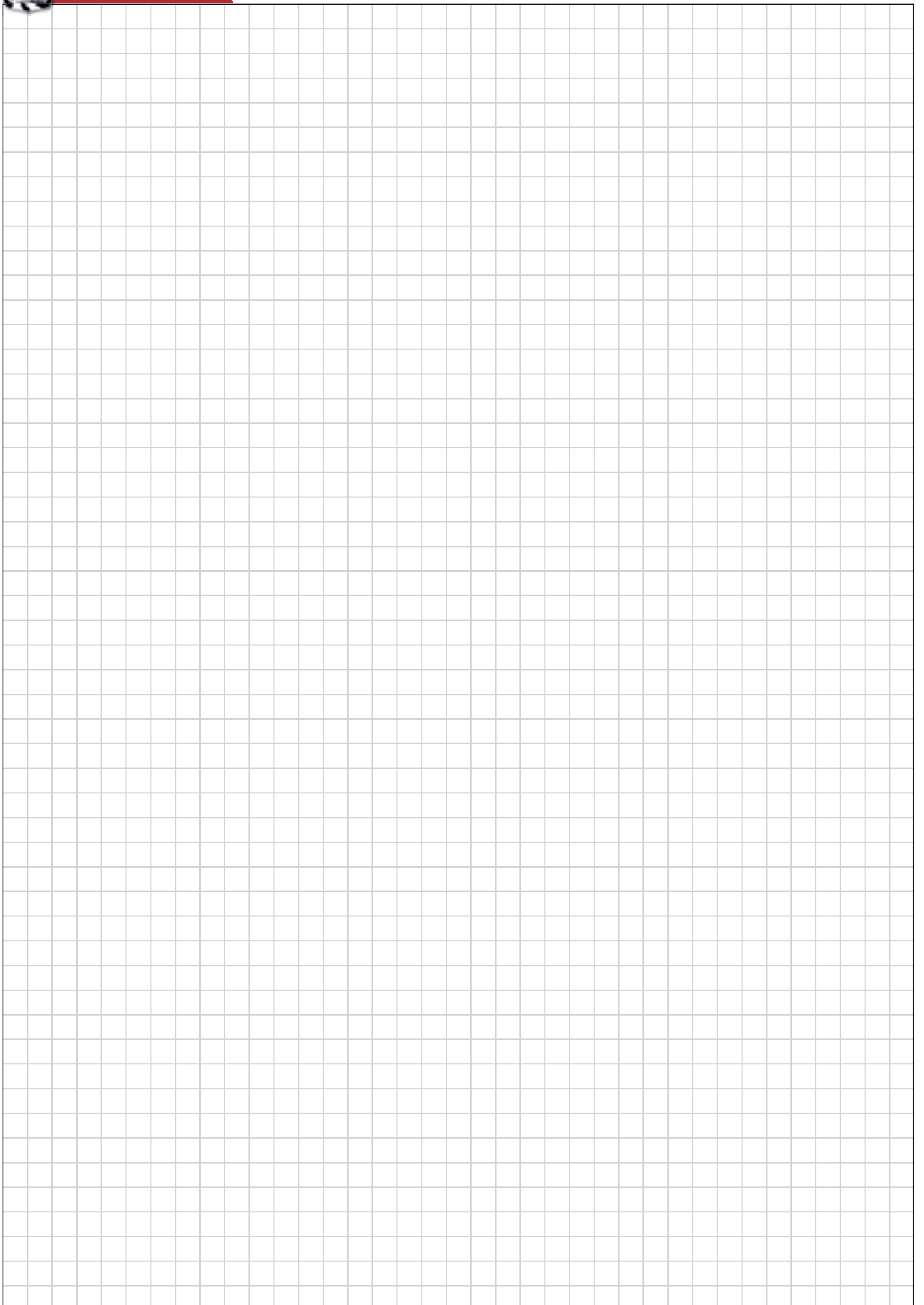

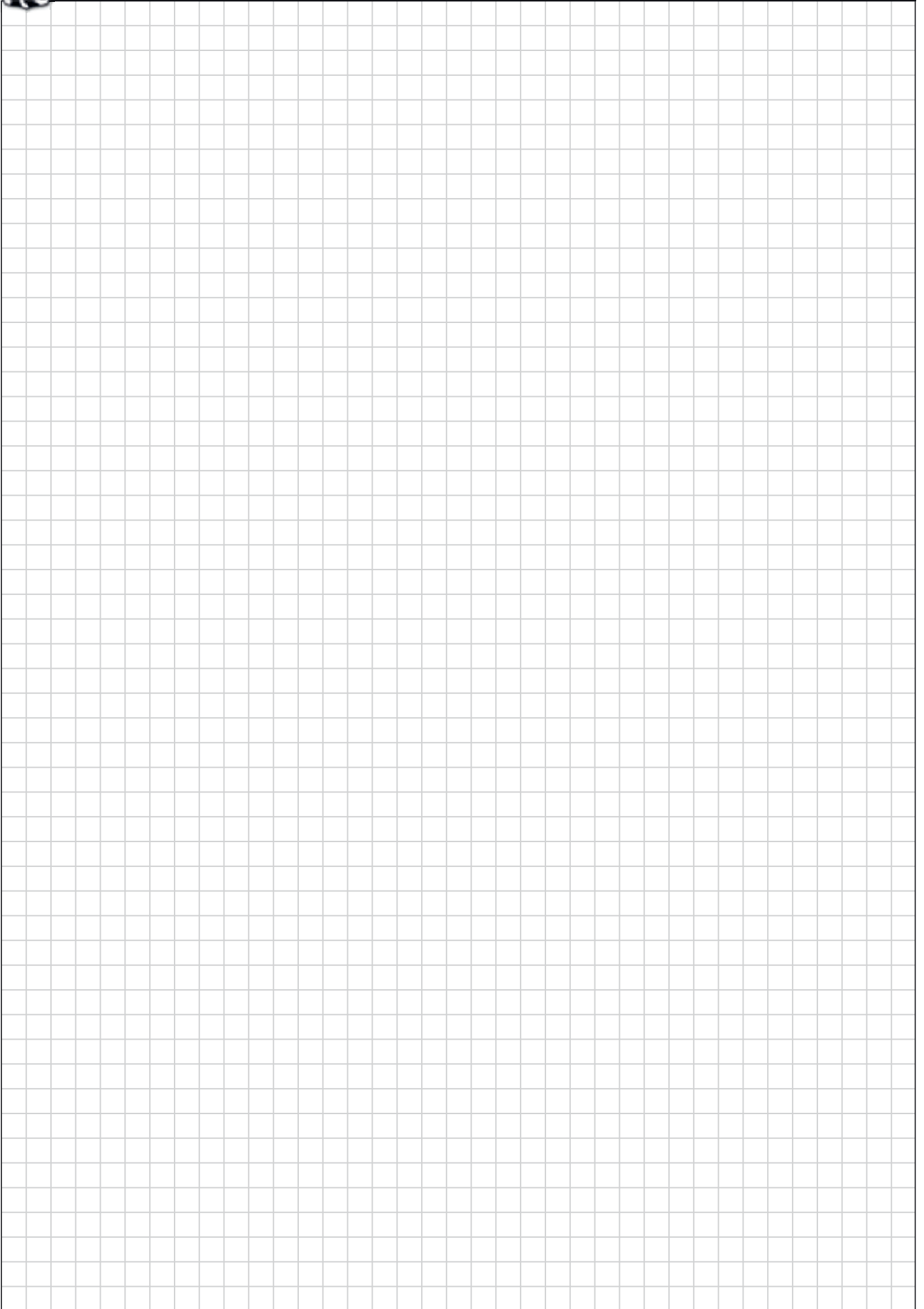



Europe

Distributed in Europe by BEKAFUN bvba
Heilig Hartstraat 23 - 8870 Izegem - Belgium
www.bekafun.com - info@bekafun.be
T +32 51 312 803
BTW BE0457542763