



# **ADMIRAL**

## **STAGING ESSENTIALS**



English version



# TO MAKE YOU SMILE ON STAGE.

**A**DMIRAL-staging essentials is all about entertainment. We like to develop and improve tools for this industry. Our goal at Admiral is to make your life easier! Most of our designs are unique and designed with comfort of use in mind. We design to improve on noise reduction, safety and health for the best possible price. Entertainment is all about smiling on stage, ADMIRAL products help you build your stages with a smile.



### MEATRACK FOR FIXTURES

Admiral offers a wide variety of transport carts. Our meat racks of 60cm width are made to transport your moving heads, lighting bars, or single luminaires. Single luminaires can be hung on aluminium or steel bars, and four or six bars can be hung on brackets.

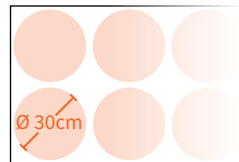

### MEATRACK FOR LARGE FIXTURES

Transporting 2kW moving heads or theatre luminaires becomes an easy task using the 80cm wide meat rack for large fixtures.

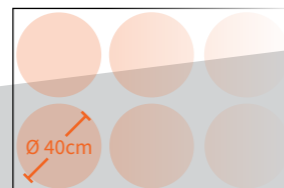

It accommodates luminaires with a diameter (or base) of 40cm. Install your hanging tubes at the desired distance and start loading!

### BALLET FLOOR CART

How will you transport your ballet or stage floor to and from your venue? The simplest solution is using the Admiral ballet floor transporter. The cart is available in two different lengths (for 150 and 180cm floors).

A sturdy plastic tube is placed at the base of this cart. This tube can be rotated with a foldable handle. After use, this handle folds between the bracket of the cart.

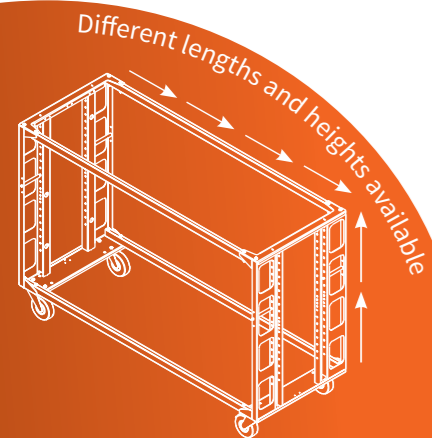



### CABLE CART

With the cable cart, you can organise all your cables easily. In addition, 80mm wide brackets prevent cables from bending too tightly and damaging internal wiring. Place several brackets next to each other or in line above each other for the most convenient layout. Cable studs can be mounted to any available Admiral cart.

### DRAPE CART

Mostly used in theatres, this drape cart is the easiest way to quickly store your theatre curtains or backdrops. Admiral offers a drape cart of 160cm and one of 250cm.

The fabric of the bag is designed to let air and moisture in and out, so your curtains can breathe to avoid decay.

We also offer an optional dust lid to store your fabrics for a longer period.

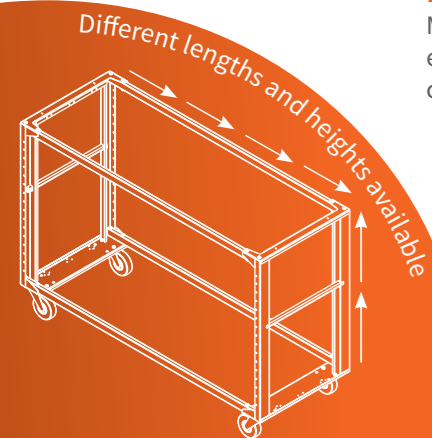

### STORAGE CART

Store and carry filter frames, cables, and tools for your event in this storage cart. The plastic containers slide easily on a bracket and are securely held in place when inserted into the cart.

### SIDELIGHT TOWERS

Sidelight towers can be equipped with moving heads, theatre luminaires, and other lighting fixtures.

The position of the hanging bar can be symmetrical or asymmetrical in this dolly, depending on what you transport: Profile spots or moving-heads.

The towers are available with or without a telescopic ladder. Ladders can be pushed upwards and a self-winding pull-strap helps you to lift the system before you insert the locking pin to secure the ladder.





**STAGE DECK\* DOLLY**

This cost effective dolly is ideal for transporting up to six stage decks. The decks can be ergonomically tilted to prevent pressure on your back.

The locking bolt is the first safety measure for the decks and a lashing set ensures further safety during the transport. This cart is suitable for most 9cm thick stage elements.

\* compatible with:  
Prolyte, Sixty82, Bütec



**NEW**

StageDex dolly  
for 1m x 1m  
decks\*



**STAGE DECK\* TRANSPORTER PRO**

We believe this is the first transporter that fits underneath a 40cm stage!

This design offers you the best options for use. You can load and unload the decks in the best possible body position. After loading the decks, an extra bracket fastens the upper sides of the decks for transportation.

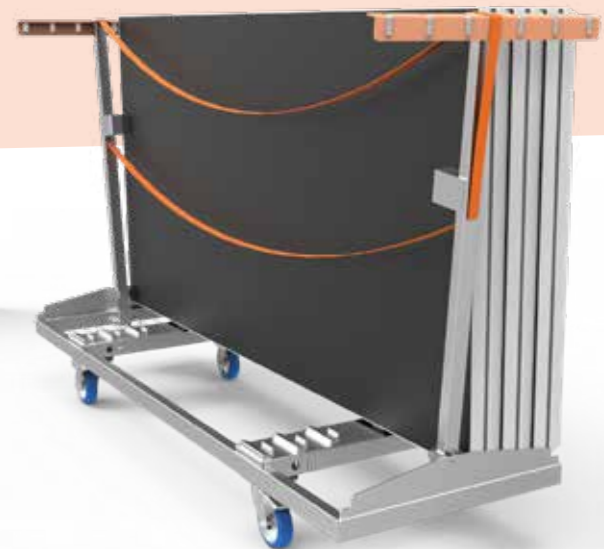

Rigid plastic parts secure each deck firmly onto the dolly and loose items can no longer be found. Last but not least, you can hide this transporter underneath a 40cm stage!

\* compatible with:  
Prolyte, Sixty82, Bütec

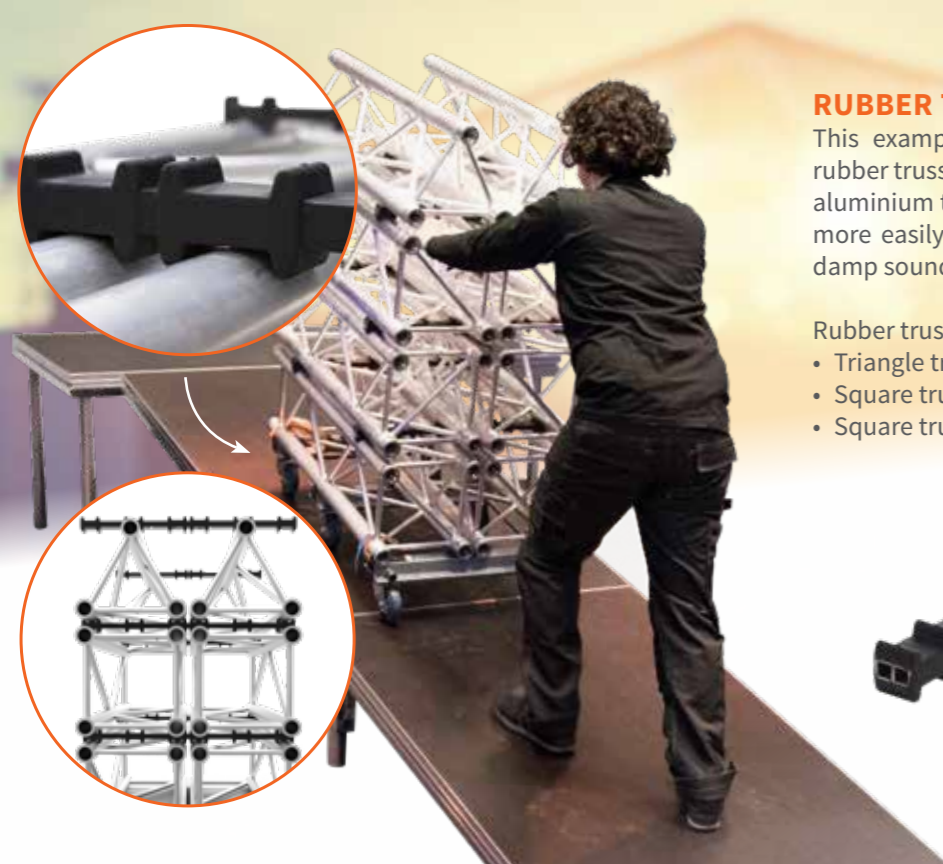

### RUBBER TRUSS CARRIER

This example perfectly demonstrates the benefits of our rubber truss carrier. Rubber studs are moulded around a rigid aluminium tube. These studs help the truss to stack together more easily with improved stability\*. They are lightweight, damp sounds, and are easy to stack.

Rubber truss carriers are available for:

- Triangle truss 30
- Square truss 30
- Square truss 40



\* We do not recommend walking uphill without a strap around your truss dolly.

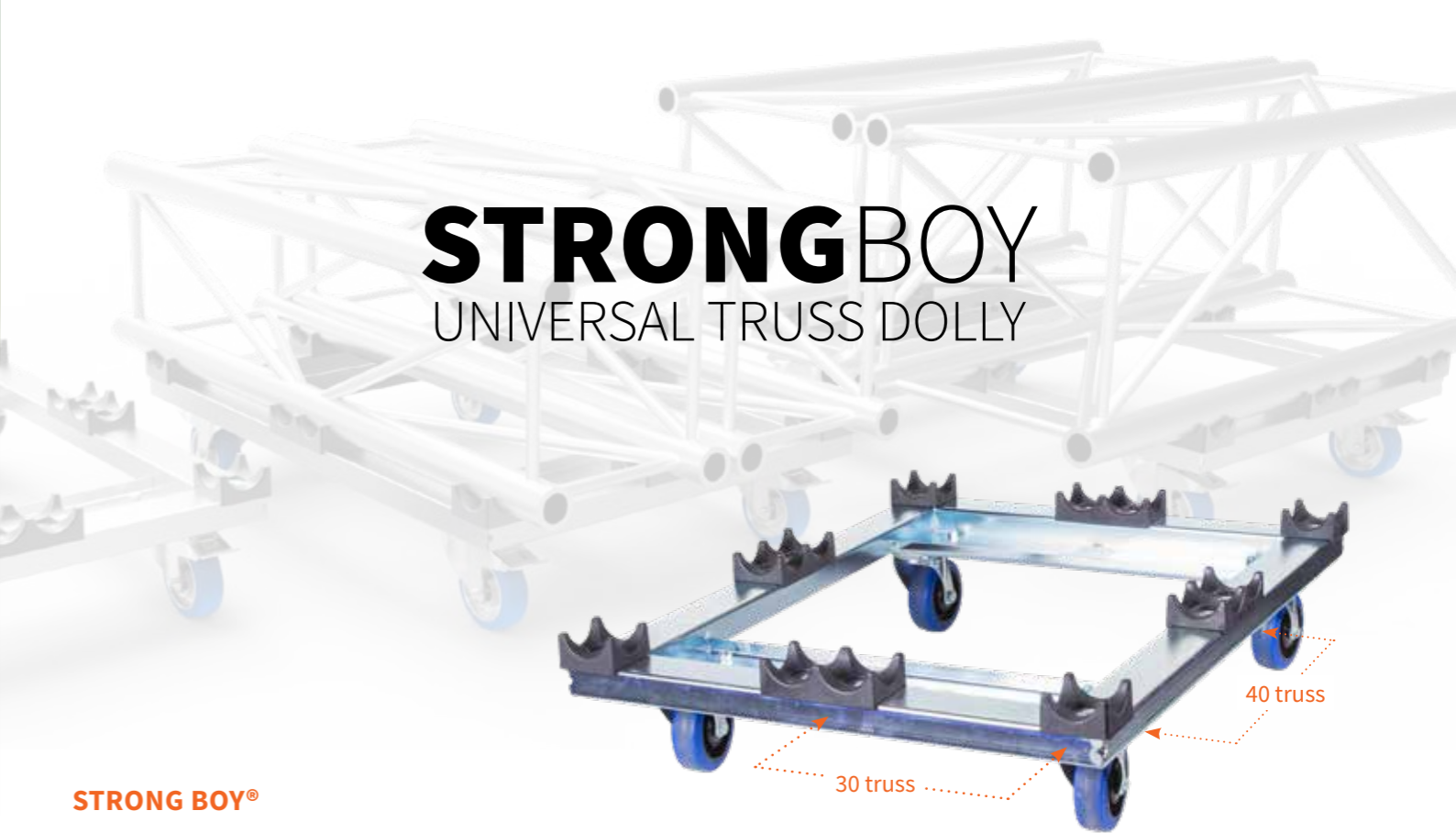

# STRONGBOY

## UNIVERSAL TRUSS DOLLY

### STRONG BOY®

We call this item our “Strong Boy”. Because this is a strong cart! Suitable for both 30 and 40 truss\*, this base is made of strong 2 and 3 mm steel. It’s zinc coated to reach the longest lifetime and equipped with rubber studs for optimal friction of your truss. From now on, shifting trusses belongs to the past. As an extra, hooks can be applied on each side of the dolly to secure the load. We predict: Strong Boy is a winner!

**\* compatible with:**  
Prolyte, Eurotruss, Fantek, Duratruss  
Globaltruss, Interl, Sixty82



stackable



for 30 and 40 truss



profile for lashing straps



storage space for carriers

For more info about our products contact your local dealer or visit our website.

[Admiralstaging.com](http://Admiralstaging.com)

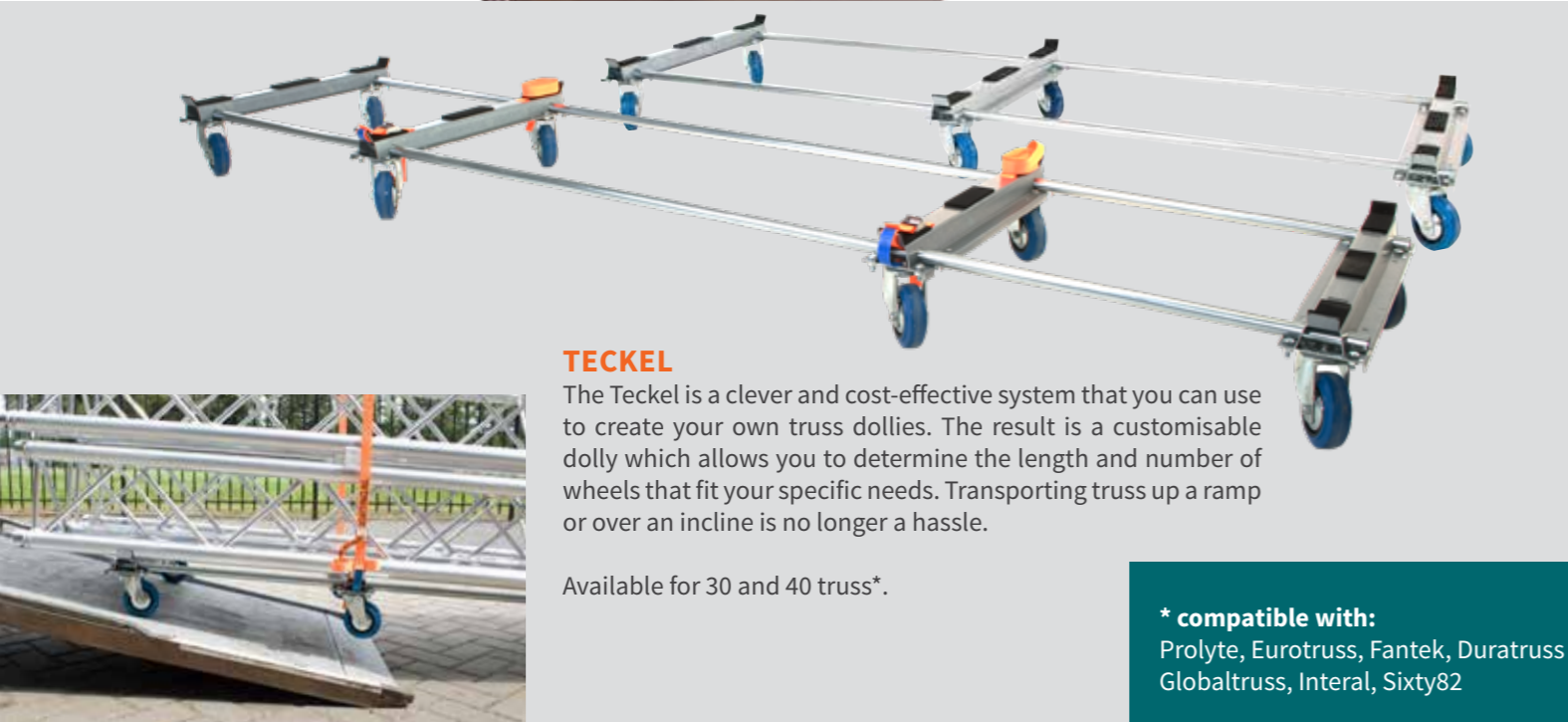

### TECKEL

The Teckel is a clever and cost-effective system that you can use to create your own truss dollies. The result is a customisable dolly which allows you to determine the length and number of wheels that fit your specific needs. Transporting truss up a ramp or over an incline is no longer a hassle.

Available for 30 and 40 truss\*.

**\* compatible with:**  
Prolyte, Eurotruss, Fantek, Duratruss  
Globaltruss, Interl, Sixty82



**BASEPLATE CART**

This 60cm wide cart can transport up to four or six baseplates.

A cleverly designed bottom element allows you to comfortably place the plates onto the car. At the last moment, the plates are tilted into a vertical position. Furthermore, sturdy 160mm wheels ensure a smooth ride over thresholds. A flightcase cover is optional.

The carts are available for baseplates of 73x73cm, 80x80cm or 100x100cm with a thickness of 6, 8 or 10mm.



**BASEPLATE HOLDER FOR FLIGHTCASE**

This holder is useful when you already have your own flightcase.

For 6, 8 and 10 mm baseplates.

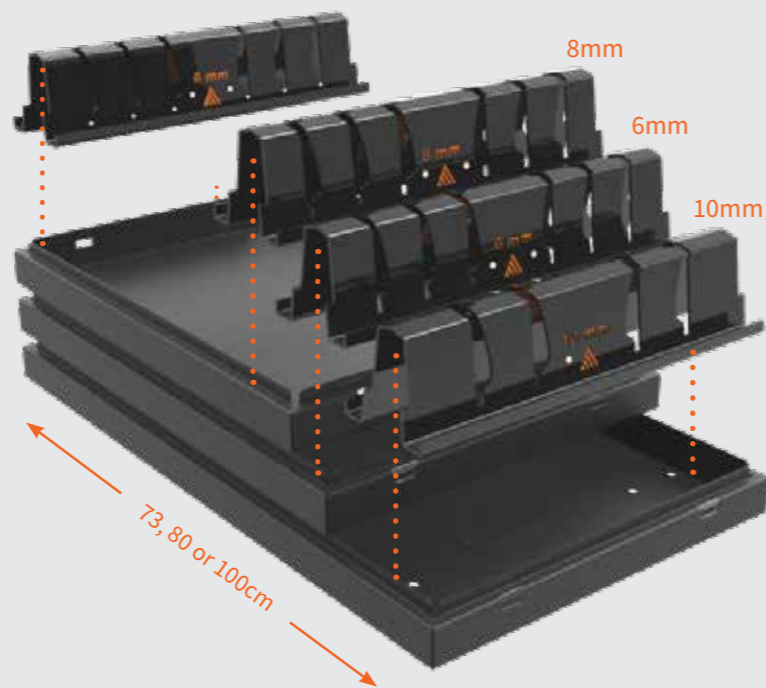

TWO BECAME ONE



**BASEPLATE 73CM COMBI FOR 30 AND 40 TRUSS\***

One plate fits all

This plate is equipped with both symmetrical and asymmetrical hole patterns. Usable for 30 and 40 truss, square and triangle\*. The asymmetrical pattern (for 30 truss) is excellent for setting up TV-screens along a wall. If you use the symmetrical pattern (both 30 and 40 truss) you can use it for tables, truss bridges or moving head bases.

**\* compatible with:**  
Prolyte, Eurotruss, Duratruss  
Globaltruss, Internal, Sixty82

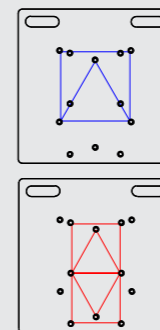
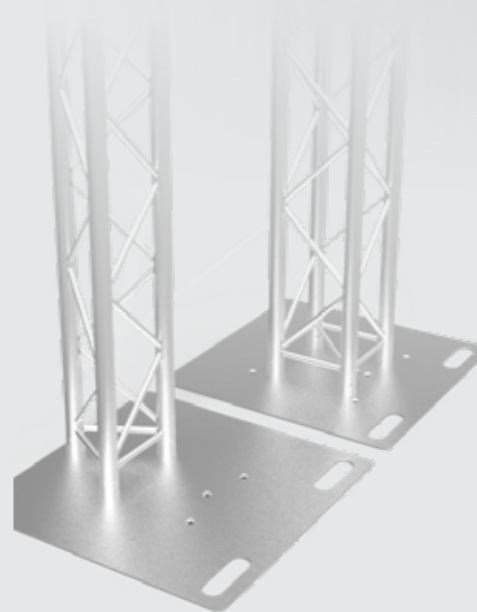

**SAFETY CABLE**

The Admiral safety cable should be mounted in a loop and be as short as possible so that if the fitting falls, the safety cable is in the best position to absorb the weight. Accident avoided.



with loop and locked carabiner  
60 cm / WLL: 100kg



with loop and carabiner  
60 cm / WLL: 100kg



with two eyelets / 60 cm / WLL: 100kg



with two eyelets  
45 cm / WLL: 100kg



**Downrigger**  
This set can be the base of your rigging design. If needed you can add extra tubes

1 Length profiles  
0.5 / 1 / 1.5 / 2m



2 Hanging tubes  
30 / 40 / 50 / 60cm



# FREEDOM<sup>®</sup> PLAYFULLY FLEXIBLE

Admiral has developed a modular rigging system that offers you all desired freedom of construction. This system can be used suspended or standing.

The length and width variations of the suspension structure vary. Multiple tubes can be slid into each other in order to change the height, while the width can be determined by various lengths of suspension tubes.

You can rig any kind of luminaire, from pars and spots to moving heads.



### Drop arm

The drop arms can be set to various lengths. If required, you can add extra lengths.



### Floor rack

We developed a floor base which can be used to construct any type of floor rack.



**ADMIRAL**  
**FREEDOM**  
PLAYFULLY FLEXIBLE

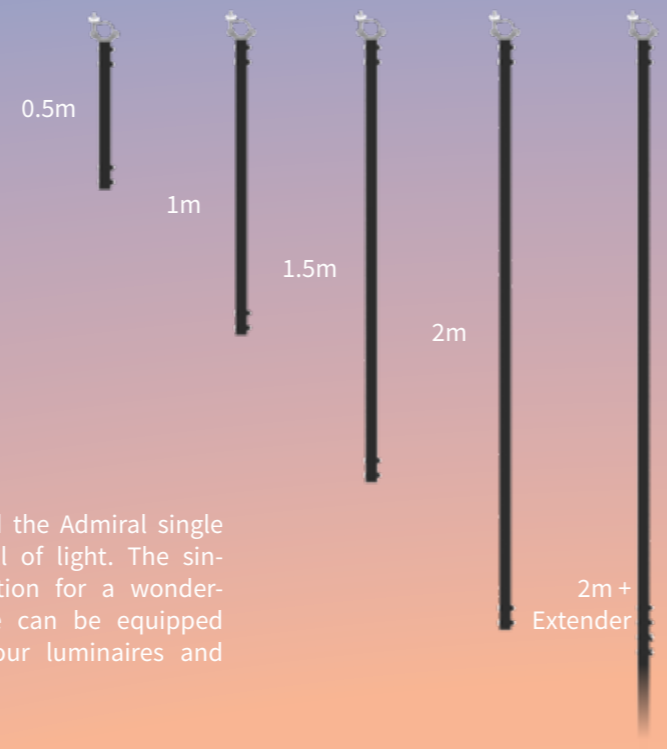

**FREEDOM SINGLE RIGGER**

Start building your light show around the Admiral single riggers and create a spectacular wall of light. The single downrigger is the simplest solution for a wonderful effect. Each Admiral length tube can be equipped with a M10 adapter to hook on your luminaires and couplers.

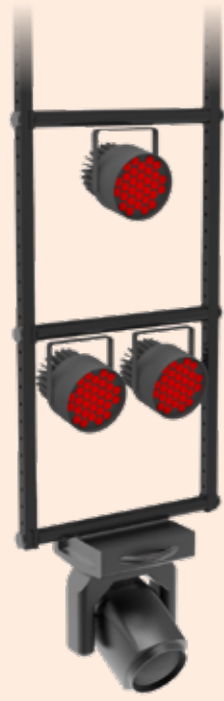

**FREEDOM DOWNRIGGERS**

Combine two elements (length profiles and hanging tubes) and make any type of downrigger possible. Each length profile can be extended. A downrigger with a drop of 6 m is no problem with the building blocks of the Admiral freedom system.

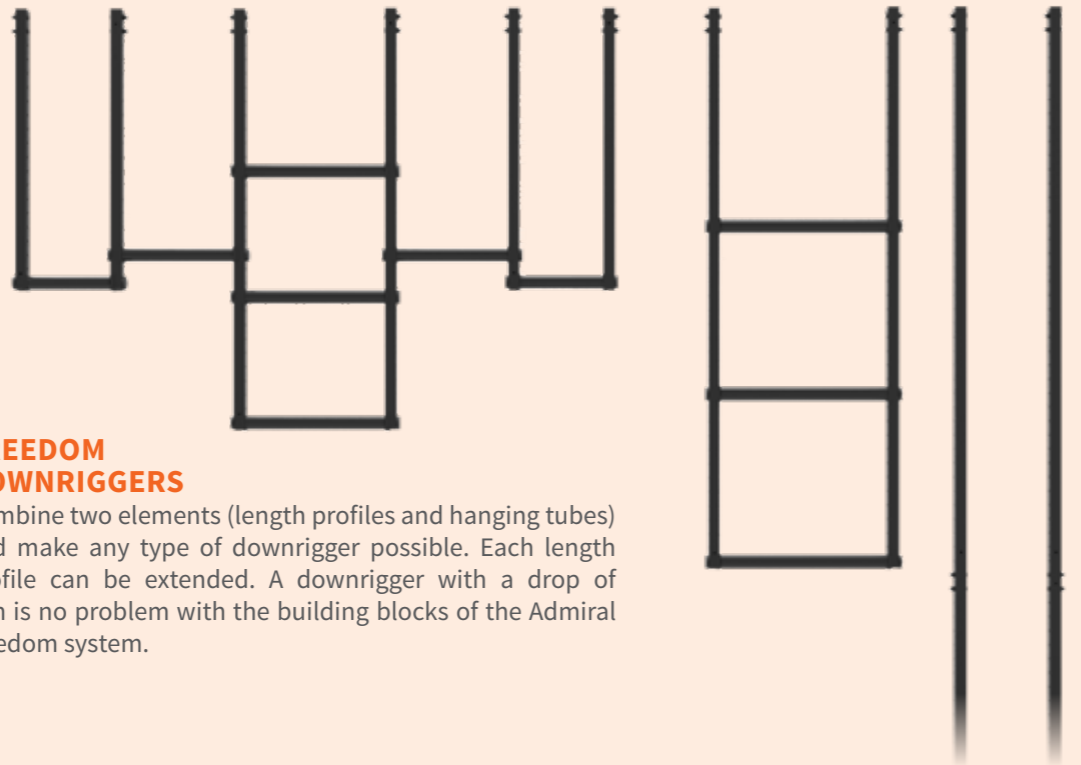

**FREEDOM FLOOR RACK**

Have you already gotten your hands on our downrigger system? Then you are one step away from using them as a lighting tower. You simply turn a downrigger upside down and slide them into our aluminium base. Your floor rack is born. You can use it as side light tower, moving head tower, or floor stand. You never bought so many applications in one. You can position your profiles symmetrically or asymmetrically into the foot.

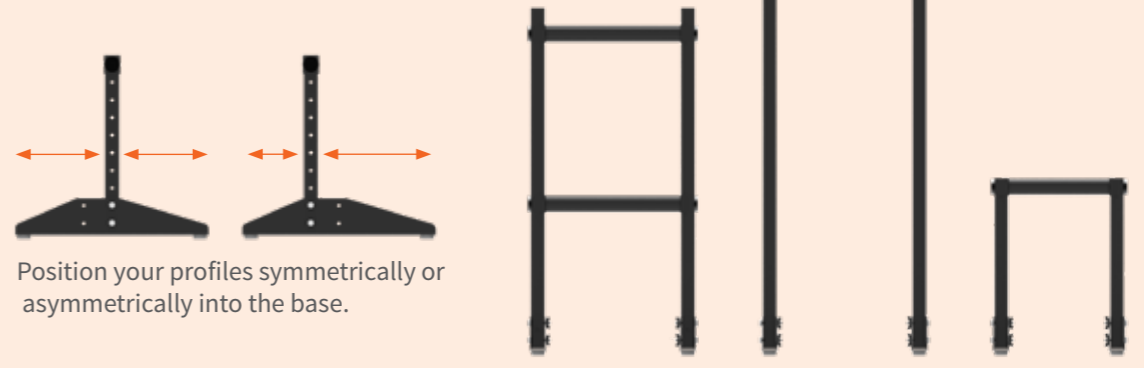

Position your profiles symmetrically or asymmetrically into the base.



**FREEDOM DROP ARMS**

You might have seen them often, but never this clever... The Admiral drop arm is extendable to any length.\* The drop arm can also be combined with hanging tubes. Imagine what lighting effect you can achieve with that!

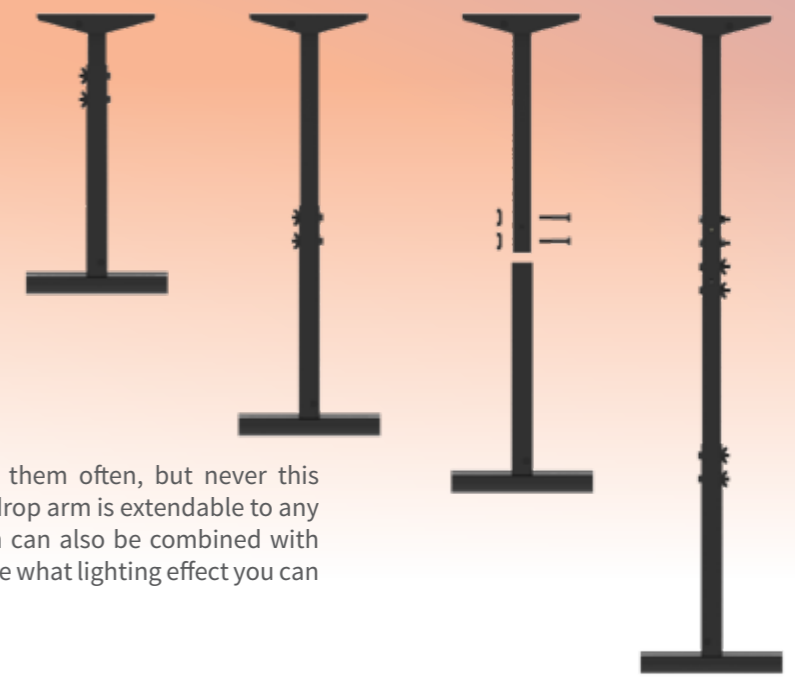

\* Stability decreases while length increase.

Halfcoupler with lifting eye



Ø 48 - 51mm  
WLL 200kg

Swivel coupler



Ø 48 - 50mm  
WLL 100kg

Ø 48 - 51mm  
WLL 500kg

Ø 48 - 51mm  
WLL 200kg

Half coupler



Ø 32 - 35mm  
WLL 75kg

Ø 48 - 50mm  
WLL 100kg

Ø 48 - 51mm  
WLL 200kg

Ø 48 - 51mm  
WLL 500kg

Ø 48 - 51mm  
WLL 750kg

M12  
Ø 48 - 51mm  
WLL 750kg

Selflock coupler

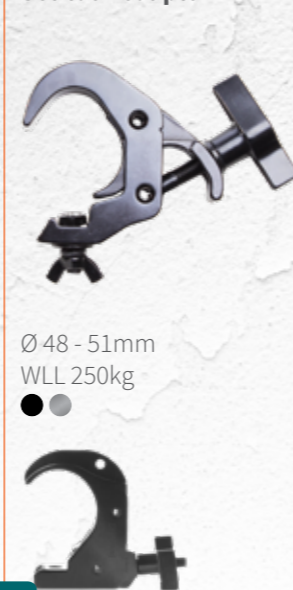

Ø 48 - 51mm  
WLL 250kg

NEW

Shorty  
Ø 30 - 50mm  
WLL 200kg

Quick coupler



Ø 48 - 51mm  
WLL 250kg

G-clamp straight



Ø 50mm  
WLL 50kg

C & G-Clamps

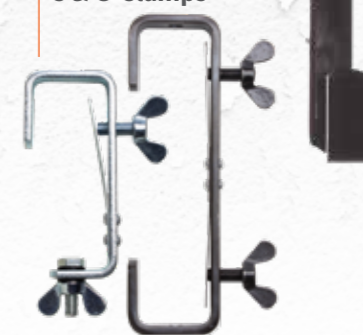

Ø 48 - 50mm  
23cm / 40cm / 60cm



SLIDE 2.0

The Slide is a game changer. It is the perfect alternative to any nut-bolt connection.



CLAMPS AND COUPLERS

Admiral supplies a vast array of clamps and couplers, from aluminum half-couplers to swivel couplers with a WLL up to 750kg.

In addition, our well-known G and C hooks are included. Fitted with a spring-steel protector to keep your truss from damage when mounting the hooks.





**FLOOR STAND®**

The Admiral floor stand is again a game changer. It is stackable, anti-slip, and it can be mounted to 30-truss to hang your fixtures.

Available with a round tube for theatre hooks/half-couplers or a flat tube for use with Admiral slide.



**MULTIBRACKET**

The Multibracket is the mounting bracket for your Funstrip or Sunstrip or similar fixtures. With this unique, patented mounting bracket, you can mount your strip in any position in your truss.

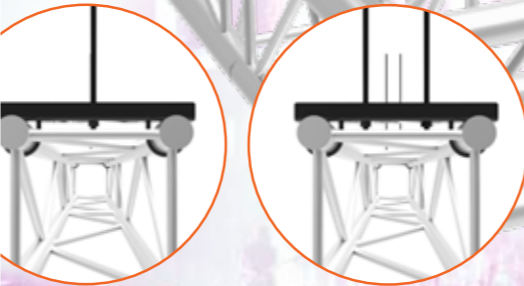
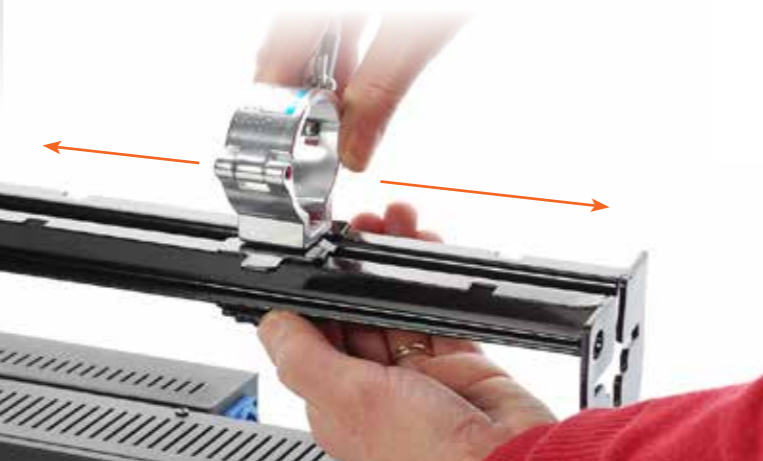

**MOUNTING BRACKET**

For fixed installation

Admiral offers an excellent bracket for trusses in a fixed installation. This mounting bracket is attached with wire brackets to firmly attach it onto your truss. Threaded rods can be applied as a single or double attachment to the ceiling.

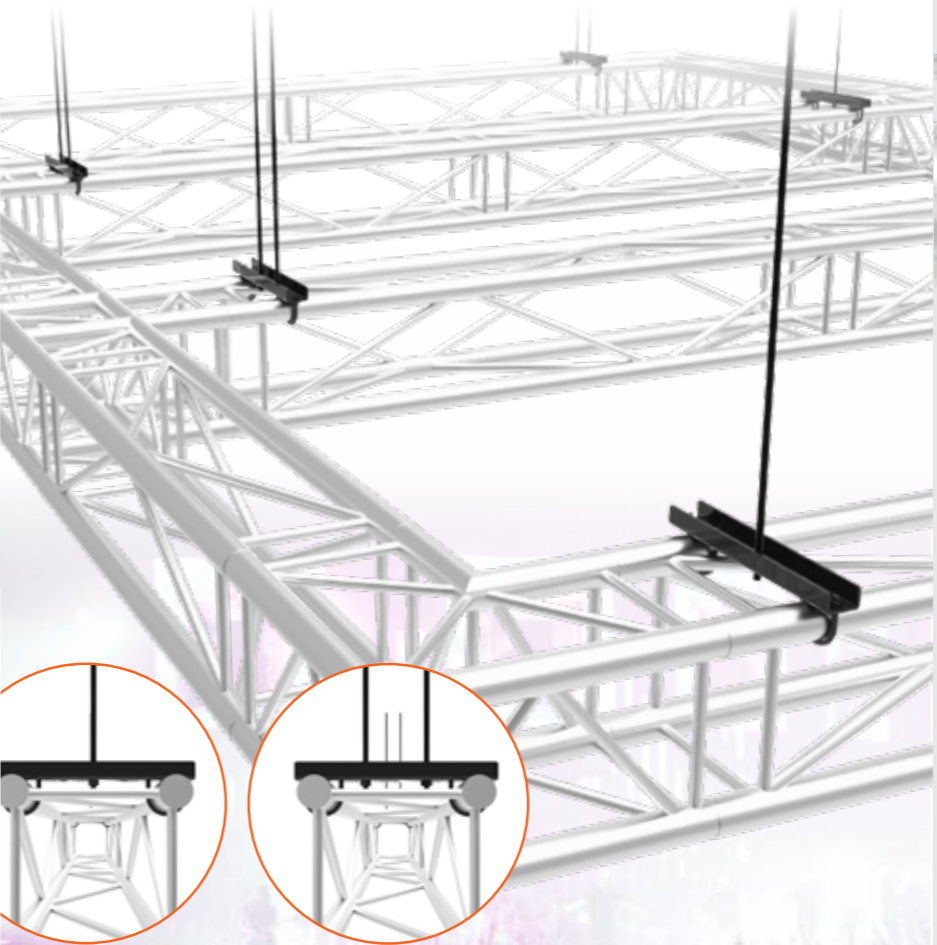

**LIFTING BRACKET**

For fixed and temporary use

Admiral's CE marked lifting brackets with a maximum lifting weight (WLL) of 500kg are available for both 30 and 40 trusses. Available in two variations: for permanent or temporary installation.



**SNAKE CABLE GUIDE®**

The latest development in the field of cable guides is the Snake. The Snake accommodates enough cables for power and signal. Pivoting hinges, moreover, ensure the cables can be smoothly bent while keeping a minimum diameter. Interlinking only 1m parts, any base can be configured.

Because of the innovative bending hinges, which make full use of an interlocking mechanism, back and forth movement of the truss while hoisting it up or down is almost a thing of the past. With its bronze bearings, this construction ensures years of enjoyment.



**ONE METER SNAKE SEGMENT FOR ALL BASES**

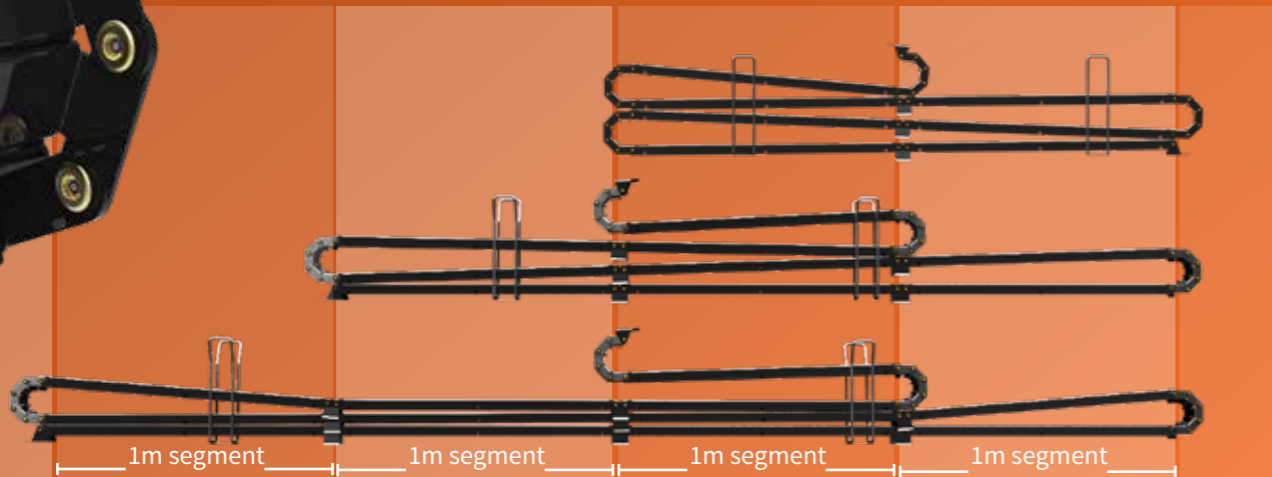

Available in black and zinc plated metal

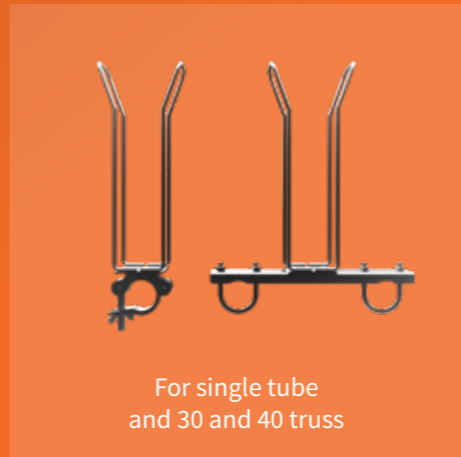

For single tube and 30 and 40 truss

**CABLE GUIDE COMPACT**

A compact aluminum system with a tray width of 5cm. This system is designed especially for use of single tubes. This cable guide is available in two lengths and many lifting heights.



**CABLE GUIDE BASIC**

The basic cable guides are a cost-effective solution for routing data and/or power cables upon truss constructions that are hoisted.





## BUILDING A GRID

Admiral has a number of different construction components for installing a grid. These include in height adjustable mounting brackets, wall mounts, and grid tube connectors.

A combination of bars with AC sockets and DMX connectors and grid tubing will create the ideal infrastructure for your theatre, concert venue, or pop centre.

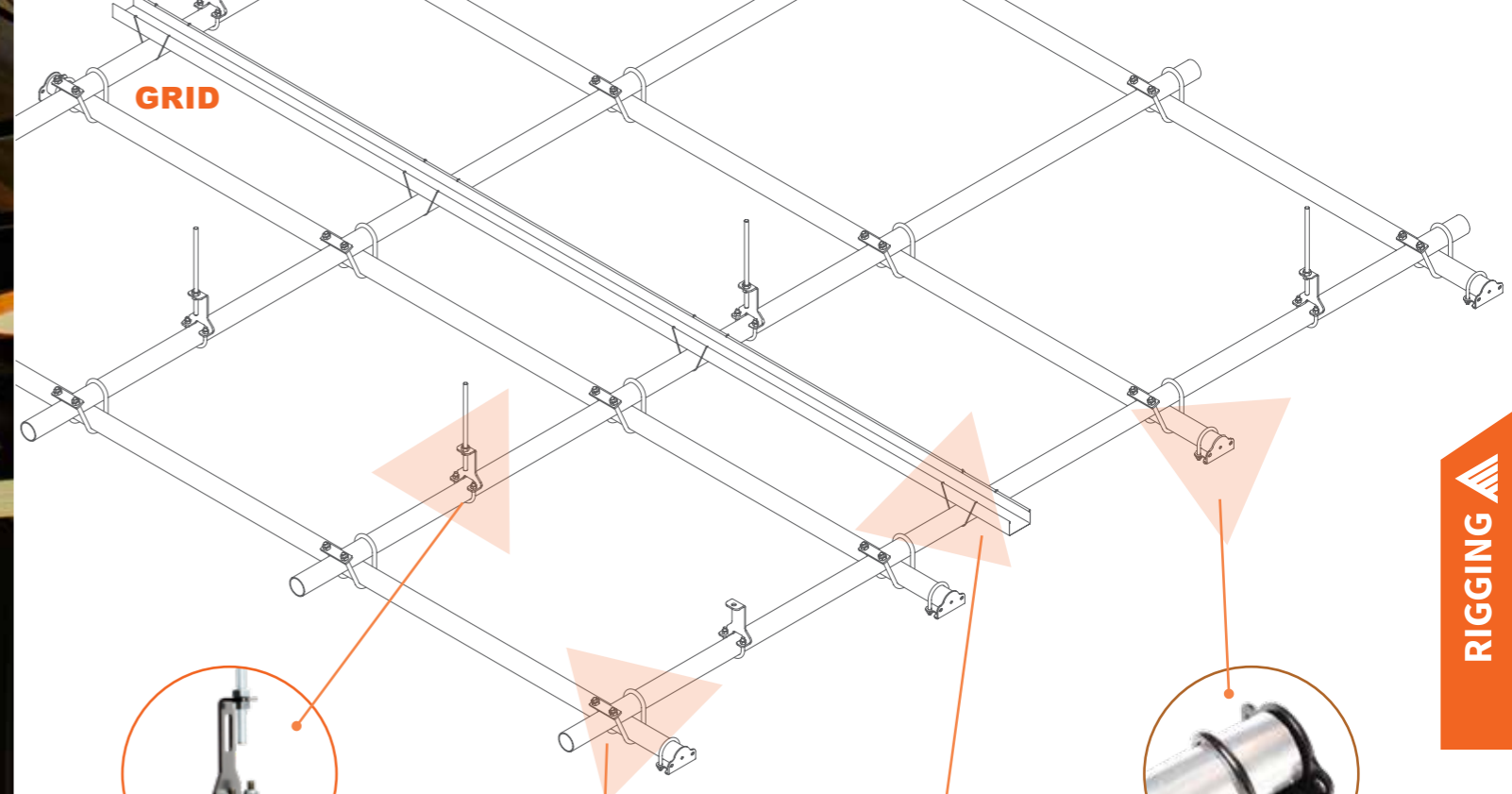

**GRID BRACKETS**  
adjustable in height



**GRID WALL MOUNT**  
for 48-51cm tubing



**GRID CONNECTOR**  
for two tubes of  
90 degrees (50mm)



**MOUNTING CLAMP**  
for cable tray to  
50mm grid tubing



**GRID TUBE JOINT**  
Length= 20cm  
(for 50mm tube)



**GRID TUBE COVER**  
Cover/plug for grid tube  
50mm



### RAMP SUPPORT

Always struggling how to build a ramp to your stage? Not anymore. With the Admiral ramp support, you can build a ramp of either 4m or 6m in length using your Prolyte StageDex, Bütec and Sixty82 stagedecks. Ramp support is equipped with a unique adjustment feature so that you can use your standard round legs to build ramps ranging from 40cm to 140cm in height.

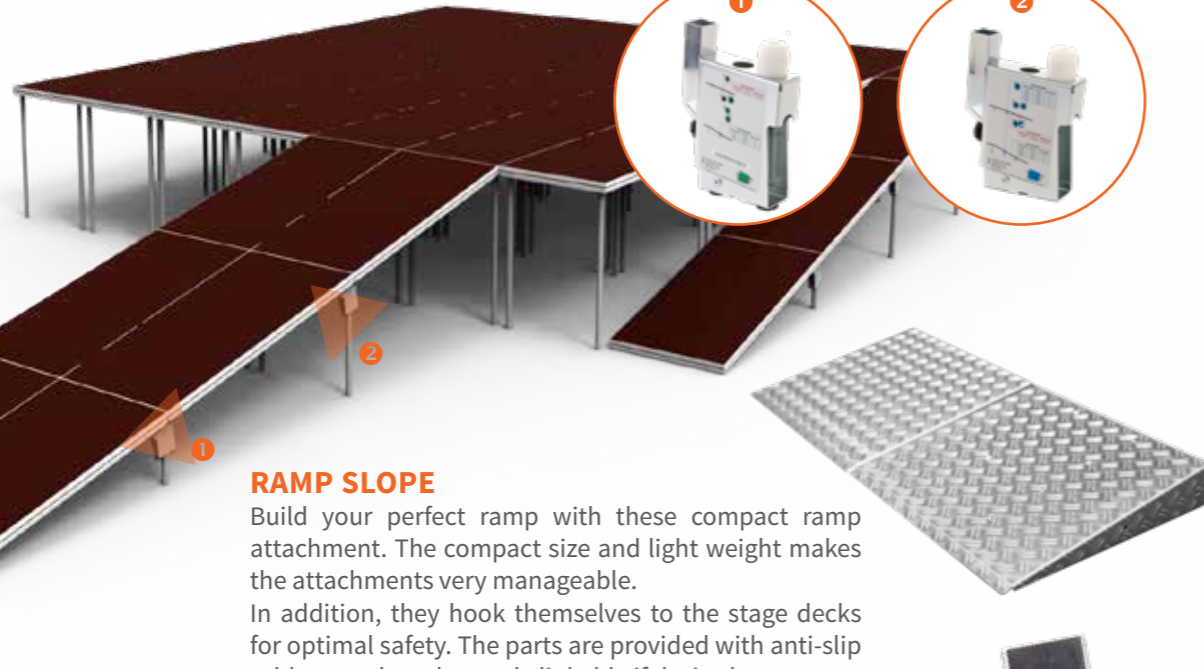

### RAMP SLOPE

Build your perfect ramp with these compact ramp attachment. The compact size and light weight makes the attachments very manageable. In addition, they hook themselves to the stage decks for optimal safety. The parts are provided with anti-slip rubbers and can be made linkable if desired.



### UNIVERSAL RAMP SUPPORT

You will often only need one type of Ramp Support to build your desired ramp. The Universal Ramp Support has been designed to fit stages that are rising by 15cm or 20cm increments.

A matching set of legs is available for each length/height of the ramp.



### LIFTING WHEEL

This lifting wheel provides many possibilities you've never dreamed possible. The wheel moves up and down 4cm and can be used for different applications.



### 1 BOX RISER

The mounting plate attachment is the solution that can attach the lifting wheels onto wood.



### 2 TRUSS MOVER

By means of our truss attachment, you can rise truss frames and roll them from the stage as a riser!



### 3 STAGE RISER

This application is for use underneath a stage riser. In the past, these risers were moved around by using a stage leg with a mounted wheel.

Our system is different and gives you two advantages. Using halfcouplers, the lifting wheel can be mounted on a standard leg. When lowering the stage onto its own feet, you experience greater stability and the maximum load can be applied to your stagedeck.



You rock we roll!

**DECO MOLTON**

Skirting your stage has never been faster and easier. With our various sizes of deco-molton rolls, you can instantly create beautiful stages.

Deco molton is available in black and white. One roll contains 60m of deco molton. Available in 20cm, 40cm, 60cm, 73cm, 80cm and 100cm heights.



320 gram p/m<sup>2</sup>  
High quality fabric

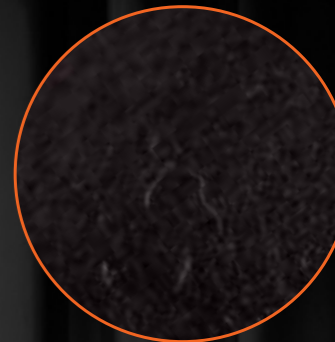

Pre-assembled eyelets  
○ ← 25cm → ○

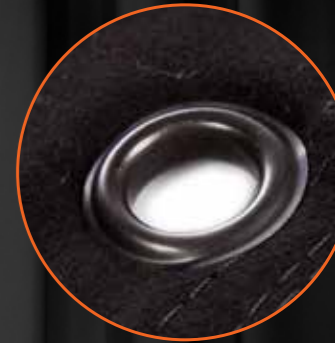

**BACKDROPS 320** GRAMS P / M<sup>2</sup>

You'll receive the best value for money with Admiral backdrops. The fabric is stronger than most 300 g/m<sup>2</sup> currently available on the market. Available in various sizes and easy to mount using the pre-existing black eyelets separated by 25cm each.

Available in two standard widths (3 and 6m) with a length of 3, 4, 5, or 6m.



### VINTAGE LUMINAIRE

You can use these decoration fixtures for your TV shows, theatre productions or for live bands to create a specific atmosphere. These lights are for decorative purposes only. They are equipped with two brackets so they can stand as a floor spot or hang in line.

The fixture has a golden reflector finish and two concentric black metal rings to provide that vintage spotlight look.



Ø 38cm and 53cm



### SMOKE VENTILATION 3-SPEED FAN

This lightweight fan makes sure there is perfect airflow for distribution of your haze or fog. The Admiral fan has a diameter of 30cm and provides 3 options of speed.



3 speeds



adjustable angle







# CABLE PROTECTOR

## 2,3 and 5 channels

This product protects your expensive cables from vehicles and audiences. These protectors are designed for use in high traffic areas. They have a solid rubber base and a bright yellow cover and are available in a various number of channels. For all models, corners of 45 degrees are available

UTILITIES



# ADMIRAL DMX



**XLR - DMX CABLES**  
Admiral offers a series of good quality, cost-effective DMX cables. The cables are available in 3- and 5- pole types and 120Ω impedance (DMX standard).



available in:  
0.5m / 1m / 1.5m / 2m / 2.5m / 3m /  
5m / 10m / 15m / 20m

**XLR - DMX CHASSIS AND CONNECTORS**  
3-pole and 5-pole chassis- and cable connectors are available.





# The show must go on



### LAMP AND CABLE TESTER

Handy tester with three useful test functions.

1. Single lamp test: test a luminaire for lamp failure.
2. Multiple lamp test: check which of your 6 or 4 bar lamps are defect.
3. Multi cable test: measure each vein of a 16-pin multi cable\*.



\*This function is possible with an additional short-circuit plug.



**NEW SIZE IS COMING**  
17 cm (extra short)

## Cable wraps

Bundle all your cables quickly, neatly, and efficiently with the Admiral cable wrap. By means of a clever wrapping system, the cable wraps will stay firmly in place around your cables. With a choice of four lengths and eight different colours, you can come up with endless applications for this product.

























### RUBBER WRAP

With this rubber band, you can quickly bundle cables in a truss or fly system. These rubber bands are provided with a hook in order to close the loop quickly. Available in various lengths.

For our products contact your local dealer or visit our website.



-  Audiosales 1
-  Axente 2
-  Bellalite 3
-  Bekafun 4
-  Cast Swiss Light Consulting 5
-  CES 6
-  Electro Waves Oy 7
-  Gobo & Highlight 8
-  Licht Produktiv 9
-  Matrix Sales 10
-  Multitechnic 11
-  Oy Lafoy Ltd 12
-  Prolight 13
-  Rolight 14
-  RTC 15
-  Siluj 16
-  SOTESA 17
-  Stonex 18
-  Sybel 19
-  S2 PRO 20
-  Prolyte Doughty Japan 21
-  Prolyte Doughty Asia Pacific 22

