

Your Partner for Light

Catalogue produits
Productcatalogus
Product Catalogue
ProduktKatalog

Edition March 2014

www.adblighting.com

ADB
Lighting Technologies

Summary



Projects & Achievements

2



Controlling

4

FREEDOM

4

LIBERTY

6

IMAGO

8

HATHOR Rack PC Unit

10

DOMINO

12

MIKADO

14

Networking

16



Dimming

18

EURODIM Twin Tech

18

EURORACK 60 DIMSWITCH

22

MEMORACK

24

MIKAPACK

26

Touring Racks

28



Lighting - Theatre Spotlights

30

Motorized WARP

30

WARP

32

EUROPE

36

"A" Range

46

EUROSPOT

48

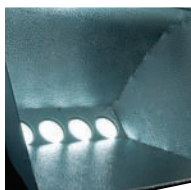

Lighting - Multi-Purpose Luminaires

50

ALC4-2

50

Cyclorama Lights ACP 1000

52

Fill Lights LF/HF 1000

54

SVOBODA

56

SOFTLUX

58

Accessories

60

A wealth of experience in stage and studio lighting, a comprehensive range of high quality products and a strong project management capability are some of the key strengths which have made of ADB the preferred partner of so many Theatre and Television Lighting Professionals around the world.



Bolshoi Theatre Moscow Russia

Whenever quality and consistent performance count leading venues around the world rely on ADB. EURODIM installation dimmers power a large array of luminaires every day.

Similar installation:
Novosibirsk Theatre, Russia,
Theatre of Nations, Russia



Metropolitan Opera New York

The totally silent WARP Motorized profile spotlights are the choice of discerning lighting professionals in many prestigious venues:

*Monnaie Opera Brussels, Belgium,
Shen Zen Concert Hall, China,
Bayerische Staatsoper, Munich Germany,
Glyndebourne Festival, United Kingdom*



Philharmony Theatre Strasbourg

In order to save energy 56 x ALC4-2 have been installed for the lighting of the philharmonic orchestra. 6 x WARP/M motorized profiles for multi position detailed lighting.

Similar cases:
Casino Oostende, Belgium,
Macau Cultural Centre, China,
C-Mine Genk, Belgium

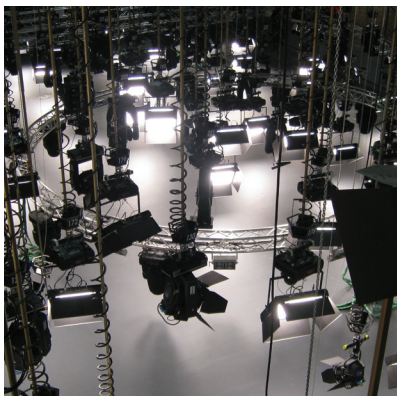

BNTV Bulgaria

Refurbishment of existing studio including: repair and redesign of 30 years telescopic elements, design and build of suspension control system and installation of complete lighting system with Control desk, dimmers and TV luminaires.



Palais Montcalm Quebec

The Salle Raoul Jobin concert hall, one of the best in the world, is equipped with Motorized WARPS.

Similar installation:
Onasio centre Athens



TV Lighting & Energy Van Algerian TV

A speciality of our project department is to design and supply custom solutions, such as this lighting van.

Should you have any specific lighting requirement, do not hesitate to contact our project department.

Projects & Achievements



BASTILLE Opera Paris - France

Replacement of dimmers originally installed for the theatre's opening in 1989 by newest EURODIM Twin Tech technology.

Many famous opera houses rely on the quality and endurance of ADB digital dimmers, such as:
Teatro alla Scala, Milano,
Bolshoi, Moscow,
Opera Garnier, Paris,
Grand Théâtre de Genève,
Switzerland



English National Opera (ENO) - London

ADB Lighting has been appointed to supply the English National Opera (ENO), based at the Coliseum in London, with a EURODIM Twin Tech dimming system, fitted with dual-mode DimSwitch dimmer modules.

Other fine venues:
Concert Haus, Vienna, Austria
Palau de les Arts Reina, Sofia, Spain
Casa di Musica, Porto, Portugal
Oriental Arts Centre, Shanghai, China
Tonhalle, Düsseldorf, Germany
Gewandhaus, Leipzig, Germany



National Theatre of Bahrain

ADB partner TELMACO has project managed and installed the complete lighting system with Twin Tech DimSwitch dimmers and luminaires from ADB.

Other references in Asia:
Shanghai Grand Theatre, China
Kimhae Cultural Centre,
Seoul, Art Centre,
Soengnam, Culture Hall, Korea
New National Theatre, Tokyo, Japan



Musiktheater Linz Austria

The Linz's Theatre is equipped with EURODIM Twin Tech technology and also with the FREEDOM control desk.

Other venue:
Youth Theatre Zagreb

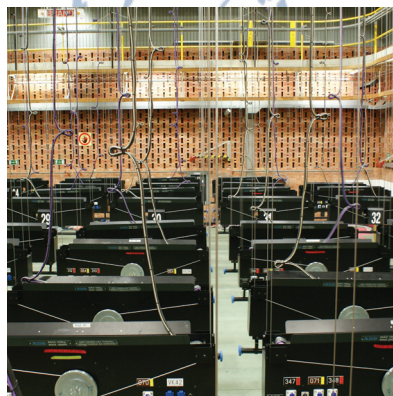

VRT - TV STUDIO Brussels Belgium

Professional Broadcasting Studios request 100% reliability and functionality.

Major broadcasters relying on ADB:
National BTV-Minsk, Belarus,
TF1 Paris,
Channel 5, 3, 11 Bangkok, Thailand,
National Television HRT, Croatia,
BBC Studios, United Kingdom,
DIGI24, Bucharest, Romania,
Media Center, Turkmenistan,
NHK, Osaka,
ITV Television, Taiwan

An impressive reference list is available upon request.

Controlling

FREEDOM



The state of the art lighting and show control tool when more multi-parameter instruments are needed to be controlled and fast access is required. Together with the LIBERTY console this range is ideal for all venues seeking a fully integrated solution to control conventional and moving lights as well as LED sources and other modern equipment in a portable package.

FREEDOM features four additional rotary wheels with pushbutton function and a super smooth large size trackball for precision positioning control. Updated with a new Moving Light library, including over 10000 fixtures, FREEDOM allows users to control quantities of multiple LED fittings, intelligent lights or media servers as well as the standard generic dimming systems.

Four physical DMX outputs and one physical DMX512 input on board with 5 pole standard XLR connection sockets can be used in case no ETHERNET network is available.

Highly intuitive thanks to the graphical user interface and powered by the HATHOR software this desk meets the sophisticated needs of all lighting professional. The lighting control desk philosophy has been specifically designed for theatre stage lighting without any compromise.

FREEDOM is available in five basic configurations controlling channel numbering from 120 to 2048 multi-parameter lighting instruments and can address up to 32 universes via suitable networks. Synchronised backup is optionally available. FREEDOM consoles perform as standalone or as a client consoles in an extended networked system. Networked FREEDOM consoles will support multi-user / multi-operator setups with optional software packages and hence works perfectly together with other control desks powered by HATHOR software.

FREEDOM comes with an SSD disk drive, which makes the console extremely silent and improves the boot-up time.

Playbacks

- 1 Grandmaster with Blackout key.
- 24 physicals Submasters with assign key and Flash key.
- Modes: Solo / Inhibit / Focusing / Rubberband & Auto-execute look.
- Loading possibilities: Channels, Groups, Presets, Looks.
- Chasers, Attributes and Palettes.
- 1 Master Playback 100 mm (Sequential Theatrical Crossfade).
- GO / GO BACK / PAUSE / Jump / SEQ- & SEQ + keys.
- 1 Intensity / Speed control wheel.

Moving Light Controls

- 4 rotary Wheels with Pushbutton function.
- 1 Trackball 50 mm.

Power Requirements

- Power supply cable: CEE22 connector
- Power supply: 50/60 Hz, 100 - 240 V, 7 A - 3.5 A

Keypad

- Status information LCD.
- Channel selection: +, -, Thru, +%, -%, At Level, All and Invert commands.
- RECORD/UPDATE for Presets, Looks, Groups, and Palettes with filtered options.
- Direct Frame (Gel String Colour) key.
- Direct Numeric entry for SEQUENCE Times and Special.
- Times.
- Undo key.

Integrated 10.1" LED Touchscreen

5 Dedicated keys for very quick related content display:

- SEQUENCE
- SUBMASTERS
- CHANNELS
- MOVING LIGHTS CONTROL
- UNLIMITED USER SCREEN LAYOUTS



Memory Control Desks

Code	Description	Reference
1AM510010000	FREEDOM - 120 channels	FREEDOM/120
1AM520010000	FREEDOM - 240 channels	FREEDOM/240
1AM530010000	FREEDOM - 360 channels	FREEDOM/360
1AM540010000	FREEDOM - 512 channels	FREEDOM/512
1AM550010000	FREEDOM - 1024 channels	FREEDOM/1024
1AM560010000	FREEDOM - 2048 channels	FREEDOM/2048
	Basic desk featuring:	
	<ul style="list-style-type: none"> • 4 DMX universes on XLR5 • 1 DMX input on XLR5 • 32 DMX addressable universes through Ethernet (depends on deployed protocol) • Universal power supply 90-264 V, 50-60 Hz • 1 SVGA and 1DVI (or HDMI) Video Screen output • 1 Audio input • 1 Ethernet, on RJ45 • 1 keyboard port • 2 XLR3 for 12V "gooseneck" desk lamp 	
	Supplied with:	
	<ul style="list-style-type: none"> • Alphanumerical keyboard (qwerty/qwertz/azerty... to be specified at order) and mouse • Power Supply cable • Dust cover • Quick Start User Manual and System restore Media 	
	Hardware Options and Accessories	
1105.54.120	Additional block of 120 channels (retrofit for upgrade of 120 and 240 Channel Desks to next group)	120CH/UP/HAT
1105.54.512	Additional block of 512 channels (retrofit for 512 up to 1024 instruments)	512CH/UP/HAT
2810.02.050	MIDI – USB adaptor	MIDI/USB
2870.01.190	22" LCD/TFT monitor	LCD22
2870.01.201	24" LCD/TFT monitor with Multi Touch Integrated	LED24/HAT
1105.53.475	XLR3 "gooseneck" desk lamp	WORKLITE/XLR3
1105.51.020	Flight case for FREEDOM consoles	FLY/F
1105.51.010	Flight case for 24" Touchscreen Monitor	FLY/M/L
1AM410010000	Backup for FREEDOM 120	RPU/120
1AM420010000	Backup for FREEDOM 240	RPU/240
1AM430010000	Backup for FREEDOM 360	RPU/360
1AM440010000	Backup for FREEDOM 512	RPU/512
1AM450010000	Backup for FREEDOM 1024	RPU/1024
1AM460010000	Backup for FREEDOM 2048	RPU/2048
2810.00.110	Wireless Remote Control unit	WIFI/FULL/HAT
1AM700000000	24-Subfader Extension	SUB24/EXT/H
1145.12.402	External Power Supply	EPS/9
1145.12.400	Extension 1.50 m cable	DB15/15
1145.12.401	Extension cable kit (30 m / non assembled)	DB15/300

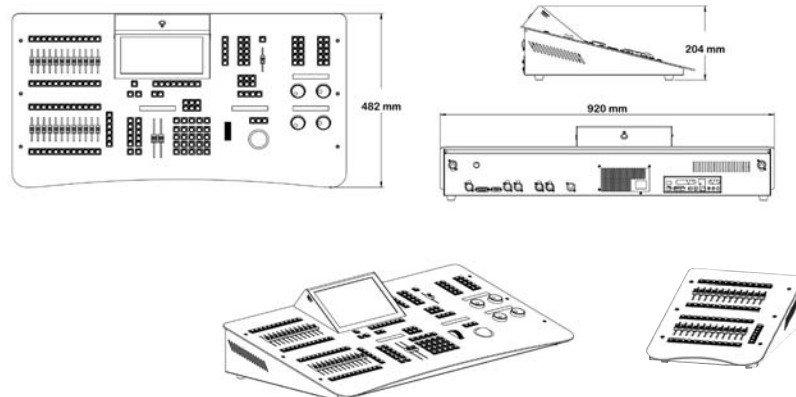

Controlling **LIBERTY**



LIBERTY is the spot-on solution for space-challenging environments and all venues seeking a fully integrated solution in a highly compact and portable package with the capacity of much larger and more expensive lighting consoles.

The control desk software (which is common with the FREEDOM console) itself has been developed with the requirements of modern lighting design in mind, including a new Moving Light library, with over 10000 fixtures. The lighting control desk philosophy has been specifically designed for theatre stage lighting without any compromise. As an operator it is easy to advance from a LIBERTY console to other members of the HATHOR software powered lighting control desk family thanks to the highly intuitive operating interface.

The heart of the unit is driven by a dual core processor with multiple graphical screens and running under the recent embedded version of Windows OS. This design offers unrivalled performance and reliability, as well as the flexibility to incorporate the software drivers for the latest peripheral devices. The lighting console exchanges among other protocols with standard ASCII show files. The operator may freely configure the screen layout and tailor the user interface to their personal needs and preferences.

LIBERTY is available in five basic configurations controlling channel numbering from 120 to 1024 multi-parameter lighting instruments and can address up to 16 universes via suitable networks. Synchronised passive backup feature is integrated in the system. LIBERTY consoles perform as standalone or as a backup/client desk in an extended network system. Networked LIBERTY and FREEDOM consoles will support multi-user / multi-operator setups with optional software packages.

LIBERTY comes with an SSD disk drive, which makes the console extremely silent and improves the boot-up time.

Playbacks

- 1 Grandmaster with Blackout key.
- 24 physical Submasters with assign key and Flash key.
- Modes: Solo / Inhibit / Focusing / Rubberband & Auto-execute look.
- Loading possibilities: Channels, Groups, Presets, Looks.
- Chasers, Attributes and Palettes.
- 1 Master Playback 100 mm (Sequential Theatrical Crossfade).
- GO / GO BACK / PAUSE / Jump / SEQ- & SEQ + keys.
- 1 Intensity / Speed control wheel.

Moving Light Controls

- 4 virtual touchscreen sliders located on the central 10.1" LED Touchscreen.

Power Requirements

- Power supply cable: CEE22 connector
- Power supply: 50/60 Hz, 100 - 240 V, 7 A - 3.5 A

Keypad

- Status information LCD.
- Channel selection: +, -, Thru, +%, -%, At Level, All and Invert commands.
- RECORD/UPDATE for Presets, Looks, Groups, and Palettes with filtered options.
- Direct Frame (Gel String Colour) key.
- Direct Numeric entry for SEQUENCE Times and Special.
- Times.
- Undo key.

Integrated 10.1" LED Touchscreen

5 Dedicated keys for very quick related content display:

- SEQUENCE
- SUBMASTERS
- CHANNELS
- MOVING LIGHTS CONTROL
- UNLIMITED USER SCREEN LAYOUTS

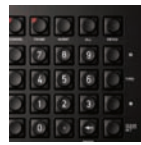

Memory Control Desks

Code	Description	Reference
1AM110010000	LIBERTY - 120 channels	LIBERTY/120
1AM120010000	LIBERTY - 240 channels	LIBERTY/240
1AM130010000	LIBERTY - 360 channels	LIBERTY/360
1AM140010000	LIBERTY - 512 channels	LIBERTY/512
1AM150010000	LIBERTY - 1024 channels	LIBERTY/1024
	Basic desk featuring:	
	<ul style="list-style-type: none"> • 2 DMX universes on XLR5 • 16 DMX addressable universes through Ethernet (depends on deployed protocol) • Universal power supply 90-264 V, 50-60 Hz • 1 SVGA and 1DVI (or HDMI) Video Screen output • 1 Audio input • 1 Ethernet, on RJ45 • 1 keyboard port • 1 XLR3 for 12V "gooseneck" desk lamp 	
	Supplied with:	
	<ul style="list-style-type: none"> • Alphanumerical keyboard (qwerty/qwertz/azerty... to be specified at order) and mouse • Power Supply cable • Dust cover • Quick Start User Manual and System restore Media 	
	Hardware Options and Accessories	
1105.54.120	Additional block of 120 channels (retrofit for upgrade of 120 and 240 Channel Desks to next group)	120CH/UP/HAT
1105.54.512	Additional block of 512 channels (retrofit for 512 up to 1024 instruments)	512CH/UP/HAT
2810.02.050	MIDI – USB adaptor	MIDI/USB
2870.01.190	22" LCD/TFT monitor	LCD22
2870.01.201	24" LCD/TFT monitor with Multi Touch Integrated	LED24/HAT
1105.53.475	XLR3 "gooseneck" desk lamp	WORKLITE/XLR3
1105.51.000	Flight case for LIBERTY consoles	FLY/L
1105.51.010	Flight case for 24" Touchscreen Monitor	FLY/M/L
1AM410010000	Backup for LIBERTY 120	RPU/120
1AM420010000	Backup for LIBERTY 240	RPU/240
1AM430010000	Backup for LIBERTY 360	RPU/360
1AM440010000	Backup for LIBERTY 512	RPU/512
1AM450010000	Backup for LIBERTY 1024	RPU/1024
2810.00.110	Wireless Remote Control unit	WIFI/FULL/HAT
1AM700000000	24-Subfader Extension	SUB24/EXT/H
1145.12.402	External Power Supply	EPS/9
1145.12.400	Extension 1.50 m cable	DB15/15
1145.12.401	Extension cable kit (30 m / non assembled)	DB15/300

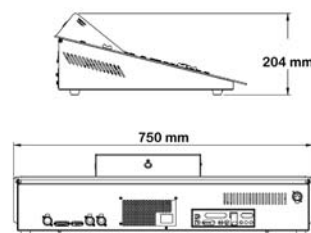
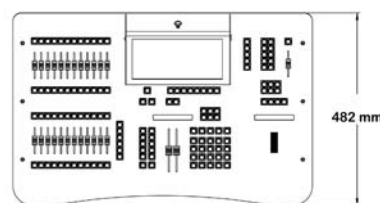



Following the success of ADB Lighting's LIBERTY and FREEDOM control desks, and to add an extra answer to customer's needs, ADB is expanding its HATHOR-technology based controller family with a brand new USB control surface: IMAGO.

IMAGO adds a compact and lightweight portable control surface to ADB's intuitive, powerful and state of the art lighting software, HATHOR.

Designed to answer the requirements of the company's growing customer base, IMAGO has been designed with cost, size and ergonomics in mind. Based on a keypad, a sequential crossfade and six subfaders, it offers all the essential elements and features of a fully-specified lighting controller, in a very compact format.

Because moving lights are central to most of today's productions, IMAGO comes with four push wheels and dedicated keys, allowing operators to efficiently control fixture parameters.

Combined with HATHOR lighting software and a simple USB connection between a laptop and the wing, IMAGO offers leading-edge capability, advanced features and enhanced programming, including two DMX outputs and one DMX input (for additional subfaders with any DMX console in the market), as well as the possibility to send 32 universes via Ethernet.

Applications

- Theatre / Opera / Television Studios
- Touring
- Schools and Cabarets

Playbacks

- 6 physicals Subfaders 60 mm with assign key Start key and Flash button. 6 Executor buttons (Assign key and Start key).
- Modes: Solo / Inhibit / Focusing / Rubberband & Auto-execute look.
- Loading possibilities: Channels, Groups, Presets, Looks, Chasers, Attributes and Palettes.
 - 1 Sequential Theatrical Crossfade.
 - 2 physicals faders 100 mm
 - GO / BACK / PAUSE / keys.
 - 1 Intensity / Speed control wheel.

Moving Light Controls

- 4 rotary Wheels with Pushbutton function.
- 7 Attribute Group/Palette keys.
- COPY ATT key.
- 8 Free assignable keys.

Keypad

- Channel selection: +, -, Thru, +%, -%, At Level, All and Invert commands.
- Direct Numeric entry for SEQUENCE Times and Special Times.
- RECORD/UPDATE for Presets, Looks, Groups, Palettes with filtered options.
- EDIT key
- FETCH key

Connections

- DMX Out: 2 DMX512 XLR 5 pins female.
- DMX In: 1 DMX512 XLR5 pin male.
- 2 USB Ports A.
- 1 USB Port B.
- 1 Desk Lamp supply.

Power Requirements

- External Power supply 12 V 500 mA

Physical Specifications

- Dimensions: 415 x 303 x 85 mm.
- Weight: 2.65 kg
- Four VESA mount screw-holes on the bottom panel.
- Kensington security slot on the rear panel.



USB Control Surfaces

Code	Description	Reference
1AM600000000	IMAGO	IMAGO
1AM610000000	IMAGO and HATHOR - 120 channels	IMAGO/120
1AM620000000	IMAGO and HATHOR - 240 channels	IMAGO/240
1AM630000000	IMAGO and HATHOR - 360 channels	IMAGO/360
1AM640000000	IMAGO and HATHOR - 512 channels	IMAGO/512
1AM650000000	IMAGO and HATHOR - 1024 channels	IMAGO/1024
1AM660000000	IMAGO and HATHOR - 2048 channels	IMAGO/2048
	IMAGO is supplied with:	
	<ul style="list-style-type: none"> • USB cable • 12 V power supply 	
	IMAGO and HATHOR is supplied with:	
	<ul style="list-style-type: none"> • IMAGO control surface, USB cable and power supply • USB Dongle (HATHOR License authorization) • USB memory stick • Quick Start User Manual and DVD 	
	NOTE: THERE IS NO COMPUTER INCLUDED IN THE PRODUCTS	
	HATHOR Software main features:	
	Channels	
	<ul style="list-style-type: none"> • 120/240/360/512/1024/2048 control channels (multi-parameter lighting instruments) such as LED fixtures, Moving Lights, Video Servers, Smoke Machines etc... (Retrofit upgrade of channel count possible by optional upgrade kits). • 1024 DMX outputs on 2 physical XLR5F connectors. • 32 Universes: 16384 outputs / parameters via Ethernet. Available Control Protocols: ARTNET, sACN, ART-RDM, Sandnet, Pathport, Shownet. 	
	Specifications	
	<ul style="list-style-type: none"> • 2000 Groups / 15000 Presets (cues) / 1000 Looks. • 1000 Sequences (Cue Lists) / 24 Playbacks. • 1000 Chasers. • 1000 Effect Templates. • 100 Dimmer Curves / 1000 Gel strings. • 14000 Palettes (2000 palettes/attribute group). • 7 basic Attribute Groups. • 100 instruments Layouts (topographic view of Channels). • 192 virtual Submasters (assignable in banks to physical faders). • 1000 Submasters Pages. • Virtuality unlimited screen's user layouts (stored to hard drive of control desk). • 100 panels. 	
	Hardware Options and Accessories	
1105.54.120	Additional block of 120 channels (retrofit for upgrade of 120 and 240 Channel Desks to next group)	120CH/UP/HAT
1105.54.512	Additional block of 512 channels (retrofit for 512, 1024 up to 2048 multi-parameter instruments)	512CH/UP/HAT
2870.01.190	22" LCD/TFT monitor	LCD22
2870.01.201	24" LCD/TFT monitor with Multi Touch Integrated	LED24/HAT
1105.53.476	XLR3 "gooseneck" desk lamp	WORKLITE/XLR3/IMAGO
2810.02.050	MIDI – USB adaptor	MIDI/USB
	MIDI cable	C.MIDI/M
2810.00.080	USB memory stick	FLASHMEM
	LAPTOP computer	LAPTOP/HAT
1105.51.010	Flight case for 24" Touchscreen Monitor	FLY/M/L

Controlling HATHOR Rack PC Unit



....The ideal companion for LIBERTY or FREEDOM RPU Software Features

New member of the HATHOR family the Rack PC Unit has been designed to be used either as backup with a LIBERTY or a FREEDOM, or as a stand-alone playback unit, in an architectural or themed spaces, context. This new compact 4U 19" housing solution can be easily integrated in control rooms and technical rooms.

Simply connect the RPU on your network, start your desk as "Master Ltd", then start your RPU as "Backup Ltd". The RPU will be 100% synchronised with the "Master" desk, following each step. Synchronised but not "active", this safety system avoids wrong uses. Anyway, when the "Master" fails, the RPU becomes "Master" and can be operated by using the keyboard and the mouse, an external Touch Screen, an X-Keys device or the 24 Subfader extension.

The heart of the unit is driven by a dual core processor supporting multiple graphical screens and running under the newest embedded version of Windows OS. This design offers unrivalled performance and reliability, as well as the flexibility to incorporate the software drivers for the latest peripheral devices. The operator may freely configure the screen layout and tailor the user interface to his personal needs and preferences.

The Rack PC Unit is available in six basic configurations controlling channel numbering from 120 to 2048 multi-parameter lighting instruments and can address up to 32 universes via suitable networks. The synchronised passive backup feature is integrated in the system.

APPLICATIONS

Theatre, architectural / museums, television, touring and rental, houses of worship, exhibitions, industrial event shows, cruise ships.

CONTROL CHANNELS

120/240/360/512/1024/2048 multi-parameter lighting instruments, LED fixtures, Moving Lights, Video Servers, Smoke Machines etc... (Retrofit upgrade of channel count possible by optional upgrade kits).

AVAILABLE CONTROL PROTOCOLS

ART-NET, Sandnet, Pathport, sACN, Shownet, SA Net, ETC Net2 and ART-RDM. A C N E1.31 ready.

OPERATIONAL FEATURES

- Graphical User interface with topographical views.
- Track Window allows editing of cues via Editor for parameters and intensities and tracking of all referenced objects such as Presets, Palettes, Groups and recorded Fader movements over the whole show.
- Drag'n drop facilities to copy/paste or move steps (cues) in the sequence.
- Each step (cue) can be edited Live or Blind, channel by channel and parameter by parameter, for values and crossfade times.

- 7 basic Palette Attribute Groups as: Focus, Color, Beam, Pattern, Extra, All, Dynamics.
- Reference Palettes and No reference Palettes.
- Palettes fully editable.
- Tracking mode for fixture's parameters with history background, editing and clean-up functions.
- Extensive Factory Template Library as well as user definable templates with 16 bit resolution for any parameter and intensities. Complete Template builder included, with direct access and live template modifications and check.
- Copy Attributes command to copy parameter's data from one luminaire to others of the same type.
- Fetch command to copy intensity and parameter's data from one cue in the list to stage for a selection of channels.
- Replace Fixture function to exchange one device for another one of different type.
- Play (show) browser allowing offline browsing and editing of shows not currently loaded.

SCREENS LAYOUTS

- Infinite possibilities to organize screens.
- Four sub-screens per monitor.
- Multiple windows per sub-screen.
- STORE and LOAD functions (User Layouts).
- Individual dynamic zoom of all editors and browsers.

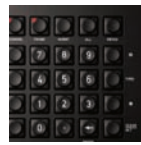

RPU

Code	Description	Reference
1AM410010000	RPU - 120 channels	RPU/120
1AM420010000	RPU - 240 channels	RPU/240
1AM430010000	RPU - 360 channels	RPU/360
1AM440010000	RPU - 512 channels	RPU/512
1AM450010000	RPU - 1024 channels	RPU/1024
1AM460010000	RPU - 2048 channels	RPU/2048

Supplied with:

- Alphanumerical keyboard (qwerty/qwertz/azerty... to be specified at order) and mouse,
- Supply cable,
- Quick Start user manual and system restore DVD.

Hardware Options and Accessories

For Channel upgrades please contact your ADB distribution Partner

2870.01.190	22" TFT monitor	LCD22
2870.01.201	24" TFT monitor with Multi Touch Integrated	LED24/HAT
2810.02.050	MIDI – USB adaptor	MIDI/USB
	MIDI cable C.MIDI/M	
2810.00.080	USB memory stick	FLASHMEM
	Flight case for RPU	FLY/RPU
1105.51.010	Flight case for 24" Touchscreen Monitor	FLY/M/L
1AM700000000	24-Subfader Extension	SUB24/EXT/H
1145.12.402	External Power Supply	EPS/9
1145.12.400	Extension 1.50 m cable	DB15/15
1145.12.401	Extension cable kit (30 m / non assembled)	DB15/300

RPU HARDWARE FEATURES

External Touchscreen

Up to two Standard Multi-touch Screens can be connected to the Rack PC Unit.

USB Devices

External USB devices such as X-Keys computer keypads and controllers are compatibles. Create a custom controller for your application with just the right layout and keys positioned exactly where you want them.

Physical Specifications

Dimensions (mm): 427 x 560 x 175

Weight Console (kg): 5

Operating temperature range: from + 5 °C – + 35 °C

Humidity: relative humidity not more than 95 % non-condensing.

Power Requirements

Power supply cable: GEE22 connector

Power supply: 50/60 Hz 100-240 V 7A-3.5 A

Physical INPUT/Output Connections

2 DMX512 XLR 5 pins female

1 ETHERNET RJ45

1 D-Sub connector – 8 external lines for remote triggering.

6 USB PORTS

2 USB located on front panel

1 AUDIO In XLR 3 pins female

1 DVI video connector

1 VGA video connector

1 PS2

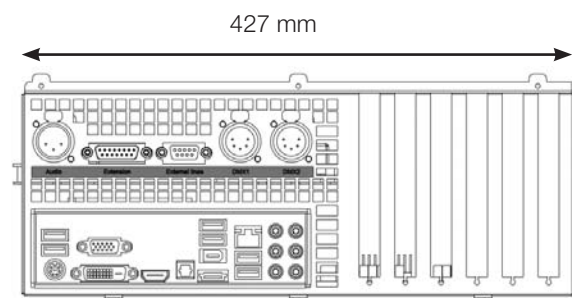
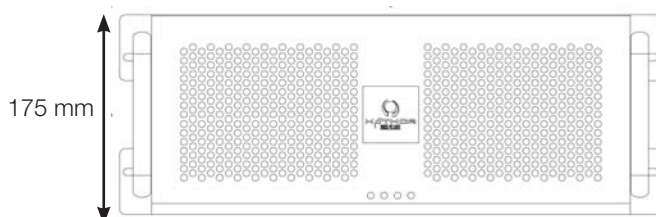

Controlling

DOMINO



DOMINO/XT 48/96

Main Features:

- 48 faders in 2-preset mode or 96 faders in extended mode on DOMINO/XT/96 - 24/48 faders on DOMINO/XT/48.
- 48 faders configurable as channels, submasters or playbacks on DOMINO/XT/96 - 24 faders on DOMINO/XT/48.
- 18 dedicated faders configurable in 9 pages as submasters or playbacks.
- 4 preset masters-A preset, B preset, C preset and grab.
- Theatrical dipless crossfade with 2 general masters, stage and preset, and dedicated buttons.
- Up to 594 memories on DOMINO/XT/96 - 378 on DOMINO/XT/48.
- Individual In (Up) and Out (Down) fade times.
- Up to 66 playbacks/chasers on DOMINO/XT/96 can be played simultaneously - 43 on DOMINO/XT/48.
- Fully proportional softpatch to 1024 dimmers.
- 2-preset, extended & memory modes, each fader with flash button.
- LED display showing status information via scrolling messages.
- Up to 250 steps of a chaser can be recorded as channels, or Memories/Snapshots.
- 1 SVGA output for displaying texts, memories, patch and help menus in multiple languages.
- 1 USB connector for show recording.
- MIDI IN/OUT connector (optional for DOMINO/XT/48 & 96).
- Moving light control module (optional on DOMINO/XT/48 and DOMINO/XT/96) and featuring:
 - Powerful effects engine and automatic fanning of fixtures.
 - Extensive fixture library with Web updates.
 - Comprehensive controls for filters, palettes, presets, cloning, groups, storing, lock home, etc.
 - 6 touch pad displays (virtual wheels) for parameter control.
 - DOMINO/XT/48/M: 36 groups, 96 presets, 96 pallets and 378 effects.
 - DOMINO/XT/96/M: 36 groups, 192 presets, 192 pallets and 594 effects.
- 2 DMX512/1990 output on XLR-5F connector.
- 90-260 V, 47/63Hz power supply with automatic detection.

DOMINO 24/48

Main Features:

- 24 faders in 2-preset mode or 48 faders in extended mode on DOMINO 48 - 12/24 faders on DOMINO 24.
- 24 faders configurable as channels, submasters or playbacks on DOMINO 48 - 12 faders on DOMINO 24.
- 3 preset masters: A preset, B preset and grab.
- Theatrical dipless crossfade with 2 general masters, stage and preset, and dedicated buttons.
- Up to 216 memories on DOMINO 48 - 108 on DOMINO 24.
- Individual In (Up) and Out (Down) fade times.
- Up to 25 playbacks/chasers on DOMINO 48 can be played simultaneously - 13 on DOMINO 24.
- Fully proportional softpatch to 512 dimmers.
- 2-preset, extended & memory modes, each fader with flash button.
- LED display showing status information via scrolling messages.
- Up to 250 steps of a chaser can be recorded as channels, or Memories/Snapshots.
- On DOMINO 24 U & 48 U as standard, and on DOMINO 24 & 48 as retrofit option:
 - 1 SVGA output for displaying memories, patch, texts and help menus in multiple languages
 - 1 USB connector for show recording
 - MIDI IN/OUT connector.
- 1 DMX512/1990 output on XLR-5F connector.
- 90-260 V, 47/63Hz power supply with automatic detection.



Manual and Memory Control Desks

Code	Description	Reference
5023.10.230	DOMINO/XT/48 - 48 channels - 1024 DMX addresses - 1 SVGA output	DOMINO/XT/48
5023.10.235	DOMINO/XT/48/M - 48 channels - 1024 DMX addresses - 1 SVGA output - Motion control module	DOMINO/XT/48M
5023.10.240	DOMINO/XT/96 - 96 channels - 1024 DMX addresses - 1 SVGA output	DOMINO/XT/96
5023.10.245	DOMINO/XT/96/M - 96 channels - 1024 DMX addresses - 1 SVGA output - Motion control module	DOMINO/XT/96M
Supplied with: power supply cable with CEE 7-7 plug		
Option		
5023.20.053	<ul style="list-style-type: none"> Moving light control module (for retrofit on DOMINO/XT/48 and DOMINO/XT/96), featuring: <ul style="list-style-type: none"> Powerful effects engine and automatic fanning of fixtures. Extensive fixture library with Web updates. Comprehensive controls for filters, palettes, presets, cloning, groups, storing, lock home, etc. 6 touch pad displayers (virtual wheels) for parameter control. Module added on DOMINO/XT/96: 36 groups, 96 presets, 96 pallets and 378 effects. Module added on DOMINO/XT/48: 36 groups, 192 presets, 192 pallets and 594 effects. 	MC/DOM/XT
Accessories		
2810.00.080	USB memory stick	FLASHMEM
1105.53.475	XLR3 "gooseneck" desk lamp	WORKLITE/XL3
1001.30.062	Dust cover for DOMINO/XT/48	DC/DOM/XT/48
1001.30.063	Dust cover for DOMINO/XT/96	DC/DOM/XT/96
5023.20.140	Flight case for DOMINO/XT/48	FLY/DOM/XT/48
5023.20.150	Flight case for DOMINO/XT/96	FLY/DOM/XT/96
Dimensions		
DOMINO 48 XT: 734 x 535 x 144 mm - Net weight: 15.5 kg		
DOMINO 96 XT: 974 x 535 x 144 mm - Net weight: 26.0 kg		
5023.10.210	DOMINO 24 - 24 channels - 512 DMX addresses	DOMINO/24
5023.10.215	DOMINO 24 U - 24 channels - 512 DMX addresses + USB option	DOMINO/24U
5023.10.220	DOMINO 48 - 48 channels - 512 DMX addresses	DOMINO/48
5023.10.225	DOMINO 48 U - 48 channels - 512 DMX addresses + USB option	DOMINO/48U
Supplied with: power supply cable with CEE 7-7 plug		
Option		
5023.20.034	USB option for retrofitting on DOMINO 24 & 48 and providing: <ul style="list-style-type: none"> 1 SVGA output for displaying memories, patch, texts and help menus in multiple languages 1 USB connector for show recording MIDI IN/OUT connector. 	USB/DOM
Accessories		
2810.00.080	USB memory stick	FLASHMEM
1105.53.475	XLR3 "gooseneck" desk lamp	WORKLITE/XL3
1001.30.060	Dust cover for DOMINO 24	DC/DOM24
1001.30.061	Dust cover for DOMINO 48	DC/DOM48
5023.20.120	Flight case for DOMINO 24	FLY/DOM24
5023.20.130	Flight case for DOMINO 48	FLY/DOM48
Dimensions		
DOMINO 24: 464 x 367 x 115 mm - Net weight: 7.5 kg		
DOMINO 48: 684 x 367 x 115 mm - Net weight: 10.5 kg		

Controlling

MIKADO



MIKADO 12/24

Main Features:

- 12 faders in 2-preset mode or 24 faders in extended mode, each with flash button and LED indicator.
- 3 pages of memories with 12 submaster faders per page = 36 memories.
- A submaster can be either a memory or a chaser and up to 13 memories/chasers can run simultaneously.
- 3 preset masters – A preset, B preset and grab.
- Add/Solo button with flash level master.
- Edit and preview of stored memories with channel level indicators.
- Manual and automatic dipless crossfade.
- Speed control of chasers.
- Chaser effects including Start/Stop/Step, random, bounce, single shot, forward/reverse direction, delete/add steps.
- Audio input with bass effect for chasers and audio level adjustment.
- External line input on 1/4" mono jack for remote control of chasers.
- 1DMX512/1990 output on XLR-5F connector.
- Internal power supply unit, input 230 V +/- 10% - 50/60 Hz.



Manual and Memory Control Desks

Code	Description	Reference
5023.10.200	<p>MİKADO</p> <p>Supplied with: power supply cable with CEE 7-7 plug</p> <p>Accessories</p>	MİKADO
5023.20.033	19" rack mount brackets	KIT/FIX/MIK/19
5023.20.032	External memory module, allowing recording of up to 4 show data	MEM/EXT/MIK
	<p>Dimensions</p> <p>MİKADO: 438 x 346 x 104 mm - Net weight: 5 kg</p>	

Networking

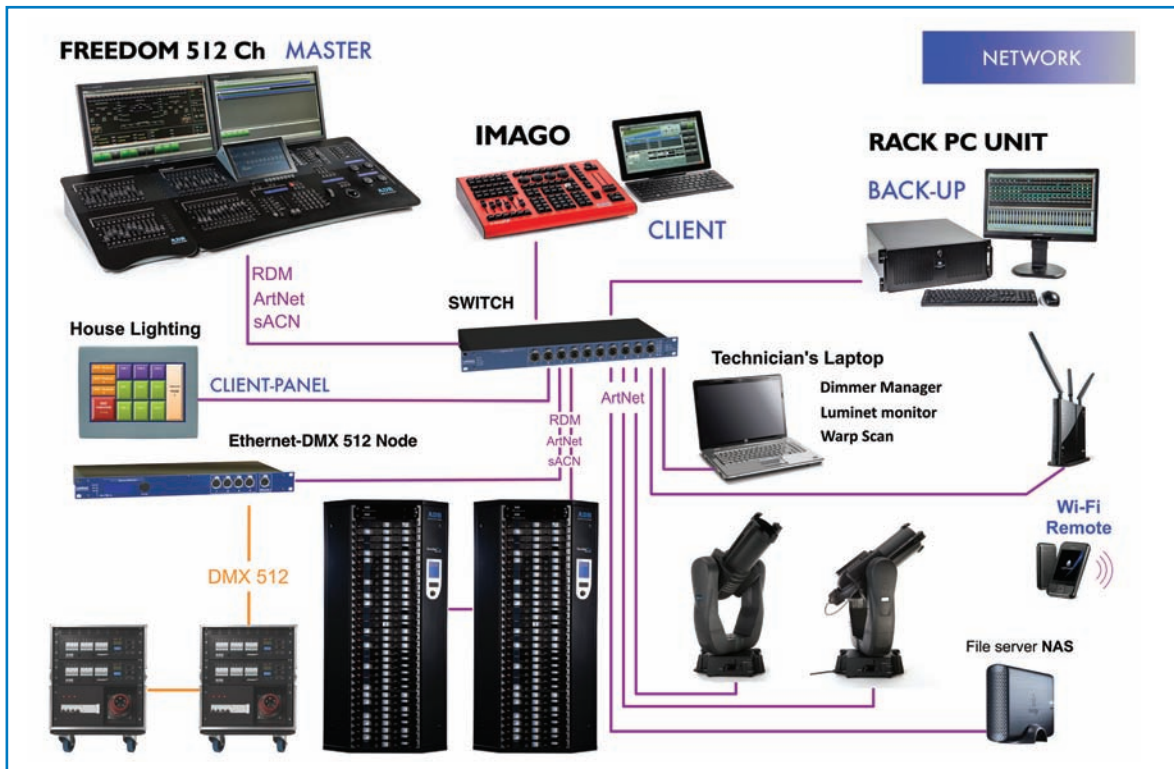

FREEDOM and LIBERTY control desks are ideal to work in a network configuration and may perform as stand alone or as back-up/client desks in an extended network system. A synchronised passive back-up feature is always integrated as standard in the system. Beyond that, networked LIBERTY and FREEDOM consoles support multi-user / multi-operator setups with either one of two optional software packages. One is designed for Networks with two desks (DUO) and another (MULTI) for networks with multiple desks. The lighting show information is completely updated instantaneously on line and different lighting desks operators can edit, run and manipulate a show all at the same time. This is a very powerful feature when large lighting installations have to be programmed swiftly and one operator would not be able to control all devices at the same time.

Above is an example of three desks working in Multi-User mode with some peripheral equipment connected to the system. Below are only some typical network products listed in this catalogue. Should you be interested in other configurations please contact our ADB Project Specialists who will advise on the most suitable solution for your own application.

SPLITTER

DMX512-A 2.10 Hub (DMX/SPLIT)

Distribute up to 2 DMX lines to 10 outputs. Bidirectional fully isolated RDM / DMX splitter, booster. 2 Input zones and 10 selectable outputs. All in 1 unit 19" rack space.



SWITCH

Ethernet Industrial Switch

The Switch is a Gigabit Ethernet switch designed to cope with the most demanding lighting and AV installations, including Multicast transmissions. Managed through a web interface, the device offers a user friendly experience with an industry specific oriented interface. It comes with a built-in redundancy system enabled on the fiber ports, providing a reliable and easy-to-set-up backbone for your network.



NODE

Ethernet-DMX2 (NODE / 19)

2 port DMX <-> Artnet node in a 19", 1 unit metal enclosure. Ideal for touring. DMX Input and/or output. Merging / backup / patching / routing.



Accessories and Software

When installing network systems, great care must be taken to the quality of cabling and connectors. If you are in doubt please contact ADB projects department for more information on the design of your project. We also recommend planning on-site commissioning by factory trained service technician.

Our partner LUMINEX offers, via its website, free of charge software tools to monitor and control lighting networks, and we recommend downloading from www.luminex.be



Networking

Code	Description	Reference
<p>Networking options for FREEDOM / LIBERTY desks</p>		
1105.51.100	Networking System Tracking Backup & active client for 2 Desks (DUO)	NET/DUO/HAT
1105.51.105	Networking Software Full Synchro for multiple Desks (MULTI)	NET/MULTI/HAT
	<p>If advanced Networking options are required one of the networking software licences must be procured per installation. For further information please contact your nearest ADB distribution partner or ADB directly.</p>	
1105.30.260	<p>DMX512 Splitter - DMX512-A 2.10 Hub</p> <p>Connections:</p> <ul style="list-style-type: none"> • 2 DMX512-A in/outputs on 5 pin male XLR, with termination (RDM compliant) • 10 DMX512-A in/outputs on 5 pin female XLR, with termination (RDM compliant) • Fixed mains lead (90-260 VAC, 47-63 Hz) 2 DMX512-A in/outputs on 5 pin male XLR on the back panel (identical to the 2 zone inputs on the front end) 	DMX/SPLIT
<p>Standard Ethernet Switch</p>		
1105.30.250	16 ports Ethernet Switch	NET/SWITCH/16P
	<p>Main features:</p> <ul style="list-style-type: none"> • Intelligent Fast Ethernet Switch • 19", 1 U metal housing • 10/100 Mbit • Internal power supply 	
1105.30.252	24 ports Ethernet Switch	NET/SWITCH/24
1105.30.253	48 ports Ethernet Switch	NET/SWITCH/48
	<p>Main features:</p> <ul style="list-style-type: none"> • 19", 1U metal housing • Stackable: 2 dedicated high-speed stacking ports providing 10 Gbps of bandwidth • 4 SFP ports • VLAN management • IGMP snooping 	
<p>Industrial Ethernet Switch</p>		
1105.30.254	12 ports Ethernet Switch	NET/SWITCH/12
	<p>Main features:</p> <ul style="list-style-type: none"> • 19", 1U metal housing • 10/100/1000 Mbit • 12 shielded Neutrik Ethercon connectors • IGMP snooping <p>Connections:</p> <p>12 x 10/100/1000Mbps Ethernet connections on Neutrik Ethercon connector (10 on the front , 2 at the rear).</p> <p>2 x SFP cages (Accept 100/1000Mbps compliant mini GBIC transceiver).</p> <p>Features:</p> <p>Wire-speed Layer 2 Switching Industry specific web interface RLinkX: activate redundancy on ports to create secured links</p> <p>Options:</p> <p>PoE supply unit: deliver up to 100 W through the 10 front Ethercon connectors, Backup PSU, Backup PoE supply unit, Group Licence, MultiLinkx Licence</p>	
5000.34.500	<p>Network Node - 19" Ethernet Converter Node</p> <p>Main features :</p> <ul style="list-style-type: none"> • Ethernet/Art-Net node for converting Art-Net into DMX512-A, or DMX512-A into ArtNet. • 2 outlets, compatible with DMX512-A, can be used as input or output 	NODE/19
	<p>Supplied with: power cable with plug</p>	

Dimming

Eurodim 
twin tech



One standard cabinet. No specific configuration of module places required. The cabinet fits all applications. Even if the final dimmer circuit layout has not been yet defined when you have to start installation, you can already order your cabinets. The system is future proof. You can "add-on" more circuits later. Just order additional dimmer modules, put them in the cabinet, and plug and play!

The EURODIM Twin Tech Cabinet features:

- 2 identical control electronics/power supply slots
- 32 power module slots for up to 128 channels
- Busbar with 32 HRC fuses for individual module protection
- Optimized airflow system separated from all cabling
- Output terminals for 10 mm² wiring (for other cable dimensions, contact ADB)
- I/O card with individual DMX and Ethernet connection (ArtNet, sACN, RDM) per Control Processor
- Local touch screen human interface for configuration

Absolutely free mixing of various module types in the same cabinet:

- Thyristor modules with min. 400 µs or 200 µs rise time
- DimSwitch modules
- True sine wave modules
- Fluo modules with additional preheat function
- Direct feed-through (non-dim) modules with MCB protection
- Blank modules

Electrical protection compliant with the highest international regulations:

- Standard MCB 1P+N protection per circuit
- Economical RCD per module protection
- RCD per circuit protection meets highest safety standards

Simple and efficient configuration per dimmer circuit

- 5 control inputs (2 x DMX512/3 x ArtNet-sACN) with priority level and priority rule
- 10 different dimmer laws available (6 user- configurable)
- Response time
- Preheat function

Advanced Interface and Control Features:

- 80 cues + 1 priority cue for individual programming
- Individual failure rule per circuit in case of data loss (hold, fade to black or fade to cue)
- System wide configuration and diagnostic status reporting with network PC

State-of-the-Art Diagnostic and Reporting Functions

Dimmer reporting, diagnostics and management are available either on the local user interface of the dimmer cabinet, via our optional ADB dimmer management software: TT Manager, or through RDM over ArtNet.

TT Manager and HATHOR lighting software allow for comfortable and easy system wide configuration and diagnostic status reporting with a networked PC running on a Windows Operating System or within LIBERTY and FREEDOM, (OS and suitable PC are not supplied by ADB).

Cabinet status with:

- Up to 300 LED indicators for status information of power supply and data
- Clear text messages on human interface indicating e.g. missing supply phase, loss of control signals, CPU failure, fan failure, ambient over temperature

Sequential diagnostics *(optional hardware to be separately ordered-TT Manager only)*

The sequential diagnostics is a pre-show test routine for circuit status reporting and is available with all standard modules.

- Value of dimmer load (kW)
- Deviation from a reference load
- No load and overload warning
- Short circuit

Full diagnostic modules *(optional, exclusively with suitable full diagnostic modules)*

- Dimmer protection tripped warning
- Overload and no-load warning
- Thyristor defect warning
- Load changes and comparison with stored reference value *(TT Manager only)*



Hybrid Dimming System with plug-in thyristor and/or sine wave modules

Code	Description	Reference
1DY422000000	Universal cabinet <ul style="list-style-type: none"> Power supply: <ul style="list-style-type: none"> Star 3 NPE 400 (TN-S), 198 V to 264 V, 50/60 Hz. Rated current 600 A Individual module protection by an HRC supply fuse (50kA) 63A Set of 4 Lifting eye bolts included Central electronics : <ul style="list-style-type: none"> Two slots for hosting 2 TT control units (CTRL) or 1 TT control unit (CTRL) + 1 backup power supply unit (PSU) Control signals: <ul style="list-style-type: none"> I/O board with: <ul style="list-style-type: none"> 4 DMX IN/THROUGH on screw terminals and RJ45 connector 2 Ethernet on RJ45 connector Remote CPU selection on screw terminals Space for up to 32 plug-in dimmer modules <ul style="list-style-type: none"> 4 x 3 kW thyristors; up to 128 x 3 kW per cabinet 4 x 2.5 kW sine wave; up to 128 x 2.5 kW per cabinet 3 x 5 kW thyristors; up to 96 x 5 kW per cabinet 3 x 5 kW sine wave; up to 96 x 5 kW per cabinet 1 x 10 kW upon request Free mix of sine wave, thyristor and DimSwitch modules Free mix of different dimmer ratings User-friendly human interface with backlit LCD touch-screen, 10 hard keys and control wheel Separate compartments for power supply and output cabling with easy front access. 	TTD/CAB/32
1115.10.100	Plug-in central control electronics <ul style="list-style-type: none"> LED indicators for power supply phases, data input and alarm messages. 5 control inputs with free DMX addressing (patch) and flexible merge rules per dimmer. Protocols: DMX512-A, Art-Net (Art-DMX), ACN and RDM ready. Internal power supply. Software functions described in the datasheet. 	TTD/CPU
1115.10.110	Plug-in back-up power supply unit Mandatory in combination with single TT control unit.	TTD/PSU
	Options	
1115.10.055	Human interface unit (mandatory) (must be ordered separately for each TTD cabinet)	TTD/IHM
1113.33.010	Power module lock	TTD/CAB/LOCK
1113.33.020	Cabinet junction plate (set of 2)	TTD/CAB/JP
1113.33.030	Sequential Diagnostics kit (optional hardware kit)	TTD/SEQD
1109.00.140	TT Management software (optional software)	TTD/DM/SOFT
1113.33.040	Noise reduction for TTD cabinet	TTD/CAB/NR
	Dimensions EURODIM Twin Tech: 1999 x 990 x 596 mm - Net weight: 229 kg Net weight plug-in modules: 12 kg +/- 10% depending on module type	

Code	Description	Reference
Sine Wave Dimmer Modules		
1120.26.634	4 x 2.5 kW module with full diagnostic MCB/1P+N +RCD (30mA) protection per dimmer	TTD/SD4 x 2.5/MN/4R
1120.26.672	3 x 5 kW module with full diagnostic MCB/1P+N + RCD (30mA) protection per dimmer	TTD/SD3 x 5/MN/3R
DimSwitch Thyristor Modules with 400 μs Rise Time in Dim Mode		
4 x 3 kW DimSwitch module with full diagnostic		
1125.27.050	MCB/1P+N protection per dimmer	TTD/HD4 x 3/MN/GE
1125.27.060	MCB/1P+N protection per dimmer + RCD (30mA) per DimSwitch module	TTD/HD4 x 3/MN/1R/GE
1125.27.020	MCB/1P+N + RCD (30mA) protection per dimmer	TTD/HD4 x 3/MN/4R/GE
3 x 5 kW DimSwitch module with full diagnostic		
1125.27.070	MCB/1P+N protection per dimmer	TTD/HD3 x 5/MN/GE
1125.27.080	MCB/1P+N protection per dimmer + RCD (30mA) per DimSwitch module	TTD/HD3 x 5/MN/1R/GE
1125.27.030	MCB/1P+N + RCD (30mA) protection per dimmer	TTD/HD3 x 5/MN/3R/GE
1 x 10 kW DimSwitch module with full diagnostic		
1125.27.040	MCB/1P+N + RCD (30mA) protection per dimmer	TTD/HD1 x 10/MN/1R/GE
4 x 3 kW DimSwitch module with standard diagnostic		
1125.27.250	MCB/1P+N protection per dimmer	TTD/H4 x 3/MN/GE
1125.27.260	MCB/1P+N protection per dimmer + RCD (30mA) per DimSwitch module	TTD/H4 x 3/MN/1R/GE
1125.27.220	MCB/1P+N + RCD (30mA) protection per dimmer	TTD/H4 x 3/MN/4R/GE
3 x 5 kW DimSwitch module with standard diagnostic		
1125.27.270	MCB/1P+N protection per dimmer	TTD/H3 x 5/MN/GE
1125.27.280	MCB/1P+N protection per dimmer + (30mA) per DimSwitch module	TTD/H3 x 5/MN/1R/GE
1125.27.230	MCB/1P+N + RCD (30mA) protection per dimmer	TTD/H3 x 5/MN/3R/GE
1 x 10 kW DimSwitch module with standard diagnostic		
1125.27.240	MCB/1P+N + RCD (30mA) protection	TTD/H1 x 10/MN/1R/GE
DimSwitch Thyristor Modules with 200 μs Rise Time in Dim Mode		
4 x 3 kW DimSwitch module with full diagnostic		
1125.26.304	MCB/1P+N protection per dimmer	TTD/RD4 x 3/MN/GE
1125.26.324	MCB/1P+N protection per dimmer + RCD (30mA) per DimSwitch module	TTD/RD4 x 3/MN/1R/GE
1125.26.344	MCB/1P+N + RCD (30mA) protection per dimmer	TTD/RD4 x 3/MN/4R/GE
3 x 5 kW DimSwitch module with full diagnostic		
1125.26.354	MCB/1P+N protection per dimmer	TTD/RD3 x 5/MN/GE
1125.26.376	MCB/1P+N protection per dimmer + RCD (30mA) per DimSwitch module	TTD/RD3 x 5/MN/1R/GE
1125.26.383	MCB/1P+N + RCD (30mA) protection per dimmer	TTD/RD3 x 5/MN/3R/GE
4 x 3 kW DimSwitch module with standard diagnostic		
1125.26.004	MCB/1P+N protection per dimmer	TTD/R4 x 3/MN/GE
1125.26.024	MCB/1P+N protection per dimmer + RCD (30mA) per DimSwitch module	TTD/R4 x 3/MN/1R/GE
1125.26.044	MCB/1P+N + RCD (30mA) protection per dimmer	TTD/R4 x 3/MN/4R/GE
3 x 5 kW DimSwitch module with standard diagnostic		
1125.26.054	MCB/1P+N protection per dimmer	TTD/R3 x 5/MN/GE
1125.26.076	MCB/1P+N protection per dimmer + RCD (30mA) per DimSwitch module	TTD/R3 x 5/MN/1R/GE
1125.26.083	MCB/1P+N + RCD (30mA) protection per dimmer	TTD/R3 x 5/MN/3R/GE



Plug-in Digital Dimmer Modules

Code	Description	Reference
<p>Thyristor Dimmer Modules for Fluorescent Lamps with 200 μs Rise Time</p>		
1125.26.316	<p>2 x 3 kW module with full diagnostic MCB/1P+N + RCD (30mA) protection per dimmer</p>	TTD/FD2 x 3/MN/2R/GE
1125.26.016	<p>2 x 3 kW module with standard diagnostic MCB/1P+N + RCD (30mA) protection per dimmer</p>	TTD/F2 x 3/MN/2R/GE
<p>Direct Feed-through (non-dim) Modules with no Remote Control</p>		
1125.26.241	<p>4 x 3 kW module with standard diagnostic MCB/1P+N + RCD (30mA) protection per dimmer</p>	TTD/N4 x 3/MN/4R/GE
1125.26.281	<p>3 x 5 kW module with standard diagnostic MCB/1P+N + RCD (30mA) protection per dimmer</p>	TTD/N3 x 5/MN/3R/GE
<p>Accessories</p>		
1120.26.291	Blank panel for 1 slot	TTD/TB
1120.26.292	Blank panel for 8 slots	TTD/TB/8

DimSwitch Module



The DimSwitch feature, a lot of benefits:

- Each dimmer circuit shall be capable to be set as a "dimmer" for generic lighting or to be set as a "Solid State Relay".
- Solid State Relay mode allows to connect any other load such as HMI ballast or DMX instrument such as LED fixtures, Fluorescent lights, moving heads.
- No minimum load required.

DimSwitch function allows saving in the electrical wiring and to have only ONE identified electrical distribution network for all Dimmed and Switched circuits.

Whom are ALL controlled with the DMX512.

Dimming

EURORACK 60 DIMSWITCH



EURORACK 60 DIMSWITCH

High Performance Thyristor Dimmer Racks for Professional Applications, including DimSwitch function

Standard configurations:

- 24 x 3 kW
- 12 x 5 kW

Designed for professional applications in stage, TV studio and architectural lighting, whenever high performance, flexibility and reliability are the prime considerations, the new EURORACK 60 DIMSWITCH offers not only the dimming of generic lighting, but also the electronic switching of any special load such as HMI ballasts or electronic equipment. A choice of various RCD ground fault detection systems is available to comply with various safety standards.

The versatility of ADB wall mount dimmers makes them suitable for virtually any venue - from schools and churches, to theatres, clubs and even larger professional venues, whenever a permanent lighting system is required.

Wall mount dimmers with their local memories, provide also an integrated solution for architectural applications such as conference rooms, reception areas, exterior lighting, sound-and-light shows. Local memories and DMX control can be combined, so that a EURORACK 60 DIMSWITCH can be shared between the stage and the foyer, or the houselights.

Set-up and User Interface Functionality

- 5-key keypad, 12-character LED display and user-friendly scrolling menu for easy access to all dimmer functions.
- Menu with different levels of access for different levels of users, protected against tampering.
- 10 user-selectable dimmer laws: linear r.m.s voltage, linear r.m.s to 120 V, TV laws (BBC, TV1, TV2), DimSwitch, fluorescent, linear r.m.s voltage with preheating, square law.
- Voltage reduction factor for extended lamp life or variable load cable length compensation.
- Professional grade filtering (200 μ s rise time).
- 4000-step fade resolution, for noticeably smoother fades.
- Global or individual programming of dimmer law, patching, voltage reduction factor and smoothing.
- Creation and storage of 20 lighting cues (19 + Priority) each with fade and wait times, for back-up cues, architectural lighting, or stand-alone operation.
- Memories set by recording DMX levels or via the menu.
- After loss of DMX data: maintain last levels, or wait and fade to a memory or wait and fade to black.
- All programmed data saved for unlimited time.
- New DimSwitch technology, allowing control of circuit function: either dimming or real Solid State Relay, with all the advantages of electronic switching.



Wall Mount Dimmer Racks

Code	Description	Reference
EURORACK 60 DIMSWITCH		
High performance thyristor dimming with 200 µs rise time		
1DF602100002	24 x 3 kW - MCB/1P+N	ERACK 60/243MN/GE/DS
1DF702100002	12 x 5 kW - MCB/1P+N	ERACK 60/125MN/GE/DS
Dimensions		
EURORACK 60 DIMSWITCH: 1022 x 555 x 132 mm		
Net weight: 43 kg		
Options		
	RCD - 30 mA (1P+N)	RCD30/ERACK
	Supply protection per group of 30 kW (12 x 3 kW or 6 x 5 kW)	
	Required quantity: 2 per EURORACK 60 DIMSWITCH	
	RCD+MCB/1P+N-30mA - 6kA per dimmer	
	- for 24 x 3 kW dimmers	RCD+MCB/243
	- for 12 x 5 kW dimmers	RCD+MCB/125
	Main isolator switch 4P - 100 A	INP.SWITCH/ERACK
	Analogue input interface for architectural applications	KIT/ANA/24
	Star/Delta power supply upon request	
Accessories		
1113.31.400	Stand-off brackets for 10 cm trunking space behind the rack (kit)	ARC/ERACK
1113.99.120	Dual DMX input retrofit kit (CPU board with data cables)	KIT/2DMX/ERACK
1113.32.300	Cable entry panel with 27 universal entry seals and a steel PG31 cable gland + additional cable support rails (supplied as retrofit kit)	PANN.PG/ERACK

The DimSwitch feature, a lot of benefits:

- Each dimmer circuit shall be capable to be set as a "dimmer" for generic lighting or to be set as a "Solid State Relay".
- Solid State Relay mode allows to connect any other load such as HMI ballast or DMX instrument such as LED fixtures, Fluorescent lights, moving heads.
- No minimum load required.

DimSwitch function allows saving in the electrical wiring and to have only ONE identified electrical distribution network for all Dimmed and Switched circuits.

Whom are ALL controlled with the DMX512.

Dimming

MEMORACK

MEMORACK 30 - 19" Rack Mount Dimmer unit 30 kW

Intelligent, all-digital dimmer racks for 19" rack mounting in two configurations; 12 x 3 kW or 6 x 5 kW.

The dimmers are suitable for continuous duty (3 kW or 5 kW per channel) at 35° C up to 30 kW.



MEMORACK 15 - 19" Rack Mount Dimmer unit 15 kW

Intelligent, all-digital dimmer racks for 19" rack mounting in two configurations: 6 x 3 kW or 3 x 5 kW.

The dimmers are suitable for continuous duty (3 kW or 5 kW per channel) at 35° C up to 15 kW.



This Rack & Pack Mount Dimmer is designed for professional applications in stage, TV studio and architectural lighting, whenever high performance, quality, endurance and reliability are the prime considerations. Ideal for touring, decentralised dimming or extension of existing installations. They are available with lockable standard Harting, socapex, or Cebec, Schuko or CEE compatible sockets.

This dimmer feature professional grade filtering of 200 μ s for efficient attenuation of lamp filament noise. The circuitry is protected against accidental 400 V wiring. Hard fired thyristors are used exclusively for control of tungsten halogen lamps, resistive and inductive loads as well as transformer-fed low voltage lamps, and fluorescent lighting with suitable ballast.

Low noise fans provide effective cooling and are fitted with automatic fan-stop. Over-temperature protection through gradual dimmer fade out.

This dimmer is designed for a power supply 230V/400V Star 3NPE (TN-S Net), 50/60Hz. Each dimmer circuit is protected individually by a 1 Pole + Neutral disconnect Magnetic Circuit Breaker (MCB). The dimmers are suitable for continuous duty (3 kW or 5 kW per channel) at 35° C up to 15 or 30 kW. The dimmers are controlled by a standard DMX512/1990 signal on front mounted XLR-5 male connector and a XLR-5 female connector for signal feed through.

Programming and Set-up Functions

- 5-key keypad, 12 character LED display and user friendly menu for easy access to all dimmer functions.
- Set-up functions can be limited to "DMX start address".
- Local controls for creation and storage of 20 lighting cues.
- Individual selection of dimmer address (patch), law, smoothing and voltage reduction factor.
- Fade smoothing (4000-step resolution).
- 10 dimmer laws (one is user-programmable).
- Professional grade filtering (200 μ s rise time).
- Local status reporting: 400 V - overtemperature - fan failure - processor check - presence of DMX signal - DMX and analogue control levels.
- Local test of a dimmer (steady, flash or chaser).
- Automatic self-test capability.
- Programmable response to a DMX failure.



Intelligent Dimmer Packs for Professional Applications

Code	Description	Reference
------	-------------	-----------

MEMORACK 30

1DA16D100004	12 x 3 kW - MCB/1P+N - 2 x HARTING HAN16E out	M30/123MN/HAR
1DA162100004	12 x 3 kW - MCB/1P+N - 2 x SOCAPEX 419 out	M30/123MN/SOC
1DA2DE100004	6 x 5 kW - MCB/1P+N - 2 x HARTING HAN HsB 6+PE out	M30/65MN/HAR

Dimensions: 456 x 444 x 132 mm - Net weight: 20 kg

Notes:

- Power supply cable 1.5 m - 5 x 10 mm², no connector attached.
- Front panel DMX input on XLR5.
- Comes with kit for installation in a 19" touring rack and 4 rubber feet.
- Other electrical protection on request.

MEMORACK 15

1DD206120004	6 x 3 kW - MCB/1P+N - 6 x twin Cebec sockets	M15/63MN/C
1DD206220004	6 x 3 kW - MCB/1P+N - 6 x twin Schuko sockets	M15/63MN/D
1DE204120004	3 x 5 kW - MCB/1P+N - 3 x CEE17 32A sockets	M15/35MN/CEE

Dimensions: 456 x 444 x 132 mm - Net weight: 17 kg

Notes:

- Power supply cable 1.5 m - 5 - 4 mm², no connector attached.
- Front panel DMX input on XLR5.
- Comes with kit for installation in a 19" touring rack and 4 rubber feet.
- Other electrical protection on request.

Accessories

Carrying handle for MEMORACK 15 and 30	PORT/M30
Hanging kit - delivered without hook - hole Ø 10.5 mm	SUSP/M30
Set of 2 whips HAR/6 CEE17 16A - 1 m length for M30/123MN/HAR	KIT/HAR/6CEE
Set of 2 whips HAR/6 PC double NF 10/16 - 1 m length for M30/123MN/HAR	KIT/HAR/6PCNF
Set of 2 whips HAR/3 PC CEE17 32A - 1 m length for M30/65MN/HAR	KIT/HAR/3CEE

Standard Outlet Panels (other outlets upon request)



M30/123MN/HAR



M15/63MN/C



M30/123MN/SOC



M15/35MN/CEE



M30/65MN/HAR

Dimming

MIKAPACK

MIKAPACK 30 - 12 x 3 kW

Intelligent, all-digital dimmer packs as portable units or for 19" rack mounting.

The dimmers are suitable for continuous duty of 12 channels of 3 kW at 35° C up to 30 kW.

For architectural applications, a DB9 connection allows to easily recall 4 internal pre-programmed dimmer memories via dry contacts.



MIKAPACK 15 - 6 x 3 kW

Intelligent, all-digital dimmer packs as portable units or for 19" rack mounting.

The dimmers are suitable for continuous duty of 6 channels of 3 kW at 35° C up to 15 kW.



MIKAPACK dimmers feature similar performances to the MEMO dimmer range at a very competitive price without concessions to quality and reliability. The products are designed for decentralised dimming in fixed installations, touring, stage, TV studio and architectural lighting.

MIKAPACK dimmers are available with all standard European outlets and, for permanent installation or flight case applications, with screw-on terminal strip.

An optional carrying handle is available for portable units. The units are shipped with the necessary parts for installation in 19" racks.

Common features of the range are:

- 4 control buttons, 2 x 8 character LCD display and user-friendly menu for easy access to all dimmer functions.
- First dimmer address selection.
- Local test of a dimmer (steady or chaser).
- 6 pre-programmed chasers with 6 intensity levels.
- Patch selectable per dimmer.
- 9 dimmer laws selectable per dimmer + 1 user programmable law.
- Preheat selectable per dimmer.
- Maximum dimmer levels selectable per dimmer.
- Storage of 16 lighting cues.
- Last lighting cue maintained in case of DMX signal interruption or loss. (cue, last DMX values or fading out).
- Return to factory default values.
- User customization of menu items.

Technical Specifications

- Power supply: 230 V / 400 V Star 3NPE, 50/60 Hz.
- Dimmer protection with MCB's, 1P+N.
- Suitable for continuous duty at 35° C.
- 40 A power semiconductors.
- Control protocol: DMX512A on XLR5, with galvanic isolation.



Intelligent Dimmer Packs for General Purpose Applications

Code	Description	Reference
MIKAPACK 30		
5021.03.200	12 x 3 kW - MCB / 1P+N - 12 x single NF/CEBEC sockets	MIK30/123MN/C
5021.03.210	12 x 3 kW - MCB / 1P+N - 12 x single Schuko sockets	MIK30/123MN/D
5021.03.220	12 x 3 kW - MCB / 1P+N - Screw-on terminal strip	MIK30/123MN
5021.03.230	12 x 3 kW - MCB / 1P+N - 12 x single CEE 16 A (P17) sockets	MIK30/123MN/CEE
5021.03.240	12 x 3 kW - MCB / 1P+N - 12 x single Swiss sockets	MIK30/123MN/H
5021.03.250	12 x 3 kW - MCB / 1P+N - 12 x single UK 15 A sockets	MIK30/123MN/UK
5021.03.260	12 x 3 kW - MCB / 1P+N - 2 x SOCAPEX connector	MIK30/123MN/SOC
5021.03.270	12 x 3 kW - MCB / 1P+N - 2 x Harting Output	MIK30/123MN/HART
Dimensions: 440 x 355 x 132 mm - Net weight: 15 kg		
Notes:		
<ul style="list-style-type: none"> • Power supply cable 1.5 m - 5 x 10 mm² no connector attached • Front panel DB9 connection for memory recall • Front panel DMX input on XLR5 • Front brackets for 19" rack mounting • 1P+N protection by MCB per channel • 4 rubber feet • Kit for installation in a 19" touring rack 		
MIKAPACK 15		
5021.03.000	6 x 3 kW - MCB / 1P+N - 6 x single NF/CEBEC sockets	MIK15/63MN/C
5021.03.010	6 x 3 kW - MCB / 1P+N - 6 x single Schuko sockets	MIK15/63MN/D
5021.03.020	6 x 3 kW - MCB / 1P+N - Screw-on terminal strip	MIK15/63MN
5021.03.030	6 x 3 kW - MCB / 1P+N - 6 x single CEE 16 A (P17) sockets	MIK15/63MN/CEE
5021.03.040	6 x 3 kW - MCB / 1P+N - 6 x single Swiss sockets	MIK15/63MN/H
5021.03.050	6 x 3 kW - MCB / 1P+N - 6 x single UK 15 A sockets	MIK15/63MN/UK
Dimensions: 440 x 355 x 88 mm - Net weight: 10.3 kg		
Notes:		
<ul style="list-style-type: none"> • Power supply cable 1.5 m - 5 x 4 mm² no connector attached • Exception for MIK15/63M only connection on 3-phase terminal strip • Front panel DMX input on XLR5 • Front brackets for 19" rack mounting • 1P+N protection by MCB per channel • 4 rubber feet • Kit for installation in a 19" touring rack 		
Options and Accessories		
5021.03.100	Carrying handle for MIKAPACK 15	PORT/MIK15
5021.03.130	Truss clamping kit for MIKAPACK 15	KIT/CLAMP/MIK15
5021.03.150	Carrying handle for MIKAPACK 30	PORT/MIK30

Standard Outlet Panels (other outlets upon request)

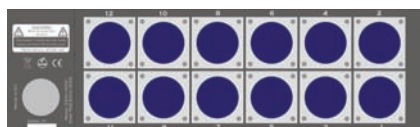

12 x CEE 16 A (P17)



12 x NF/CEBEC or 12 x Schuko

Dimming

Touring Racks



The best Dimmers may well not be those you are used to...

MEMORACK and MIKAPACK dimmer modules can also be factory installed in suitable flight cases for touring applications. The dimmers are all 1 pole protected with neutral disconnect and the individual dimmer rack power supply is protected against any ground fault by an RCD. This makes the dimmers safe and compliant with highest industry standards and international regulations.

Standard ADB touring racks are available in 24-channel or 12-channel configurations with European outlets (Schuko, NF/CEBEC, CEE16 and/or multiconnectors: Harting, Socapex-compatible) without top patch. The dimmers, 19" panels and other hardware are mounted on a self-supporting welded steel frame (19U) and fitted with heavy-duty casters for easy transport. Flight case is fitted with removable covers for front and rear access.

Local Control without Lighting Desk:

- Flashing of one dimmer for easy luminaire identification in a rig
- Chaser
- Setting of a dimmer level
- Creation, editing and play-back of lighting cues depending on the dimmer range selected.
- "Panic" cue which always overrides DMX

Custom Versions

ADB touring racks can be built to order with a custom combination of standard building blocks with a wide choice of patch panels, direct outputs, RCD protections, multiconnectors, and accessories.

Custom versions are available upon request; please contact your ADB Distribution Partner or ADB Sales directly.



Flight Case Dimmers for Touring

Code	Description	Reference
Flight Case Dimmer Systems		
1001.40.201	Flight case equipped with MIKAPACK 30 - 24 x 3 kW - 24 x twin CEBEC 10 / 16 A sockets	FCMIK243MN/C
1001.40.202	Flight case equipped with MIKAPACK 30 - 24 x 3 kW - 24 x twin schuko 10 / 16 A sockets	FCMIK243MN/D
1001.40.203	Flight case equipped with MIKAPACK 30 - 24 x 3 kW - 24 x single CEE 16 A (P17) sockets	FCMIK243MN/CEE
1001.40.204	Flight case equipped with MEMORACK 30 - 24 x 3 kW - 24 x twin CEBEC 10 / 16 A sockets	FCMR243MN/NC
1001.40.205	Flight case equipped with MEMORACK 30 - 24 x 3 kW - 24 x twin schuko 10 / 16 A sockets	FCMR243MN/D
1001.40.206	Flight case equipped with MEMORACK 30 - 24 x 3 kW - 24 x single CEE 16 A (P17) sockets	FCMR243MN/CEE
1001.40.207	Flight case equipped with MEMORACK 30 - 12 x 5 kW - 12 x single CEE 32 A sockets	FCMR125MN/CEE
<p>Other configurations (connectors) and systems are available upon request. These are some standard examples. Please contact your ADB sales partner for further information.</p> <p>Common Features: Flightcase 12 U high, equipped either with two MIKAPACK 30 or two MEMORACK 30 dimmers. Flightcase is on 4 casters.</p> <ul style="list-style-type: none"> • detachable front and back lid for flightcase • 125 A 5 pole CEE connector • RCD and MCB 3P+N disconnect • individual channels protected with 1P+N MCB • control via DMX512 <p>Dimensions: 820 x 550 x 725 mm</p> <p>Options and Accessories</p>		
40081	Kit Harting 4 connectors - instead of individual sockets	FCHRAR4
40080	Kit Harting 4 connectors - parallel connection to existing sockets	FCHAR4.BRA
40082	Kit Socapex 4 connectors - instead of individual sockets	FCSOC4
40083	Kit Socapex 4 connectors - parallel connection to existing sockets	FCSOC4.BRA
40084	Kit Work Light	FCLIGHT
32086	Power supply cable - (Legrand) HYPRA PA+FG	FCMOB.LEG
32135	Power supply cable - 3P+N+PE (Marechal) PA+FG	FCMOB.MAR
40085	Replacement of connector Legrand with a connector Marechal	FCLEGMAR

Lighting - Theatre Spotlights

MOTORIZED WARP

WARP/M

& WARP/M Daylight

The only fully automated Zoom Profile totally noiseless



WARP/M - Motorized Zoom Profile Spotlight

Main Features:

- 12° - 30° and 22° - 50° versions
- 800 W halogen axial lamp, 230 V, 3200 °K, G9.5
- Light output higher than with a 1200 W conventional profile
- Dichroic glass reflector for low gate and beam temperature
- B size gate for maximum gobo definition
- Motorized rings allowing control of focus, zoom, iris, and shutters
- Independent lamp position and spot / even adjustments
- Remote control via DMX 512 or Ethernet of all beam shaping functions + pan & tilt
- Yoke repositioning better than 0.1°
- 3-phase stepper motors and no fan ensure true noiseless operation
- Absolute sensor technology = no pan & tilt reset
- Web page interface for bidirectional communication and diagnostics (runs on any browser)
- Colour control with scroller for perfect colour matching
- 360° endless rotation capability of gobos and each individual shutter blade

The absence of fans is the first condition for a truly silent operation!

WARP/M Daylight - Motorized Daylight Zoom Profile Spotlight adapted to host a 575 W discharge lamp.

“**High Quality Image**” features an ellipsoidal reflector optimized for projecting an homogeneous light beam, essential for pattern projection. This fixture can be used for applications where the design requires very even light distribution, e.g. to uniformly cover an acting area, or for high quality gobo projection.

Specific features for the Daylight version of WARP/M:

- G22 axial discharge lamp 575 W / 6000 K / 1000 h / 49000 lm hot restrike
- Light output comparable with the one of a 2500 W daylight lamp with condenser optic system
- 14500 lux at 10 m/12° with Peak Performance reflector
- Dichroic glass reflector for low gate and beam temperature
- Patented ring control of focus, zoom, iris, gobos and shutters
- Individual 360° rotation of shutters and gobos
- Electronic flicker free ballast with integrated 24 V power supply for accessories
- Power supply: 230 V +/- 15% / 50-60 Hz or 90 - 264 V
- Lightweight, compact, robust, ergonomic

Options:

- DMX controlled mechanical dimmer
- Combined mechanical dimmer and colour changer



Zoom Profiles for 600/800 W Halogen & for 575 W Discharge Lamps for Remote Operation

Code	Description	Reference
Motorized Zoom Profile Spotlights		
1017.10.020	WARP/M 12° - 30° / 230 V	WARP/M/12-30
1017.10.030	WARP/M 22° - 50° / 230 V	WARP/M/22-50
1017.10.220	WARP/M 12° - 30° / 90 - 264 V	WARP/M/12-30/U
1017.10.230	WARP/M 22° - 50° / 90 - 264 V	WARP/M/22-50/U
Dimensions		
WARP/M 12°-30°: 748 x 550 x 805 mm - Net Weight: 32 kg		
WARP/M 22°-50°: 658 x 550 x 805 mm - Net Weight: 32 kg		
Lamps		
2990.40.500	G 9.5, biplane filament, halogen lamp 230V-800W-3200K	800W/G9.5/3200K
2990.40.405	G 9.5, biplane filament, halogen lamp 230V-600W-3200K	600W/G9.5/3200K
Warning: WARP halogen spotlights are exclusively designed for a biplane filament halogen lamp with a G9.5 base. Any modification to accommodate another lamp is not allowed and would void CE safety approval and product warranty.		
Motorized Daylight Zoom Profile Spotlights		
1017.10.520	WARP/M/DL 12°-30° / 90-264V	WARP/M/DL/12-30/U/HQ
1017.10.530	WARP/M/DL 22°-50° / 90-264V	WARP/M/DL/22-50/U/HQ
including :		
<ul style="list-style-type: none"> • dichroic glass reflector "High Quality Imaging" • G22 lampholder for 575W daylight discharge lamp • motorized yoke mounted on a control box with integrated flicker free electronic ballast and 24 V power supply for accessories • G22 hot restrike metal halide lamp 575W-6000K-1000h-49000 lm (adjusted) 		
Dimensions		
WARP/M/DL 12°-30°: 800 x 549 x 766 mm - Net Weight: 36 kg		
WARP/M/DL 22°-50°: 706 x 549 x 766 mm - Net Weight: 35.5 kg		
Note:		
Due to higher heat dissipation of the electronic ballast at low voltage, the WARP/DL/U range ballasts are equipped with a low noise fan to ensure reliability.		

Lighting - Theatre Spotlights

WARD & WARD Daylight



WARD - FANLESS Zoom Profile Spotlight

Main Features:

- 12°-30° and 22°-50° versions
- 800 W halogen axial lamp, 230 V, 3200 °K, G9.5
- Light output higher than with a 1200 W conventional profile
- Dichroic glass reflector for low gate and beam temperature
- B size gate for maximum gobo definition
- Innovative ring control of focus, zoom, iris, gobo and shutters
- Individual 360° rotation of shutters and gobos
- Access to all controls from any position around the spotlight
- Independent lamp position and spot / even adjustments
- Holder for one iris diaphragm + one 360° rotating gobo (or two gobos without iris)
- Stepless yoke positioning along the spotlight for balance adjustment
- Innovative, compact, robust, ergonomic design

WARD Daylight - Zoom Profile Spotlight adapted to host a 575 W discharge lamp, available in special rental version and with two optical systems.

“Peak Performance” optical system with ellipsoidal reflector optimized for maximum light output. The fixture gives an extra “punch” of light, very useful for display and highlighting of scenic elements and actors.

“High Quality Image” features an ellipsoidal reflector optimized for projecting an homogeneous light beam, essential for pattern projection. This fixture can be used for applications where the design requires very even light distribution, e.g. to uniformly cover an acting area, or for high quality gobo projection.

Main Features:

- 12°-30° and 22°-50° versions
- G22 axial discharge lamp 575 W / 6000 K / 1000 h / 49000 lm hot restrike
- Light output comparable with the one of a 2500 W daylight lamp with condenser optic system
- 14500 lux at 10 m/12° with Peak Performance reflector
- Dichroic glass reflector for low gate and beam temperature
- Patented ring control of focus, zoom, iris, gobos and shutters
- Individual 360° rotation of shutters and gobos
- Access to all controls from any position around the spotlight
- Electronic flicker free ballast with integrated 24 V power supply for accessories
- Power supply: 230 V +/- 15% / 50-60 Hz or 90 - 264 V
- Convection cooling -> no fan, no noise
- Lightweight, compact, robust, ergonomic



Zoom Profiles for 600/800 W Halogen & for 575 W Discharge Lamps

for Manual Operation

Code	Description	Reference
Zoom Profile Spotlights		
1017.01.020	WARP 12°-30° / 230 V	WARP/12-30
1017.01.030	WARP 22°-50° / 230 V	WARP/22-50
1017.01.220	WARP 12°-30° / 90 - 264 V	WARP/12-30/U
1017.01.230	WARP 22°-50° / 90 - 264 V	WARP/22-50/U
	including :	
	<ul style="list-style-type: none"> dichroic glass reflector 2 zoom lenses with anti-reflection coating patented ring control of all functions G 9.5 lampholder for axial lamp 800 W/230 V 1.6 m power supply cable without plug 1 metal filter frame (185 x 185 mm) 	
	Dimensions	
	WARP 12°-30°: 748 x 495 x 213 mm - Net Weight: 12.2 kg	
	WARP 22°-50°: 655 x 495 x 213 mm - Net Weight: 11 kg	
	Lamps	
2990.40.500	G 9.5, biplane filament, halogen lamp 230V-800W-3200K	800W/G9.5/3200K
2990.40.405	G 9.5, biplane filament, halogen lamp 230V-600W-3200K	600W/G9.5/3200K
	Warning: WARP halogen spotlights are exclusively designed for a biplane filament halogen lamp with a G9.5 base. Any modification to accommodate another lamp is not allowed and would void CE safety approval and product warranty.	
Daylight Zoom Profile Spotlights		
"Peak Performance"		
1017.01.320	WARP/DL 12°-30° / 230V	WARP/DL/12-30
1017.01.330	WARP/DL 22°-50° / 230V	WARP/DL/22-50
1017.01.321	WARP/DL 12°-30° / 90-264V	WARP/DL/12-30/U
1017.01.331	WARP/DL 22°-50° / 90-264V	WARP/DL/22-50/U
Daylight Zoom Profile Spotlights		
"High Quality Imaging"		
1017.01.520	WARP/DL 12°-30° / 230V	WARP/DL/12-30/HQ
1017.01.530	WARP/DL 22°-50° / 230V	WARP/DL/22-50/HQ
1017.01.521	WARP/DL 12°-30° / 90-264V	WARP/DL/12-30/U/HQ
1017.01.531	WARP/DL 22°-50° / 90-264V	WARP/DL/22-50/U/HQ
	including :	
	<ul style="list-style-type: none"> dichroic glass reflector, two possible types are available at the time of ordering: <ul style="list-style-type: none"> "Peak Performance Reflector" gives an extra boost of light in the centre of the field. "High Quality Imaging" renders a flat and even light distribution 2 zoom lenses with anti-reflection coating patented ring control of all functions G22 lampholder for 575W daylight discharge lamp flicker free electronic ballast, with integrated 24 V power supply for accessories, mounted onto the yoke G22 hot restrike metal halide lamp 575W-6000K-1000h-49000 lm (adjusted) 1.6 m power supply cable without plug 1 metal filter frame 	
	Dimensions	
	WARP/DL 12°-30°: 800 x 475 x 500 mm - Net Weight: 18 kg	
	WARP/DL 22°-50°: 706 x 475 x 500 mm - Net Weight: 17.5 kg	

WARD Daylight

Code	Description	Reference
Rental Daylight Zoom Profile Spotlights "Peak Performance"		
1017.01.323	WARD/DL/R 12°-30° / 230V without ballast	WARD/DL/R/12-30
1017.01.333	WARD/DL/R 22°-50° / 230V without ballast	WARD/DL/R/22-50
Rental Daylight Zoom Profile Spotlights "High Quality Imaging"		
1017.01.523	WARD/DL/R 12°-30° / 230V without ballast	WARD/DL/R/12-30/HQ
1017.01.533	WARD/DL/R 22°-50° / 230V without ballast	WARD/DL/R/22-50/HQ
	including :	
	<ul style="list-style-type: none"> • dichroic glass reflector • 2 zoom lenses with anti-reflection coating • patented ring control of all functions • GX9.5 lampholder for 575W daylight discharge lamp • igniter for cold strike • 2 m power supply cable without plug • 1 metal filter frame • 1 safety switch 	
	Warning: Rental daylight WARP are supplied without magnetic or electronic ballast. This must be provided by the customer before operation!	



CC/WARP



COMBO/WARP
for WARP Daylight



MD/WARP
for WARP Daylight



Zoom Profiles for 600/800 W Halogen & for 575 W Discharge Lamps

Accessories

Code	Description	Reference
Accessories for WARP and WARP/M		
1090.52.205	Metal filter frame (185 x 185 mm)	PFM/185
1090.47.050	Safety grid (185 x 185 mm)	GR/185
1000.40.100	Double gobo holder (rotating) type B	SP/2GO/WARP
1000.40.110	Combined iris diaphragm & gobo holder (rotating) type B	SP/OR-GO/WARP
1000.40.120	Single gobo holder (non rotating) for WARP type B	SP-GO/WARP
1017.25.020	Flight-case for WARP/M	FLY/WARP/M1
1017.25.030	Flight-case for 6 WARP	FLY/WARP/6
1192.10.550	Hook clamp for Ø 35 to Ø 50 mm tubes	A20
1192.10.560	Hook clamp for Ø 35 to Ø 50 mm tubes	A25
1092.10.550	Hook clamp for Ø 45 to Ø 60 mm tubes	A30
1092.10.600	Hook clamp for WARP/M (2 required)	A40
1092.00.092	1.2 m spotlight safety cable	CAS120/N
1050.40.405	Colour changer for WARP supplied with : <ul style="list-style-type: none"> • 1 16-colour gel filter roll • 1 adapter plate (APL-CC/WARP) • 1 DMX/supply cable 	CC/WARP
1050.40.400	Adapter plate for colour changer	APL-CC/WARP
Accessories for WARP Daylight and WARP/M Daylight		
1050.40.410	Mechanical dimmer with adapter plate and DMX/supply cable	MD/WARP
1050.40.440	Filter frame holder cassette for the mechanical dimmer	MD/CASS
1050.40.420	"Combo" mechanical dimmer + colour changer with adapter plate and DMX/supply cable (colour string not included!)	MD/CC/WARP
1050.40.405	Colour changer supplied with : <ul style="list-style-type: none"> • 1 16-colour gel filter roll • 1 adapter plate (APL-CC/WARP) • 1 DMX/supply cable 	CC/WARP
1050.40.400	Adapter plate for colour changer	APL-CC/WARP
1050.40.460	Filter frame holder cassette for the "Combo" mechanical dimmer	MD/COMBO/CASS
1050.40.400	Adapter plate for colour changer	APL-CC/WARP
1090.52.205	Metal filter frame (185 x 185 mm)	PFM/185
1090.47.050	Safety grid (185 x 185 mm)	GR/185
1000.40.100	Double gobo holder (rotating) type B	SP/2GO/WARP
1000.40.110	Combined iris diaphragm & gobo holder (rotating) type B	SP/OR-GO/WARP
1000.40.120	Single gobo holder (non rotating) type B for WARP	SP-GO/WARP
1017.25.020	Flight-case for WARP/M/DL	FLY/WARP/M1
1017.25.040	Flight-case for WARP/DL	FLY/WARP/DL
1017.25.030	Flight-case for WARP/DL/Rental	FLY/WARP/6
1192.10.550	Hook clamp for Ø 35 to Ø 50 mm tubes	A20
1192.10.560	Hook clamp for Ø 35 to Ø 50 mm tubes	A25
1092.10.550	Hook clamp for Ø 45 to Ø 60 mm tubes	A30
1092.10.600	Hook clamp for WARP/M/DL (2 required)	A40
1092.00.092	1.2 m spotlight safety cable	CAS120/N

Note: **WARP/DL/Rental** will fit into the flight case for 6 **WARP** spotlights

Lighting - Theatre Spotlights

EUROPE Range

PC and Fresnel Spotlights for 1000 / 1200 W Halogen Lamps

C101 **10° - 65°** **Plano-Convex**

This spotlight, based on high efficiency optics, produces a sharp-edged beam. It can be used for top, front or side lighting.

Field angle adjustable from 10° to 65° (7.5° - 60° beam angle).

Dimensions: 480 x 340 x 420 mm

Net weight: 8 kg



C103 **7° - 61°** **Prism-Convex**

This spotlight, based on high efficiency optics, produces a semisharp-edged beam. It can be used for top, front or side lighting.

Field angle adjustable from 7° to 61° (3.5° - 55° beam angle).

Dimensions: 480 x 340 x 420 mm

Net weight: 9.6 kg



F101 **13° - 59°** **Fresnel**

This spotlight, based on high efficiency optics, produces a softened beam. It can be used on large stages or for studio lighting.

Field angle adjustable from 13° to 59° (7.5° - 52° beam angle).

Dimensions: 340 x 340 x 420 mm

Net weight: 6 kg





The Ultimate in Light Output

1000 / 1200 W PC & Fresnel Spotlights

Code	Description	Reference
1016.12.150	<p>C 101 Plano-convex spotlight 10° - 65°</p> <p>Supplied with :</p> <ul style="list-style-type: none"> • Ø 150 mm plano-convex lens • Glass diffuser • GX 9.5 lampholder • 2 m power supply cable (2 x 1.5 + 1.5 mm²) without plug • 1 integrated safety grid • 1 metal filter frame (185 x 185 mm) 	C 101
1010.12.150	<p>C 103 Prism-convex spotlight 7° - 61°</p> <p>Supplied with :</p> <ul style="list-style-type: none"> • Ø 150 mm prism convex lens • GX 9.5 lampholder • 2 m power supply cable (2 x 1.5 + 1.5 mm²) without plug • 1 integrated safety grid • 1 metal filter frame (185 x 185 mm) 	C 103
1011.12.150	<p>F 101 Fresnel spotlight 13° - 59°</p> <p>Supplied with :</p> <ul style="list-style-type: none"> • Ø 150 mm Fresnel lens • GX 9.5 lampholder • 2 m power supply cable (2 x 1.5 + 1.5 mm²) without plug • 1 integrated safety grid • 1 metal filter frame (185 x 185 mm) <p>Extra charge for pole operation</p> <ul style="list-style-type: none"> • 2 movements : pan + tilt • 3 movements : pan + tilt + focus <p>Motorized yoke: upon request</p> <p>Accessories</p> <ul style="list-style-type: none"> 1090.52.205 Metal filter frame (185 x 185 mm) 1001.50.115 Rotatable 4-leaf barndoor without safety cable 1092.00.094 0.75 m safety cable for barndoors 1192.10.550 Hook clamp for Ø 35 to Ø 50 mm tubes 1192.10.560 Hook clamp for Ø 35 to Ø 50 mm tubes 1092.10.550 Hook clamp for Ø 45 to Ø 60 mm tubes 1092.00.092 1.2 m spotlight safety cable 1090.47.050 Safety grid (185 x 185 mm) <p>Halogen lamps 230 V - GX 9.5 : see relevant page</p>	<p>F 101</p> <p>CP/PC-F/2M/1KW CP/PC-F/3M</p> <p>PFM/185 CFN/185 CAS/CF/75 A20 A25 A30 CAS120/N GR/185</p>

EUROPE Range

1000 / 1200 W Zoom Profile Spotlights with Condenser Optics

DW 105 15° - 38°

Dimensions: 710 x 340 x 420 mm
Net weight: 15 kg



DS 105 15° - 31°

Dimensions: 710 x 340 x 420 mm
Net weight: 14 kg



DSN 105 11° - 23°

Dimensions: 790 x 340 x 420 mm
Net weight: 15.1 kg



DN 105 9° - 20°

Dimensions: 920 x 340 x 420 mm
Net weight: 18.4 kg



DVW 105 38° - 57°

Dimensions: 600 x 340 x 420 mm
Net weight: 13.5 kg





The Ultimate in Light Output

1000 / 1200 W Zoom Profile Spotlights

Code	Description	Reference
1012.10.506	DW105 Zoom profile spotlight 15° - 38° Supplied with : <ul style="list-style-type: none"> • 3 zoom lenses and condenser optics • Anti-reflection coating of all lenses • GX 9.5 lampholder • Set of 4 beam shaping shutters with heat insulated handles • 2 m power supply cable (2 x 1.5 + 1.5 mm²) without plug • 1 metal filter frame (185 x 185 mm) 	DW105
1012.10.606	DS105 Zoom profile spotlight 15° - 31° Supplied with : <ul style="list-style-type: none"> • 2 zoom lenses and condenser optics • Anti-reflection coating of all lenses • GX 9.5 lampholder • Set of 4 beam shaping shutters with heat insulated handles • 2 m power supply cable (2 x 1.5 + 1.5 mm²) without plug • 1 metal filter frame (185 x 185 mm) 	DS105
1012.10.806	DSN105 Zoom profile spotlight 11° - 23 ° Supplied with : <ul style="list-style-type: none"> • 2 zoom lenses and condenser optics • Anti-reflection coating of all lenses • GX 9.5 lampholder • Set of 4 beam shaping shutters with heat insulated handles • 2 m power supply cable (2 x 1.5 + 1.5 mm²) without plug • 1 metal filter frame (185 x 185 mm) 	DSN105
1012.10.706	DN105 Zoom profile spotlight 9° - 20° Supplied with : <ul style="list-style-type: none"> • 2 zoom lenses and condenser optics • Anti-reflection coating of all lenses • GX 9.5 lampholder • Set of 4 beam shaping shutters with heat insulated handles • 2 m power supply cable (2 x 1.5 + 1.5 mm²) without plug • 1 metal filter frame (245 x 245 mm) 	DN105
1012.10.906	DVW105 Zoom profile spotlight 38° - 57° Supplied with : <ul style="list-style-type: none"> • 4 zoom lenses and condenser optics • Anti-reflection coating of all lenses • GX 9.5 lampholder • Set of 4 beam shaping shutters with heat insulated handles • 2 m power supply cable (2 x 1.5 + 1.5 mm²) without plug • 1 metal filter frame (185 x 185 mm) 	DVW105
	Extra charge for pole operation, 2 movements, pan + tilt Motorized yoke: upon request	CP/D1/2M
	Accessories	
1090.52.205	Metal filter frame (185 x 185 mm) for DW, DVW, DS and DSN types	PFM/185
1090.52.305	Metal filter frame (245 x 245 mm) for DN type	PFM/245
1090.47.050	Safety grid (185 x 185 mm) for DW, DVW, DS and DSN types	GR/185
1090.47.060	Safety grid (245 x 245 mm) for DN type	GR/245
1000.40.080	"A" size gobo holder with retention ring	SP-GO/A
1000.40.090	"B" size gobo holder	SP-GO/B
1000.19.531	Iris diaphragm Ø 75	OR/75
1000.19.631	Iris diaphragm Ø 80	OR/80
1000.19.541	Iris diaphragm Ø 80 with black-out	OR/80/BO
1192.10.550	Hook clamp for Ø 35 to Ø 50 mm tubes	A20
1192.10.560	Hook clamp for Ø 35 to Ø 50 mm tubes	A25
1092.10.550	Hook clamp for Ø 45 to Ø 60 mm tubes	A30
1092.00.092	1.2 m spotlight safety cable	CAS120/N

Halogen lamps 230 V - GX 9.5 : see relevant page

Lighting - Theatre Spotlights

EUROPE Range

PC and Fresnel Spotlights for 2000 W Halogen Lamps

C201 **5° - 65°** **Plano-Convex**

This spotlight, based on high efficiency optics, produces a sharp-edged beam. It can be used for top, front or side lighting. Field angle adjustable from 5° to 65° (3,5° - 61° beam angle).

Dimensions: 545 x 400 x 510 mm
Net weight: 12.6 kg



C203 **8° - 58°** **Prism-Convex**

This spotlight, based on high efficiency optics, produces a semi-sharp-edged beam. It can be used for top, front or side lighting. Field angle adjustable from 8° to 58° (4.5° - 54° beam angle).

Dimensions: 545 x 400 x 510 mm
Net weight: 12.6 kg



F201 **12° - 61°** **Fresnel**

This spotlight, based on high efficiency optics, produces a soft-edged beam. It can be used on large stages or for studio lighting. Field angle adjustable from 12° to 61° (6.5° - 55° beam angle).

Dimensions: 425 x 400 x 510 mm
Net weight: 9.6 kg





The Ultimate in Light Output

2000 W PC & Fresnel Spotlights

Code	Description	Reference
1013.20.150	<p>C 201 Plano-convex spotlight 5° - 65°</p> <p>Supplied with :</p> <ul style="list-style-type: none"> • Ø 200 mm PC lens • GY16 lampholder • 2 m power supply cable (2 x 1.5 + 1.5 mm²) without plug • 1 integrated safety grid • 1 metal filter frame (245 x 245 mm) 	C201
1010.20.150	<p>C 203 Prism-convex spotlight 8° - 58°</p> <p>Supplied with :</p> <ul style="list-style-type: none"> • Ø 200 mm prism-convex lens • GY16 lampholder • 2 m power supply cable (2 x 1.5 + 1.5 mm²) without plug • 1 integrated safety grid • 1 metal filter frame (245 x 245 mm) 	C203
1011.20.150	<p>F 201 Fresnel spotlight 12° - 61°</p> <p>Supplied with :</p> <ul style="list-style-type: none"> • Ø 200 mm Fresnel lens • GY16 lampholder • 2 m power supply cable (2 x 1.5 + 1.5 mm²) without plug • 1 integrated safety grid • 1 metal filter frame (245 x 245 mm) <p>Extra charge for pole operation</p> <ul style="list-style-type: none"> • 2 movements: pan + tilt • 3 movements: pan + tilt + focus <p>Motorized yoke: upon request</p> <p>Accessories</p> <p>1090.52.305 Metal filter frame (245 x 245 mm) for DN type</p> <p>1090.47.060 Safety grid (245 x 245 mm)</p> <p>1001.50.215 Rotatable 4-leaf barndoor without safety cable</p> <p>1092.00.094 0.75 m safety cable for barndoors</p> <p>1192.10.550 Hook clamp for Ø 35 to Ø 50 mm tubes</p> <p>1192.10.560 Hook clamp for Ø 35 to Ø 50 mm tubes</p> <p>1092.10.550 Hook clamp for Ø 45 to Ø 60 mm tubes</p> <p>1092.00.092 1.2 m spotlight safety cable</p> <p>Halogen lamp 230 V - GY 16 : see relevant page</p>	<p>F201</p> <p>CP/PC-F/2M/2KW CP/PC-F/3M</p> <p>PFM/245 GR/245 CFN/245 CAS/CF/75 A20 A25 A30 CAS120/N</p>

EUROPE Range

2000 W Zoom Profile Spotlights with Condenser Optics

DS 205 13° - 36°

Dimensions: 810 x 420 x 500 mm

Net weight: 22.7 kg



DN 205 10° - 22°

Dimensions: 935 x 420 x 500 mm

Net weight: 22.9 kg



DVW 205 30° - 54°

Dimensions: 700 x 420 x 500 mm

Net weight: 21.3 kg





The Ultimate in Light Output

2000 W Zoom Profile Spotlights

Code	Description	Reference
1012.20.606	DS 205 zoom profile spotlight 13° - 36°	DS 205
	Supplied with : <ul style="list-style-type: none"> • 3 zoom lenses and condenser optics • Anti-reflection coating of all lenses • Low noise fan • GY16 lampholder • Set of 4 beam shaping shutters with heat insulated handles • 2 m power supply cable (2 x 1.5 + 1.5 mm²) without plug • 1 metal filter frame (245 x 245 mm) 	
1012.20.706	DN 205 zoom profile spotlight 10° - 22°	DN 205
	Supplied with : <ul style="list-style-type: none"> • 2 zoom lenses and condenser optics • Anti-reflection coating of all lenses • Low noise fan • GY16 lampholder • Set of 4 beam shaping shutters with heat insulated handles • 2 m power supply cable (2 x 1.5 + 1.5 mm²) without plug • 1 metal filter frame (245 x 245 mm) 	
1012.20.906	DVW 205 zoom profile spotlight 30° - 54°	DVW 205
	Supplied with : <ul style="list-style-type: none"> • 4 zoom lenses and condenser optics • Anti-reflection coating of all lenses • Low noise fan • GY16 lampholder • Set of 4 beam shaping shutters with heat insulated handles • 2 m power supply cable (2 x 1.5 + 1.5 mm²) without plug • 1 metal filter frame (245 x 245 mm) 	
	Extra charge for pole operation, 2 movements, pan + tilt	CP/D2/2M
	Motorized yoke: upon request	
	Accessories	
1090.52.305	Metal filter frame (245 x 245 mm) for DN type	PFM/245
1090.47.060	Safety grid (245 x 245 mm)	GR/245
1000.40.080	"A" size gobo holder with retention ring	SP-GO/A
1000.40.090	"B" size gobo holder	SP-GO/B
1000.19.531	Iris diaphragm Ø 75	OR/75
1000.19.631	Iris diaphragm Ø 80	OR/80
1000.19.541	Iris diaphragm Ø 80 with black-out	OR/80/BO
1192.10.550	Hook clamp for Ø 35 to Ø 50 mm tubes	A20
1192.10.560	Hook clamp for Ø 35 to Ø 50 mm tubes	A25
1092.10.550	Hook clamp for Ø 45 to Ø 60 mm tubes	A30
1092.00.092	1.2 m spotlight safety cable	CAS120/N
	Halogen lamps 230 V - GY 16 : see relevant page	

EUROPE Range

Fanless Profiles / No Noise



2000/2500 W Fanless Zoom Profile Spotlights with Condenser Optics

DS 256 14° - 38°

Dimensions: 870 x 400 x 500 mm
Net weight: 22.5 kg



DN 256 9° - 22°

Dimensions: 990 x 400 x 500 mm
Net weight: 23 kg



DVW 256 32° - 51°

Dimensions: 770 x 400 x 500 mm
Net weight: 21 kg





The Ultimate in Light Output

2000/2500 W Zoom Profile Spotlights

Code	Description	Reference
1012.20.606	DS 256 zoom profile spotlight 14° - 38°	DS 256
	Supplied with : <ul style="list-style-type: none"> • 3 zoom lenses and condenser optics • Anti-reflection coating of all lenses • Fanless • G22 lampholder • Set of 4 beam shaping shutters with heat insulated handles • 2 m power supply cable (2 x 1.5 + 1.5 mm²) without plug • 1 metal filter frame (245 x 245 mm) 	
1012.20.706	DN 256 zoom profile spotlight 9° - 22°	DN 256
	Supplied with : <ul style="list-style-type: none"> • 2 zoom lenses and condenser optics • Anti-reflection coating of all lenses • Fanless • G22 lampholder • Set of 4 beam shaping shutters with heat insulated handles • 2 m power supply cable (2 x 1.5 + 1.5 mm²) without plug • 1 metal filter frame (245 x 245 mm) 	
1012.20.906	DVW 256 zoom profile spotlight 32° - 51°	DVW 256
	Supplied with : <ul style="list-style-type: none"> • 4 zoom lenses and condenser optics • Anti-reflection coating of all lenses • Fanless • G22 lampholder • Set of 4 beam shaping shutters with heat insulated handles • 2 m power supply cable (2 x 1.5 + 1.5 mm²) without plug • 1 metal filter frame (245 x 245 mm) 	
	Extra charge for pole operation, 2 movements, pan + tilt	CP/D2/2M
	Motorized yoke: upon request	
	Accessories	
1090.52.305	Metal filter frame (245 x 245 mm) for DN type	PFM/245
1090.47.060	Safety grid (245 x 245 mm)	GR/245
1000.40.080	"A" size gobo holder with retention ring	SP-GO/A
1000.40.090	"B" size gobo holder	SP-GO/B
1000.19.531	Iris diaphragm Ø 75	OR/75
1000.19.631	Iris diaphragm Ø 80	OR/80
1000.19.541	Iris diaphragm Ø 80 with black-out	OR/80/BO
1192.10.550	Hook clamp for Ø 35 to Ø 50 mm tubes	A20
1192.10.560	Hook clamp for Ø 35 to Ø 50 mm tubes	A25
1092.10.550	Hook clamp for Ø 45 to Ø 60 mm tubes	A30
1092.00.092	1.2 m spotlight safety cable	CAS120/N
	Halogen lamps 230 V - G22 : see relevant page	

Lighting - Theatre Spotlights

"A" RANGE

Professional Theatre Spotlights for 300 / 500 / 650 W Halogen Lamps

A 56 C **9° - 66°** **Prism Convex**

This spotlight produces a high level output and a top quality diffused edged beam from a tight spot to a wide flood with beam angles from 5° to 63° (field angle 9° - 66°). Providing a tighter and more controlled beam than a Fresnel, the A 56 C is ideal for front or side lighting on small stages where a maximum of 650 W is required.

Dimensions: 290 x 225 x 330 mm
Net weight: 3.5 kg



A 57 F **14° - 59°** **Fresnel**

This spotlight produces a high output level and a soft-edged beam, variable from a tight spot of 8° to a wide flood of 51° (field angle 14° - 59°). It is intended for side, back or general lighting, as well as for application in small studios.

Dimensions: 290 x 225 x 330 mm
Net weight: 3.4 kg



A 59 Z **16° - 35°** **Zoom Profile with Condenser Optics**

This spotlight, fitted with a spherical mirror and condenser optics, produces excellent light levels and beam quality. As a variable beam angle profile, the A 59 Z has a very useful range of 16° to 35° and provides a good directional light with cut off beam and variable sharpness. It is perfect for use in smaller venues and to highlight details on larger stages.

Dimensions: 515 x 225 x 330 mm
Net weight: 5.8 kg





Professional Theatre Spotlights for 300 / 500 / 650 W Halogen Lamps

Code	Description	Reference
1005.31.560	A 56 C Prism convex spotlight 9° - 66° Supplied with : <ul style="list-style-type: none"> • Ø 120 mm prism convex lens • GY 9.5 lampholder • 2 m silicone power supply cable (2 x 1.5 + 1.5 mm²) without plug • 1 safety grid (155 x 155 mm) • 1 metal filter frame (155 x 155 mm) 	A 56 C
1005.31.570	A 57 F Fresnel spotlight 14° - 59° Supplied with : <ul style="list-style-type: none"> • Ø 120 mm Fresnel lens • GY 9.5 lampholder • 2 m power supply cable (2 x 1.5 + 1.5 mm²) without plug • 1 safety grid • 1 metal filter frame (155 x 155 mm) 	A 57 F
1005.31.590	A 59 Z Zoom profile spotlight 16° - 35° Supplied with : <ul style="list-style-type: none"> • 2 zoom lenses and condenser optics • GY 9.5 lampholder • 4 beam shaping shutters with heat insulated handles • 2 m power supply cable (2 x 1.5 + 1.5 mm²) without plug • 1 metal filter frame (155 x 155 mm) 	A 59 Z
	Accessories	
1090.52.110	Metal filter frame (155 x 155 mm)	PFM/A650
3203.10.130	Safety grid (155 x 155 mm)	GR/A650
1090.61.010	Rotatable 4-leaf barndoor for A 57 F and A 56 C	CF/A650
1000.19.200	Iris diaphragm for A 59 Z	OR/A650
1000.40.065	Double gobo holder for A 59 Z	SP/A650
1092.10.505	Hook clamp for Ø 21 to Ø 48 mm tubes	A6
1192.10.550	Hook clamp for Ø 35 to Ø 50 mm tubes	A20
1192.10.560	Hook clamp for Ø 35 to Ø 50 mm tubes	A25
1092.10.550	Hook clamp for Ø 45 to Ø 60 mm tubes	A30
1092.00.092	1.2 m spotlight safety cable	CAS120/N

Halogen lamps 230 V - GY 9.5 : see relevant page

EUROSPOT

General Purpose Theatre Spotlights for 300 / 500 / 650 W Halogen Lamps

F 51 18° - 65° Fresnel spotlight

The F51 is characterised by a soft-edged beam variable from a tight spot of 18° to a wide flood of 65°.

Dimensions: 245 x 220 x 240 mm
Net weight: 2.2 kg



C 51 9° - 60° Prism-convex spotlight

The C51 is characterised by a semi-sharp edged beam variable from a tight spot of 9° to a wide flood of 60°.

Dimensions: 310 x 220 x 260 mm
Net weight: 2.7 kg



DS 54 18° - 38° Zoom profile spotlight with condenser optics

The DS54 is a variable angle profile spotlight, equipped with 2 individually adjustable zoom lenses. It provides a sharp or soft-edged beam over a very useful range of 18° to 38°. Zoom focusing is smooth and stable in any position. The use of high quality condenser optics results into a superior beam quality and very accurate imaging capabilities.

Dimensions: 440 x 220 x 260 mm
Net weight: 3.7 kg



DW 54 30° - 47° Zoom profile spotlight with condenser optics

The DW54 is a variable 30°-47° wide angle profile spotlight, equipped with 2 individually adjustable zoom lenses. Zoom focusing is smooth and stable in any position. The use of high quality condenser optics results into an even light distribution at wide angles with very accurate imaging capabilities. This makes the DW 54 a very useful complement to the DS 54 (18°-38°) of the same family.

Dimensions: 370 x 220 x 260 mm
Net weight: 3.5 kg





General Purpose Theatre Spotlights for 300 / 500 / 650 W Halogen Lamps

Code	Description	Reference
1005.32.100	F 51 Fresnel spotlight 18° - 65° Supplied with : <ul style="list-style-type: none"> • Ø 112 mm Fresnel lens • GY9.5 lampholder • 1 m power supply cable (2 x 1.5 + 1.5 mm²) without plug • 1 safety grid • 1 metal filter frame (125 x 125 mm) 	F51
1005.32.110	C 51 Prism-convex spotlight 9° - 60° Supplied with : <ul style="list-style-type: none"> • Ø 112 mm prism convex lens • GY9.5 lampholder • 1 m power supply cable (2 x 1.5 + 1.5 mm²) without plug • 1 safety grid • 1 metal filter frame (125 x 125 mm) 	C51
1005.32.130	DS 54 Zoom profile spotlight 18°- 38° Supplied with : <ul style="list-style-type: none"> • 2 zoom lenses and 1 condenser lens • GY9.5 lampholder • 4 beam shaping shutters with isolated handles • 1 m power supply cable (2 x 1.5 + 1.5 mm²) without plug • 1 safety grid • 1 metal filter frame (125 x 125 mm) 	DS54
1005.32.140	DW 54 Zoom profile spotlight 30°- 47° Supplied with : <ul style="list-style-type: none"> • 2 zoom lenses and 1 condenser lens • GY9.5 lampholder • 4 beam shaping shutters with isolated handles • 1 m power supply cable (2 x 1.5 + 1.5 mm²) without plug • 1 safety grid • 1 metal filter frame (125 x 125 mm) 	DW54
	Accessories	
1090.52.905	Metal filter frame (125 x 125 mm)	PFM/EURO
1090.62.205	Rotatable 4-leaf barndoor for F51 and C51	CF/EURO
1000.19.645	Iris diaphragm for DS and DW profiles	OR/EURO
1000.40.045	Gobo holder for DS and DW profiles	SP/GO/EURO
1092.10.505	Hook clamp for Ø 21 to Ø 48 mm tubes	A6
1192.10.550	Hook clamp for Ø 35 to Ø 50 mm tubes	A20
1192.10.560	Hook clamp for Ø 35 to Ø 50 mm tubes	A25
1092.10.550	Hook clamp for Ø 45 to Ø 60 mm tubes	A30
1092.00.092	1.2 m spotlight safety cable	CAS120/N

Halogen lamps 230 V - GY 9.5 : see relevant page

ALC4-2



General Characteristics

- Cyclorama and fill light fixture for Theatre and TV Studio Lighting.
- Dynamic RGB + White module with 4 x 50 W LED sources, factory calibrated.
- Even light distribution through high brilliance aluminum reflector.
- Selectable beam angle through asymmetric or symmetric reflector, or 4-leaf reflective barndoor.
- Full RGB + White allowing more than one million colours, including pure yellow and full amber.
- Compact, light weight unit.

Specific Characteristic

- Pole operated movement ALC4-2 / PO with PAN & TILT.

User Benefits

- Excellent color uniformity between several sources with no color separation between beams and no coloured shadows.
- 7 “calibrated” preset “White” levels between 2700K and 6500K.
- Stepless control from warm-white 2700K to daylight 6500K.
- Closed-loop optical feedback circuit in each LED source guarantees consistency in colour, white and light output.
- Creation of various background illuminations and / or effects.
- Smooth, flicker-free light output, without any colour or white changes when dimmed.
- High efficiency and major energy savings in comparison with halogen fixtures.
- Removable reflector allowing other beam control accessories.
- Reduced CO2 footprint compared with conventional halogen fixtures.

ALC4-2 is a unique, state-of-the-art product, another ADB innovation





LED Fixtures

Code	Description	Reference
1060.20.000	ALC4-2 - LED RGB+White Fixture	ALC4-2
1060.21.000	ALC4-2 - LED RGB+White Fixture with pole operated movement	ALC4-2/PO

Supplied with :

- 4 StagePainter D60 2000 light sources
- clamping tool for mounting the instrument on a pipe with an optional hook
- 1.6 m power supply cable with POWERCON twist-lock connector and with open ends on the other side

ALC4-2 Features:

- high illumination quality
- closed-loop optical feedback for consistent color and intensity
- white color temperature presets from 2,700K to 6,500K
- completely mixed source with excellent color uniformity and no color separation in the beam
- no degrading ultraviolet or uncomfortable infrared wavelengths in beam
- sustainable and environmentally friendly
- robust package absent of fragile glass
- reduced CO2 footprint compared to conventional halogen fixtures
- no waste (gels, lamps, etc.) throughout the product life

Dimensions

with asymmetric reflector: 380 x 605 x 495 mm

without reflector: 182 x 496 x 268 mm

Net weight: 10 kg

Accessories

1060.10.010	Asymmetric Cyclorama reflector	REF/ASYM/ALC4
1060.10.020	Symmetric reflector for further throw distance	REF/SYM/ALC4
1060.10.050	Symmetric reflector for further throw distance 36°	REF/SYM36/ALC4
1060.10.030	Barndoor with high efficiency reflecting surface	REF/CF/ALC4
1060.10.080	20° Honeycombs for REF/CF/ALC4	ALC4/H20
1060.10.081	40° Honeycombs for REF/CF/ALC4	ALC4/H40
1060.10.082	60° Honeycombs for REF/CF/ALC4	ALC4/H60
1060.10.040	Interconnection power supply cable (2 m)	PWRLNK/2M/ALC4

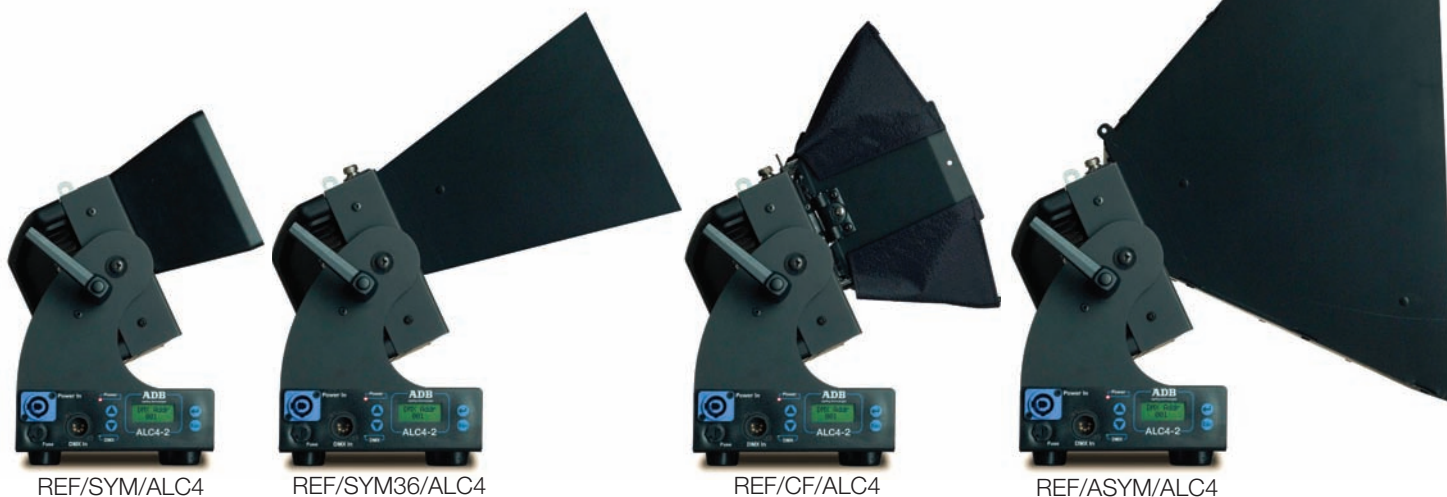

Cyclorama Lights



ACP 1000

Cyclorama light with asymmetrical reflector for use with gel filter

Dimensions: 390 x 450 x 230 mm

Net weight: 5 kg

The ACP Cyclorama lights features a unique combination of an asymmetrical reflector and 2, highly reflective side mirrors to provide high quality lighting for both studio and stage applications.

These fixtures are ideal for creating an homogenous light level or for stage set lighting, e.g.

- vertical, even illumination of cyclorama or horizon screen
- diffused back lighting
- asymmetrical soft light

These compact and lightweight luminaires are designed for use with 625 W, 1000 W or 1250 W clear or frosted halogen lamps, and either gel or glass colour filters.

Excellent ventilation by natural convection ensures long life of lamps and filters.

Flexibility is provided by a large choice of single, double, triple or quadruple units assembled in either horizontal, vertical or square formats.

Each combination can be supplied for manual or pole operation.



625 W / 1000 W / 1250 W Cyclorama Lights

Code	Description	Reference
ACP 1000 Cyclorama		
1060.02.020	single for	- gel filters ACP1001
1060.02.040	double horizontal for	- gel filters ACP1002H
1060.02.100	double vertical for	- gel filters ACP1002V
1060.02.120	triple in line for	- gel filters ACP1003H
1060.02.060	quadruple in line for	- gel filters ACP1004H
1060.02.080	quadruple in square for	- gel filters ACP1004C
Supplied with :		
<ul style="list-style-type: none"> • R7S lampholder • Safety grid with 3 mm meshing • 2 m power supply cable (2 x 1.5 + 1.5 mm²) without plug 		
Extra charge for pole operation (1 movement : pan)		
Accessories		
1090.16.040	Vertical barndoors (set of 2 pieces, 1 right & 1 left)	CFV/ACP
1090.16.080	Horizontal barndoor (one bottom part)	CFH/ACP
1192.10.550	Hook clamp for Ø 35 to Ø 50 mm tubes	A20
1192.10.560	Hook clamp for Ø 35 to Ø 50 mm tubes	A25
1092.10.550	Hook clamp for Ø 45 to Ø 60 mm tubes	A30
1092.10.505	Hook clamp for Ø 21 to Ø 48 mm tubes	A6
1092.00.092	1.2 m safety cable	CAS120/N
Halogen Lamps 230 V - R7S : see relevant page		

Fill Lights

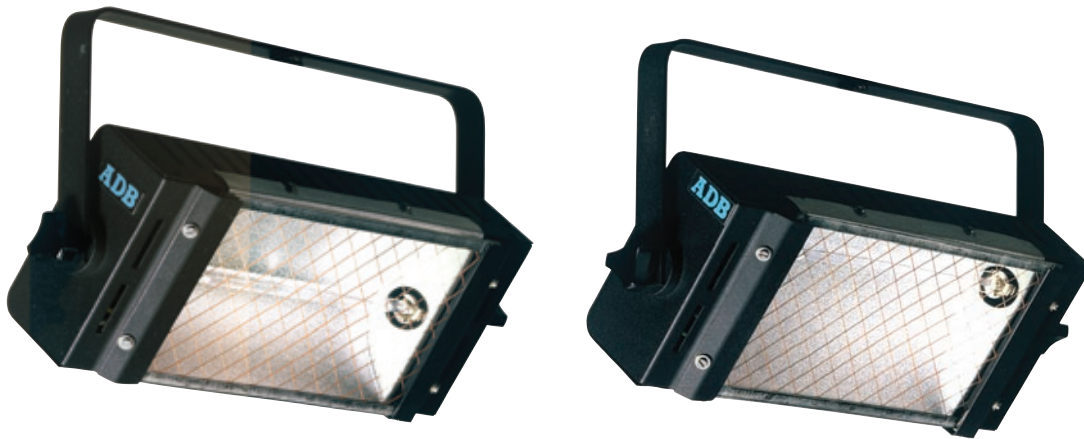

LF 1000 Fill Light with symmetrical Reflector

General purpose fill light for creating even and soft lighting at short distance. Fitted with a 1000 W lamp, it will yield an axial light intensity of 10,000 cd. It can also be used as a high intensity batten when 4 units or more are mounted in a row.

Dimensions: 350 x 190 x 70 mm
Net weight: 1.5 kg

HF 1000 Fill Light with asymmetrical Reflector

Small cyclorama light for perfectly diffused lighting of projection plans, such as cyclorama, back cloth, wall or scenery. A 4-unit row can be used as a 4-colour cyclorama light. Fitted with a 1000 W lamp, a row of 7 units at 3 m from the cloth, equidistant from each other, will provide a light level of 1000 lux in the median lines and in the plane of a 10 m wide and 5 m high cyclorama.

Dimensions: 350 x 190 x 70 mm
Net weight: 1.5 kg

These 2 fixtures, fitted with a slewing aluminium reflector, are intended to provide even and soft lighting at short distance. They are particularly suitable for creating a diffused, homogenous light level for small to medium size theatre stages, TV studios, conference rooms...

LF 1000 and HF 1000 fill lights are designed for 230 V / 625 W, 1000 W or 1250 W tubular halogen lamps. Their small size and low weight make them easy to transport and install.



625 W / 1000 W / 1250 W Fill Lights

Code	Description	Reference
LF / HF 1000 Fill Lights		
1035.01.010	LF 1000 - with symmetrical reflector	LF1000
1035.05.120	HF 1000 - with asymmetrical reflector	HF1000
	Supplied with :	
	<ul style="list-style-type: none"> • R7S lampholder • Safety grid with 3 mm meshing • 2 m power supply cable (2 x 1.5 + 1.5 mm²) without plug 	
Accessories		
1035.01.060	Filter frame holder cassette	ACV/F1000
1035.08.110	Set of 2 vertical barndoors for LF/HF 1000	CFV1/F1000
1035.08.210	Set of 2 horizontal barndoors for LF/HF 1000 or ACV/F 1000	CFH/F1000
1035.08.310	Set of 2 vertical barndoors for ACV/F 1000	CFV2/ACV/F1000
1035.08.410	Set of 4 filter frames for glass filters with safety grid	PF/ACV/F1000
1035.08.910	Bracket stand for assembly of 4 LF/HF 1000	BAR/F1000
1092.10.505	Hook clamp for Ø 21 to Ø 48 mm tubes	A6
1192.10.550	Hook clamp for Ø 35 to Ø 50 mm tubes	A20
1192.10.560	Hook clamp for Ø 35 to Ø 50 mm tubes	A25
1092.10.550	Hook clamp for Ø 45 to Ø 60 mm tubes	A30
1092.00.092	1.2 m safety cable	CAS120/N
Halogen Lamps 230 V - R7S : see relevant page		

SVOBODA



General Characteristics

- Highlights the action on stage
- Dramatises the actors' expression
- Creates ethereal scenery
- Isolates areas on the stage
- Modifies the volumes by creating "lightscreens"
- Communicates sublimated concepts

The SVOBODA, lighting batten was designed by the famous scenographer Josef Svoboda, in cooperation with the lighting specialists of ADB. SVOBODA had long been looking for an unusual way of creating dramatic scenery using light only.

The result is the SVOBODA, a 2250 W or 2500 W batten made of nine or ten 24 V lamps, delivering a very bright and quasi parallel light beam, the "Light Curtain". Used as backlighting, cascade or full-on frontal, the SVOBODA provides unique lighting, soft and yet intense at the same time, creating an atmosphere in a class of its own.

2 Types

- HT 2500 (10 lamps) for 110 V / 120 V power supply
- HT 2251 (9 lamps) for 230 V power supply

Earth connection provided. Usable with gel filters.

Motorized yoke is available upon request





SVOBODA Lighting Batten

Code	Description	Reference
	SVOBODA	
1070.05.012	SVOBODA Lighting Batten (230V) with: <ul style="list-style-type: none"> Aluminium body 9 individual units E 40 lampholders for 250 W/24 V mirror lamps with 2 m power supply cable with POWERCON twist-lock connector 	HT2251/ALU/ADB
	SVOBODA Lighting Batten (120/240V) with: <ul style="list-style-type: none"> Aluminium body 10 individual units E 40 lampholders for 250 W/24 V mirror lamps with 2 m power supply cable with POWERCON twist-lock connector 	HT2500/ALU/ADB
	Motorized yoke: upon request	
	Accessory	
1092.00.100	Suspension cable (one unit)	CS/HT2251
	250 W - 24 V - E 40 Mirror lamp : see relevant page	
	Dimensions: 1001 x 436 x 190 mm	
	Net weight: 16.3 Kg (without lamps) - 17.1 Kg (with lamps)	

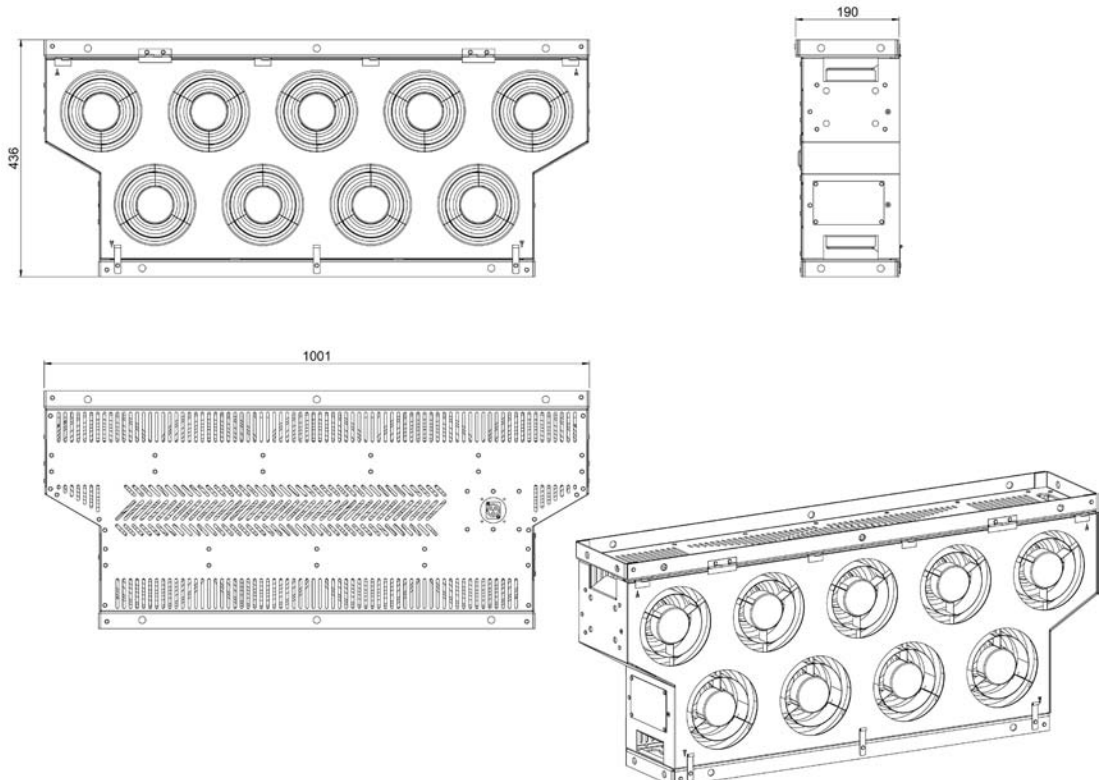

Lighting - Multi-Purpose Luminaires

SOFTLUX

SOFTLUX cool lights are intended to provide cool running, continuous lighting, with either Tungsten (3200 °K) or Daylight (5200 °K - 5600 °K) balance, in Film and Studio applications. They range from 110 W to 440 W in various combinations of 55 W fluorescent lamps.

SOFTLUX produces 300 % to 400 % more lumen per Watt than conventional tungsten lamps resulting in less heat emission, less power consumption, more comfort for the subject and a greatly reduced HVAC cost.

SOFTLUX fluorescent lamps will last a minimum of 6000 h, 60 times longer than conventional tungsten or HMI lamps, without degradation and loss of colour balance.

SOFTLUX dimming is through the DMX signal of a lighting console, and/or a local potentiometer.

SOFTLUX combines a specially designed lamp/reflector unit which gives a symmetrical, directional "punchy" light output and allows longer throw or wider spread as required. The simple attachment of a honeycomb screen allows local light control with 20°, 40° or 60° field angle.

SOFTLUX Linear Space Lights

SLW 220 & SLW 440, fitted with 2 or 4 pairs of 55 W lamps mounted side by side with an integral, 4-leaf black barndoor and optional eggcrate, are intended to produce a wide angular light with relatively sharp edges for illuminating areas, walls, groups of artists and even cyclorama.

SOFTLUX combines modern advances in fluorescent lamp technology and electronic control to provide a powerful, flickerfree light source, both flexible and easy to use.

SOFTLUX comes into a very rigid, lightweight aluminium body, slim and rounded for maximum operational safety, with an elegant finish in a dark grey semi-gloss paint. Other colours upon request.

SOFTLUX fixtures are supplied with:

- a 4-leaf reflective barndoor (SL types)
 - a 4-leaf black barndoor (SLW types)
 - a yoke with central hole Ø 11 mm for DIN Spigot, BS4015 or standard hook clamp
 - a 2 m power supply cable with open end.
- Lamps are not included.



SOFTLUX 110 W

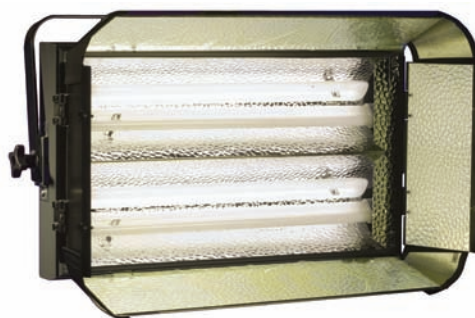

SOFTLUX 220 W

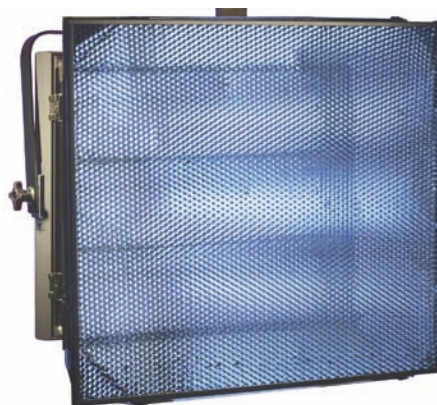

SOFTLUX 330 W with honeycombs



SOFTLUX 440 W



SOFTLUX Cool Lights

110 / 220 / 330 / 440 W

Code	Description	Reference
SOFTLUX Cool Lights - Manual operation		
with 4-leaf reflective barndoor, 2 m cable, without lamps		
1075.00.080	SOFTLUX 110W - 2 x 55W - 230V DMX/Local Control	SL110/DMX/LC
1075.00.090	SOFTLUX 220W - 4 x 55W - 230V DMX/Local Control	SL220/DMX/LC
1075.00.100	SOFTLUX 330W - 6 x 55W - 230V DMX/Local Control	SL330/DMX/LC
1075.00.105	SOFTLUX 440W - 8 x 55W - 230V DMX/Local Control	SL440/DMX/LC
SOFTLUX Cool Lights - Pole operation		
with 4-leaf reflective barndoor, 2 m cable, without lamps		
1075.01.080	SOFTLUX 110W - 2 x 55W - 230V DMX/Local Control	SL110/DMX/LC/PO
1075.01.090	SOFTLUX 220W - 4 x 55W - 230V DMX/Local Control	SL220/DMX/LC/PO
1075.01.100	SOFTLUX 330W - 6 x 55W - 230V DMX/Local Control	SL330/DMX/LC/PO
1075.01.105	SOFTLUX 440W - 8 x 55W - 230V DMX/Local Control	SL440/DMX/LC/PO
SOFTLUX Linear Space Lights		
with 4-leaf black barndoor, 2 m cable, without lamps		
1075.02.090	SOFTLUX 2 x 110W in line - 4 x 55W - 230V DMX/Local Control	SLW220/DMX/LC
1075.02.105	SOFTLUX 4 x 110W in line - 8 x 55W - 230V DMX/Local Control	SLW440/DMX/LC
Dimensions		
SL 110/DMX/LC: 645 x 230 x 605 mm - Net weight: 5 kg		
SL 220/DMX/LC: 645 x 380 x 605 mm - Net weight: 7 kg		
SL 330/DMX/LC: 645 x 530 x 605 mm - Net weight: 9 kg		
SL 440/DMX/LC: 645 x 680 x 605 mm - Net weight: 11 kg		
Accessories		
1075.00.188	Integral safety grid and colour frame for SL110	SL110/SGCF
1075.00.198	Integral safety grid and colour frame for SL220	SL220/SGCF
1075.00.208	Integral safety grid and colour frame for SL330	SL330/SGCF
1075.00.408	Integral safety grid and colour frame for SL440	SL440/SGCF
	Integral safety grid and colour frame for SLW220	SLW220/SGCF
	Integral safety grid and colour frame for SLW440	SLW440/SGCF
	Swivel arm for SL110 and SL220, including mounting bracket	SWIVARM110/220
1075.00.182	20° Honeycombs for SOFTLUX SL110	SL110/H20
1075.00.184	40° Honeycombs for SOFTLUX SL110	SL110/H40
1075.00.186	60° Honeycombs for SOFTLUX SL110	SL110/H60
1075.00.192	20° Honeycombs for SOFTLUX SL220	SL220/H20
1075.00.194	40° Honeycombs for SOFTLUX SL220	SL220/H40
1075.00.196	60° Honeycombs for SOFTLUX SL220	SL220/H60
1075.00.202	20° Honeycombs for SOFTLUX SL330	SL330/H20
1075.00.204	40° Honeycombs for SOFTLUX SL330	SL330/H40
1075.00.206	60° Honeycombs for SOFTLUX SL330	SL330/H60
1075.00.402	20° Honeycombs for SOFTLUX SL440	SL440/H20
1075.00.404	40° Honeycombs for SOFTLUX SL440	SL440/H40
1075.00.405	60° Honeycombs for SOFTLUX SL440	SL440/H60
1075.02.192	20° Honeycombs for SOFTLUX SLW220	SLW220/DMX/H20
1075.02.194	40° Honeycombs for SOFTLUX SLW220	SLW220/DMX/H40
1075.02.196	60° Honeycombs for SOFTLUX SLW220	SLW220/DMX/H60
1075.02.402	20° Honeycombs for SOFTLUX SLW440	SLW440/DMX/H20
1075.02.404	40° Honeycombs for SOFTLUX SLW440	SLW440/DMX/H40
1075.02.406	60° Honeycombs for SOFTLUX SLW440	SLW440/DMX/H60

Fluorescent Lamps 230 V: see relevant page

Accessories

Lamps

Code	Description	Reference
G 9.5 Biplane Filament Halogen Lamps (for WARP)		
2990.40.500	230 V 800 W 3200 K 300 h BP	800W/G9.5/3200K
2990.40.505	230 V 600 W 3200K 300 h BP	600W/G9.5/3200K
GY 9.5 Halogen Lamps (for EUROSPOT / "A" Range)		
2990.40.205	230 V 300 W 2800 K 2000 h M	300W/GY9.5/2800K
2990.40.300	230 V 500 W 3200 K 150 h MP	500W/GY9.5/3200K
2990.40.305	230 V 500 W 3050 K 400 h BP	500W/GY9.5/3050K
2990.40.310	230 V 500 W 2900 K 2000 h M	500W/GY9.5/2900K
2990.40.458	230 V 650 W 3050 K 400 h M	650W/GY9.5/3050K
GX 9.5 Halogen Lamps (for EUROPE)		
2990.40.470	230 V 650 W 3000 K 750 h BP	650W/GX9.5/3000K
2990.40.456	230 V 650 W 3200 K 100 h BP	650W/GX9.5/3200K
2990.40.603	230 V 1000 W 3050 K 750 h BP	1000W/GX9.5/3050K
2990.40.600	230 V 1000W 3200K 200 h BP	1000W/GX9.5/3200K
2990.40.625	230 V 1200W 3200K 200 h BP	1200W/GX9.5/3200K
GY 16 Halogen Lamp (for EUROPE)		
2990.40.800	230 V 2000 W 3200 K 400 h BP	2000W/G22/3200K
G22 Halogen Lamp (for EUROPE 256 profiles)		
2990.40.617	230 V 2000 W 3200 K 400 h BP	2000W/G22/3200K
2990.40.618	230 V 2500 W 3200 K 400 h BP	2500W/G22/3200K
R7S Halogen Lamps (for Soft & Fill Lights)		
2990.45.340	230 V 625 W 3200 K 200 h	625W/R7S/3200K
2990.45.400	230 V 1000 W 3000 K 2000 h	1000W/R7S/3000K
2990.45.405	230 V 1000 W 3200 K 200 h	1000W/R7S/3200K
2990.45.450	230 V 1250 W 3200 K 200 h	1250W/R7S/3200K
E40 Halogen Lamp (for SVOBODA)		
2990.18.230	24 V 250 W mirrored	M.E40.250
G22 Metal Halide Lamps (for WARP/DL)		
2990.40.510	575 W 6000 K 1000 h 49,000 lm	MSR/575/HR
2990.40.515	575 W 6000 K 2000 h 46,000 lm	MSD/575/HR
2990.40.516	575 W 6000 K 750 h 49,000 lm	HMI/575/SE
2990.40.517	575 W 6000 K 1000 h 49,000 lm	HMI/575/SEL
GX9.5 Metal Halide Lamp (for WARP/DL/Rental)		
2990.40.508	575 W 7200 K 1000 h 49,000 lm	MSR/575/2
230 V Fluorescent Lamps (for SOFTLUX Cool Lights)		
2990.18.553	DULUX/L 55 W 3000 K 3000 lm	DULL/55W/930
2990.18.554	DULUX/L 55 W 5400 K 3000 lm	DULL/55W/954
2990.18.551	STUDIOLINE 55 W 3200 K 3800 lm	STUD/55W/32
2990.18.550	STUDIOLINE 55 W 5600 K 3800 lm	STUD/55W/56

Note:

STUDIOLINE lamps feature an excellent colour stability and a perfect compatibility with halogen and HMI sources.

Code	Description	Reference
Gobo Holders		
1000.40.045	For gobo type M for EUROSPOT	SP/GO/EURO
1000.40.065	Double for gobo type M for A59Z	SP/A650
1000.40.080	For gobo type A (Ø 100) with retention ring for EUROPE	SP-GO/A
1000.40.090	For gobo type B (Ø 85) for EUROPE	SP-GO/B
1000.40.100	Double gobo holder for WARP (rotating) type B	SP/2GO/WARP
1000.40.120	Single gobo holder for WARP (non rotating) type B	SP-GO/WARP

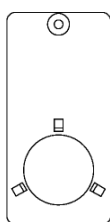

SP/GO/EURO

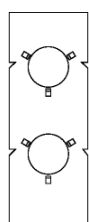

SP/A650

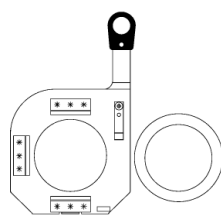

SP-GO/A

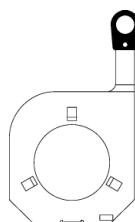

SP-GO/B



SP/2GO/WARP

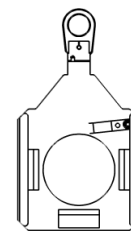

SP-GO/WARP

Iris Diaphragms

1000.19.645	Iris Diaphragm for DS/DW 54 spotlights	OR/EURO
1000.19.200	Iris Diaphragm for A59 Z spotlight	OR/A650
1000.19.531	Iris Diaphragm Ø 75 for EUROPE range	OR/75
1000.19.631	Iris Diaphragm Ø 80 for EUROPE range	OR/80
1000.19.541	Iris Diaphragm Ø 80 with black-out for EUROPE range	OR/80/BO
1000.40.110	Combined iris and gobo holder for WARP (rotating) type B	SP/OR-GO/WARP

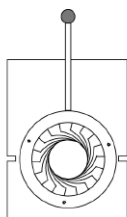

OR/A650

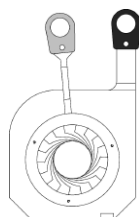

OR/75

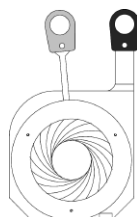

OR/80

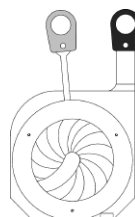

OR/80/BO



SP/OR-GO/WARP

Spotlight Accessories

Code	Description	Reference
General Accessories		
1092.15.110	Low stand with Ø 4 x 11 mm assembly holes and M10 fixing nut	S2
1092.10.505	Hook clamp for Ø 21 to 48 mm tubes, with M10 tapped hole and M10 x 45 wing screw	A6
1092.10.950	Hook clamp for Ø 34 to 60 mm tubes with DIN spigot adapter	A8
1192.10.550	Hook clamp for Ø 35 to 50 mm tubes, equipped with one M10 x 45 welded screw and one M10 wing nut	A20
1192.10.560	Hook clamp for Ø 35 to 50 mm tubes, with M10 tapped hole and M10 x 35 wing screw	A25
1092.10.550	Hook clamp for Ø 45 to 60 mm tubes, with M10 tapped hole and M10 x 35 wing screw	A30
1092.10.600	Hook clamp for Ø 48 to 51 mm tubes, with clamping collar for WARP/M (2 required)	A40
1092.00.092	1.2 m spotlight safety cable	CAS120/N
1092.00.094	0.75 m safety cable for CFN/185, CFN/245, CF/S10 and CF/S20 barndoors	CAS/CF/75
1092.00.093	1 m safety cable for CF/S50 barndoor	CAS/CF/100
1092.20.315	DIN spigot	PIVOT DIN
1092.20.601	DIN spigot adapter	DOUILLE DIN

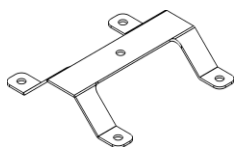

S2

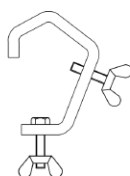

A6

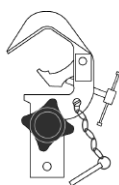

A8

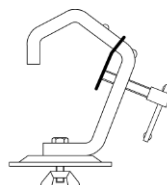

A20

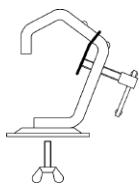

A25

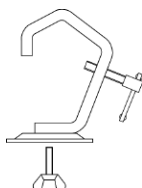

A30

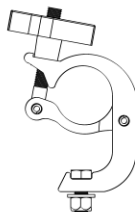

A40



PIVOT DIN

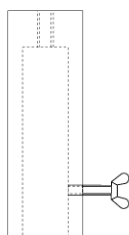

DOUILLE DIN

Glyndebourne - Glyndebourne Opera House - United Kingdom

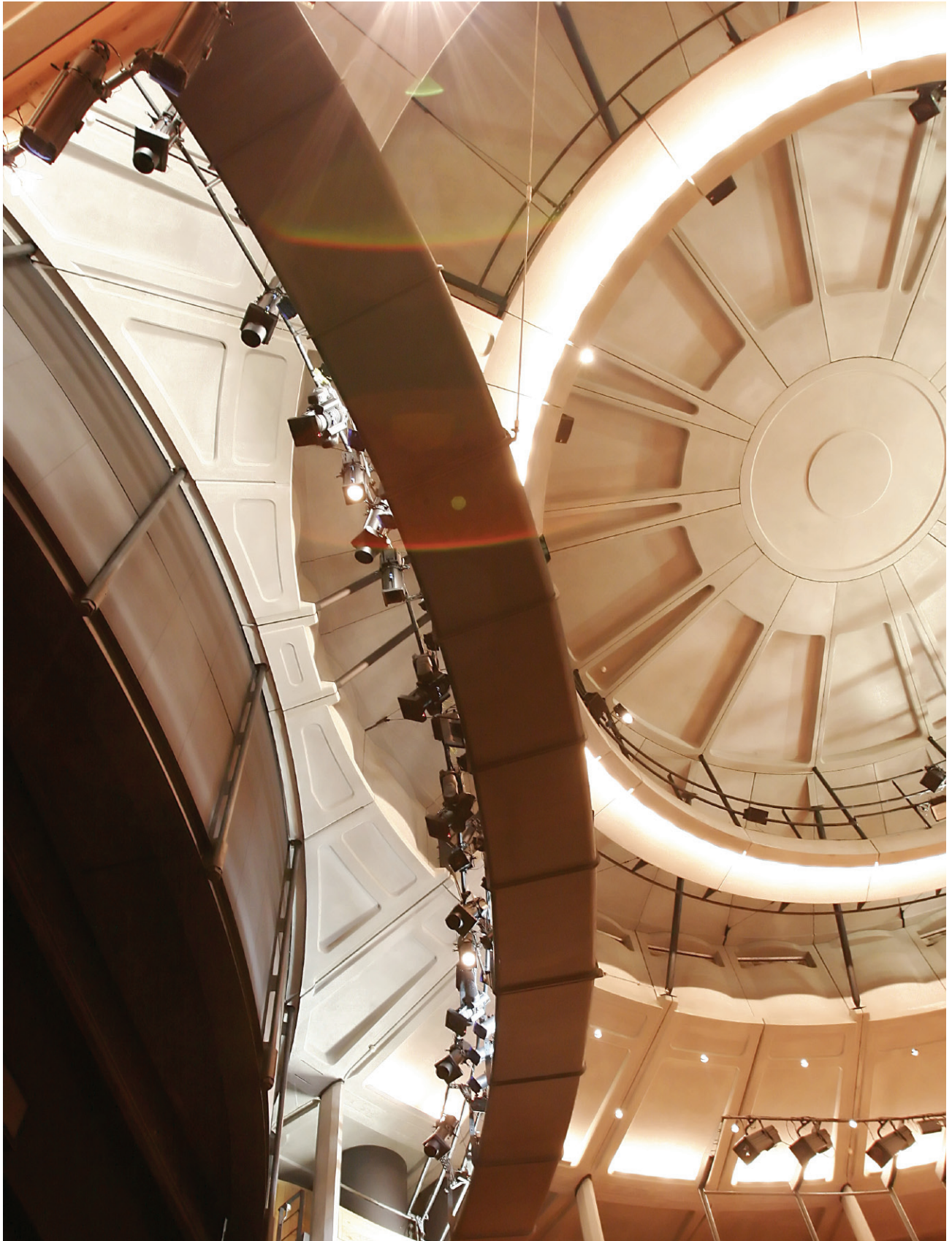

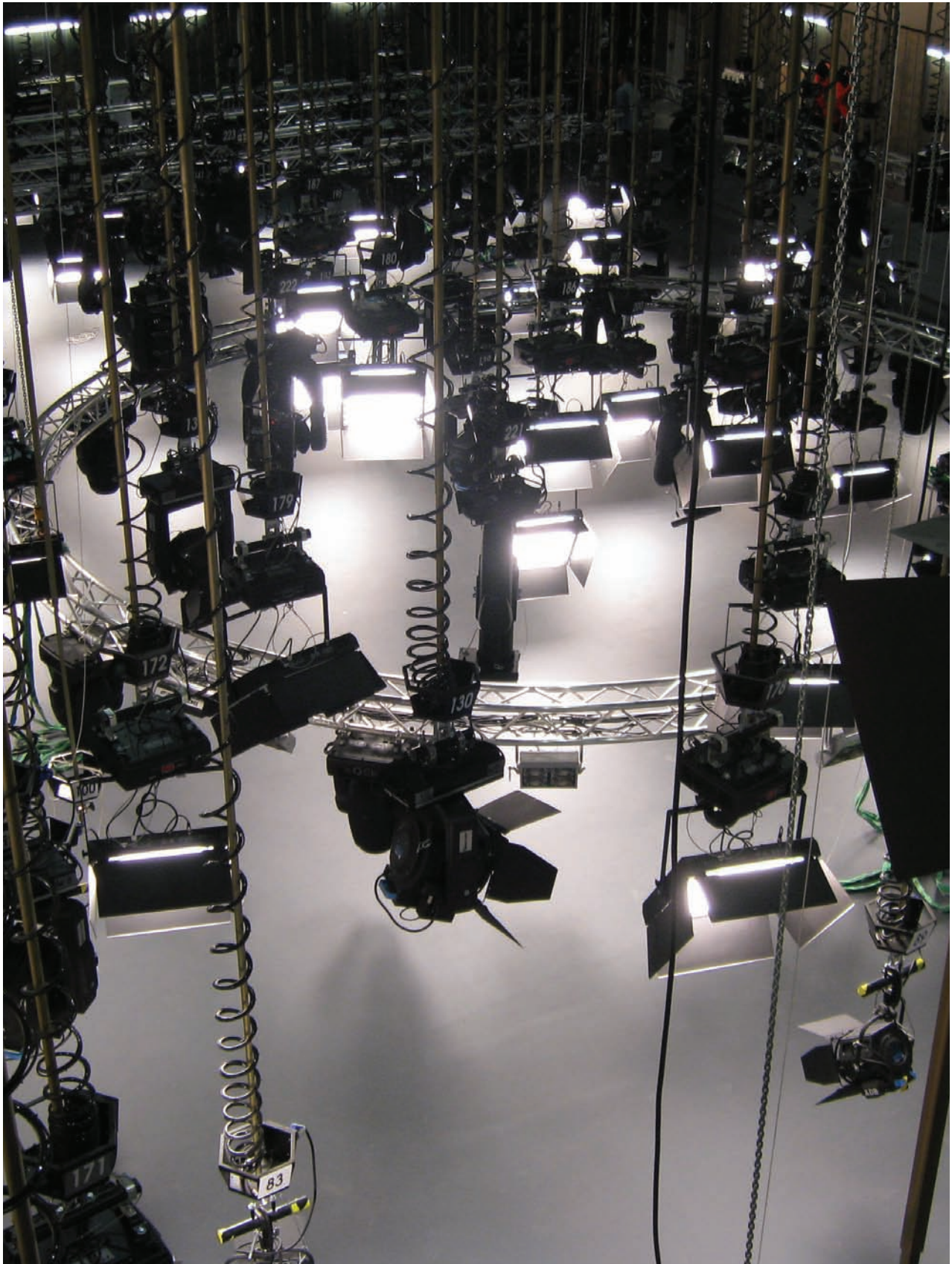



Your Partner for Light

ADB
Lighting Technologies

Belgium N.V. ADB-TTV Technologies S.A.
Group Headquarters
Leuvensesteenweg 585
B-1930 Zaventem
Tel: +32 (0)2.709.32.11
Fax: +32 (0)2.709.32.80
E-Mail: adb@adblighting.com

France ADB S.A.S.
Sales Office
92, Avenue Jean Jaurès
F-92120 Montrouge
Tel: +33 (0)1.41.17.48.50
Fax: +33 (0)1.42.53.54.76
E-Mail: adb.fr@adblighting.com

France ADB S.A.S.
Factory & Group Logistics Centre
Zone industrielle Rouvroy
F-02100 Saint-Quentin
Tel: +33 (0)3.23.06.35.70
Fax: +33 (0)3.23.67.66.56
E-Mail: adb.fr@adblighting.com

www.adblighting.com